



GENESIS G90

Thank you for purchasing this cclC (Connected Car Integrated Cockpit)

This user's manual explains how to use the cclC.
Before using the product, read the contents of this user's manual carefully and use this product safely.

- The screens shown in this manual may differ with the actual screens of the product.
- The design and specification of this product may change without prior notification for product improvement.
- When transferring the vehicle to another individual, include this user's manual so that the next driver can continue its use.



TABLE OF CONTENTS

TABLE OF CONTENTS	3
-------------------	---

START

NAME OF EACH COMPONENT	12
HEAD UNIT.....	12
FRONT SEAT CONTROL KEY.....	14
REAR SEAT CONTROL KEY.....	16
STEERING WHEEL REMOTE CONTROL (RIGHT).....	18
STEERING WHEEL REMOTE CONTROL (LEFT).....	20
BASIC CONTROLS	21
TURNING THE SYSTEM ON.....	21
TURNING THE SYSTEM OFF.....	22
ADJUST AV OR VOLUME.....	22
AV ON/OFF.....	22
ADJUSTING THE VOLUME.....	22
RESETTING THE SYSTEM.....	23
USING THE CONTROLLER AND TOUCHPAD.....	23
USING THE TOUCH SCREEN.....	24
BASIC CONTROLS OF HOME SCREEN	25
EDITING HOME SCREEN.....	26

NAVIGATION

GETTING STARTED WITH NAVIGATION	28
GENERAL INFORMATION OF NAVIGATION USE.....	28
NAVIGATION USE RESTRICTIONS.....	28
WHAT IS GNSS?.....	29
ABOUT SATELLITE SIGNALS.....	29
RECEIVING SATELLITE SIGNALS.....	29
MAP SCREEN	30
OPERATING NAVIGATION	32
STARTING NAVIGATION.....	32
DISPLAYING CURRENT LOCATION... ..	32
SIMPLE NAVIGATION FUNCTION.....	32
CHANGING MAP VIEW.....	33
ZOOM IN/OUT ON THE MAP.....	34
SWITCHING MAP SCALE.....	34
MANUALLY SWITCHING MAP SCALE	34
AUTOMATICALLY SWITCHING MAP SCALE.....	34
NAVIGATION VOLUME.....	35
NAVIGATION SETTINGS.....	37
PREVIOUS DESTINATIONS.....	37
POI.....	38
SETTING POI DISPLAY.....	38



SEARCHING FOR DESTINATION

39

SETTING DESTINATIONS BY SEARCH . 39

SETTING DESTINATIONS BY PREVIOUS
DESTINATIONS..... 41

SETTING DESTINATIONS BY POI 42

SETTING DESTINATIONS BY SAVED
PLACES 43

ADDING MY PLACES 44

EDITING SAVED MY PLACES 45

DELETING SAVED MY PLACES..... 46

MANAGING MY DATA WITH USB..... 47

SETTING DESTINATIONS BY GENESIS
RETAILERS..... 49

SETTING DESTINATIONS VIA SCROLL. 50

USING THE ROUTE MENU 51

STOP GUIDANCE/RESUME GUIDANCE 51

CANCEL ROUTE..... 51

ROUTE OPTIONS..... 52

EDIT ROUTE 53

ADD WAYPOINTS 53

DESTINATION/WAYPOINTS MAP VIEW
AND DELETE..... 54

CHANGE ROUTE ORDER..... 54

ROUTE OVERVIEW..... 55

ROUTE INFORMATION/AVOID..... 56

DESTINATION INFO..... 57

GENESIS CONNECTED SERVICES

GENESIS CONNECTED
SERVICES 59

BEFORE USING GENESIS CONNECTED
SERVICES 59

WHAT IS GENESIS CONNECTED
SERVICES?..... 59

WHAT IS TELEMATICS?..... 59

REGARDING WIRELESS SIGNAL

TRANSMISSION AND RECEPTION .59

GENESIS CONNECTED SERVICES MENU
60

WEATHER 61

CALENDAR..... 62

VEHICLE DIAGNOSTICS..... 63

MAINTENANCE 64

CONNECTED SERVICES SETTINGS..... 65

GENESIS CONNECTED SERVICES

FEATURES 68

SAFETY..... 68

CAR CARE 69

REMOTE SERVICE 70

VEHICLE SAFEGUARD..... 71

DATA SERVICES

DATA SERVICES 74

TRAFFIC INFORMATION 75

FUEL PRICES 76

DOPPLER RADAR 77

DRIVER ASSISTANCE

DRIVER ASSISTANCE 79



MEDIA

PLAYING USB 83

PLAYING USB MUSIC	83
PAUSE/PLAY MUSIC	83
PLAY PREVIOUS/NEXT MUSIC	83
FORWARD/REVERSE SEARCH MUSIC	84
SEARCH PREVIOUS/NEXT MUSIC . . .	84
VIEWING LIST	85
SHUFFLE	86
REPEAT	87
SONGS FOR THIS ARTIST	88
SONGS FOR THIS ALBUM	88
HIDE CURRENT FILE	88
SOUND SETTINGS	88
PLAYING USB VIDEO	89
PAUSE/PLAY FILE	89
FULL SCREEN MODE	90
PLAY PREVIOUS/NEXT FILE	90
FORWARD/REVERSE SEARCH FILE . .	90
SEARCHING PREVIOUS/NEXT FILE . .	91
MOVE BEFORE/AFTER 30 SECONDS .	91
VIEWING LIST	92
REPEAT	93
FILE INFORMATION	94
SUBTITLE SETTINGS	94
VOICE SETTINGS	94
SOUND SETTINGS	94
DISPLAY SETTINGS	94

PLAYING BLUETOOTH AUDIO 95

ACTIVATING BLUETOOTH AUDIO MODE	95
PAUSE/PLAY MUSIC	96
PLAY PREVIOUS/NEXT MUSIC	96
CHANGE DEVICE	97
SOUND SETTINGS	97

PLAYING SOUNDS OF NATURE

98

ACTIVATING SOUNDS OF NATURE MODE	98
SOUND SETTINGS	98

PLAYING PHONE PROJECTION

99

ACTIVATING PHONE PROJECTION MODE	99
---	-----------

RADIO

LISTENING TO RADIO 102

ACTIVATING RADIO MODE	102
SELECTING THE RADIO STATION . . .	103
MANUALLY SELECTING A RADIO	
STATION	103
AUTOMATICALLY SELECTING A RADIO	
STATION	103
RADIO STATION PRESET LIST	103
RADIO STATION FAVORITES	104
ADDING TO PRESETS	104
DELETING THE PRESETS	104
STATION LIST	105
SCANNING RADIO STATIONS	106
SHOW RADIO TEXT	107
SOUND SETTINGS	107

LISTENING TO HD RADIO™ 108

ACTIVATING HD RADIO™ MODE . . .	108
--	------------

LISTENING TO SIRIUSXM™

RADIO 109



ACTIVATING SIRIUSXM™ MODE	109
SELECTING SIRIUSXM CHANNEL	110
MANUALLY SELECTING A CHANNEL	110
SIRIUSXM CHANNEL FAVORITES	110
ADDING CHANNEL TO PRESETS . . .	110
DELETING CHANNEL FROM THE PRESETS	111
CATEGORY LIST	112
ENTER CHANNEL NUMBER	113
SUBSCRIPTION STATUS	113

PHONE

BLUETOOTH	115
BLUETOOTH WIRELESS TECHNOLOGY	115
WHAT IS BLUETOOTH WIRELESS TECHNOLOGY?	115
PRECAUTIONS FOR SAFE DRIVING .	115
CAUTIONS UPON CONNECTING BLUETOOTH PHONE	116
PAIRING AND CONNECTING THE UNIT AND A BLUETOOTH PHONE	117
WHEN NO PHONES HAVE BEEN PAIRED	117
WHEN A PHONE IS ALREADY PAIRED	119
CHANGE DEVICE	122
CANCELLING DEVICE CONNECTION . .	122
DELETING DEVICE	123
MAKING PHONE CALLS	124
MAKING PHONE CALLS BY ENTERING THE NUMBER	124
MAKING PHONE CALLS VIA SPEED DIAL	125
MAKING PHONE CALLS VIA RE-DIAL	126
RECEIVING PHONE CALLS	126
REJECTING PHONE CALLS	127

RESPONDING TO INCOMING CALL WITH TEXT	128
SWITCHING CALLS TO MOBILE PHONE/ HANDS-FREE	129
HANGING UP CALLS	130
USING CALL HISTORY	131
DOWNLOADING CALL HISTORY	131
CALLING CALL HISTORY	132
USING CONTACTS	133
DOWNLOADING CONTACTS FROM THE MOBILE PHONE	133
SEARCHING IN CONTACTS	134
USING DIAL SCREEN	135
USING MESSAGE	137
CHECKING NEW MESSAGES	137
CHECKING MESSAGE INFORMATION	138

SYSTEM

VEHICLE SETTINGS	140
DRIVE MODE	140
ACTIVE SOUND DESIGN (IF EQUIPPED) .	141
HEAD-UP DISPLAY	142
CLUSTER	143
CLIMATE	144
SEAT	145
LIGHTS	146
DOOR	147
DIGITAL KEY	148
CONVENIENCE	149



NAVIGATION SETTINGS	150	ADJUST VIDEO COLOR	172
MAP	150	ASPECT RATIO	173
DISPLAY	151	REAR DISPLAY ON/OFF (IF EQUIPPED)	174
GUIDANCE	152	KEEP AUDIO SYSTEM ON WHEN VEHICLE TURNS OFF	174
OTHERS	153		
SOUND SETTINGS	154	SCREEN THEME/LAYOUT SETTINGS	175
ADJUSTING THE SOUND EFFECT (IF EQUIPPED)	154	GRAPHIC THEMES	175
PREMIUM SOUND	156	VEHICLE EXTERIOR COLOR	175
TONE	157	FONT SIZE	176
POSITION	158	CLUSTER THEME SELECTION	177
GUIDANCE	159	SCREEN SAVER	177
ACTIVE SOUND DESIGN (IF EQUIPPED) . 160		CLUSTER WIDGET	178
NAVIGATION VOLUME CONTROLS ..	161	BUTTON/TOUCH PAD SETTINGS	179
RADIO NOISE	161	CUSTOM BUTTON	179
DRIVER ASSISTANCE	162	MODE BUTTON (STEERINGWHEEL) ..	181
CONNECTED DEVICE VOLUMES	163	NAVIGATION VOLUME CONTROLS ..	181
DEVICE CONNECTIONS SETTINGS	164	HOME BUTTON	182
DEVICE CONNECTIONS	164	CLIMATE TOUCHSCREEN HAPTIC INTENSITY	183
MESSAGE NOTIFICATION	165	GENESIS CONTROLLER	183
PREDEFINED MESSAGES	166	LOCK REAR CONTROLLERS	184
BLUETOOTH VOICE PROMPTS	167	GENERAL SETTINGS	185
PRIVACY MODE	168	SYSTEM INFORMATION CHECKING ..	185
RR SEAT PRIVACY MODE	168	SOFTWARE INFORMATION	185
BLUETOOTH SYSTEM INFORMATION	169	UPDATE	185
PHONE PROJECTION SETTINGS	169	SYSTEM INFORMATION	186
DISPLAY SETTINGS	170	DATE/TIME	187
ILLUMINATION	170	LANGUAGE	188
BLUE LIGHT FILTER	171	KEYBOARD	189
		UNITS	189



MEDIA OPTIONS	190	MEMO	206
RESET	190	DELETING VOICE MEMO	207
USER PROFILE SETTINGS	191	SAVING A VOICE MEMO TO USB ...	208
CHANGE USER PROFILE SETTINGS ..	191	USING VOICE RECOGNITION	
CHANGE USER	192	SYSTEM	209
VOICE RECOGNITION SETTINGS	193	WHAT IS VOICE RECOGNITION? ...	209
CONNECTED SERVICES		VOICE RECOGNITION FEATURES BY	
SETTINGS	194	LANGUAGE	209
CONNECTED SERVICE	194	OPERATING VOICE COMMANDS ...	210
UPDATE		CONDITION FOR VOICE COMMANDS	
WIRELESS UPDATE	196	SYSTEM	210
USB UPDATE	199	STARTING VOICE RECOGNITION ..	211
		SKIPPING PROMPT MESSAGES ...	211
		ENDING VOICE RECOGNITION ...	211
		ADJUSTING VOICE RECOGNITION	
		VOLUME	211
		VOICE RECOGNITION COMMANDS LIST	
		212	
		USING REAR VIEW	
		MONITOR(RVM) - OPTION	215
		ABOUT RVM	215
		OPERATING RVM	215
		USING SURROUND VIEW	
		MONITOR(SVM) - OPTION	216
		ABOUT SVM	216
		OPERATING FRONT SVM	216
		OPERATING REAR SVM	218
		CAMERA SETTINGS	220
		VIEWING CAMERA ON THE REAR SEAT .	
		220	
		WARNING DISPLAY	221
USING PHONE PROJECTION	202	CLIMATE	222
WHAT IS ANDROID AUTO/APPLE		OPERATING CLIMATE	222
CARPLAY?	202	OPERATING REAR CLIMATE	225
USING ANDROID AUTO/APPLE CARPLAY			
204			
USING VOICE MEMO	205		
CREATING A VOICE MEMO	205		
RUNNING VOICE MEMO	206		
PAUSE/PLAY VOICE MEMO	206		
PLAY PREVIOUS/NEXT VOICE MEMO	206		
FORWARD/REVERSE SEARCH VOICE			



QUIET MODE 227

MANUAL 228
 ONLINE MANUAL (NAVIGATION SYSTEM) 228
 VEHICLE QUICK GUIDE 228
 HANDWRITING MANUAL 229

SEAT 230

NOTIFICATION 231

VALET MODE 232

3D SETUP 233

CLUSTER 234
 SWITCHING GAUGE 234
 SWITCHING VIEW MODE 235
 CLUSTER WIDGET 236
 WARNING LIGHT 236

HUD (HEAD-UP DISPLAY) 237
 SETTINGS HUD VIEW 237
 SETTINGS HUD DISPLAY INFORMATION 237

BLUETOOTH HEADPHONES 238

HEADPHONE CONNECTION (IF EQUIPPED) 238

MOOD CURATOR (IF EQUIPPED) 239
 OPERATING MOOD CURATOR 239

REFERENCE

THE INFORMATION ABOUT A OWNER’S MANUAL 242
 ABOUT THIS OWNER’S MANUAL . . . 242
 THE SYMBOL USED IN THIS OWNER’S MANUAL 242

PRECAUTIONS FOR SAFETY 243
 NOTATIONS USED WITHIN THIS USER’S MANUAL 243
FCC NOTICE (FOR USA) 247
 FCC RADIO FREQUENCY INTERFERENCE REQUIREMENTS (FOR UNII DEVICES) 247
 FCC RF RADIATION EXPOSURE STATEMENT 247
INDUSTRY CANADA STATEMENT . . . 248
 IC RADIATION EXPOSURE STATEMENT . 248
 RSS-247 REQUIREMENT (FOR CANADA) 248



GENERAL INFORMATION	249
CAUTIONS FOR THE USE OF USB . . .	249
PLAYABLE FILE STANDARD	250
MUSIC FILE INFORMATION	250
VIDEO FILE INFORMATION	250
BEFORE THINKING	
THE PRODUCT HAS	
MALFUNCTIONED	251
BEFORE YOU THINK THE	
PRODUCT IS DEFECTIVE	253
TROUBLESHOOTING	254
TRADEMARKS AND LICENSES	
256	
TRADE MARKS	256
NAVIGATION	258
SPECIFICATION	268
AV/NAVIGATION PRODUCT	
SPECIFICATION	268
OPEN SOURCE SOFTWARE	
NOTICE	270

START



NAME OF EACH COMPONENT

HEAD UNIT

The image of this product may be different from the actual product.

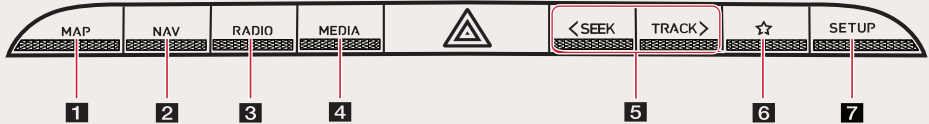

1 MAP button

- Moves to the map screen showing the current position of the vehicle.
- When the destination is set, the voice navigation starts on the map screen.

2 NAV button

- Moves to the navigation menu screen.
- Press and hold to move to the destination search screen.

3 RADIO button

- Activates radio mode.
- Press to change the radio mode.
- Press and hold to move to the media menu screen.

4 MEDIA button

- Press to switch between the media menu screen and the media playback screen.
- Press and hold to move to the media menu screen.

5 < SEEK/TRACK > button

- When it is pressed shortly
 - Radio mode: Plays the previous or next channel.
 - Media/Voice memo mode: Plays the previous or next file.
- When it is pressed and held
 - Radio mode: Changes the frequency until the button is released, then plays the frequency when released.
 - Media/Voice memo mode: Rewinds or fast-forwards the file.



6 ☆ (Custom) button

- User may select and use a desired feature with this button.
- Press and hold to move to the custom button settings screen.

7 SETUP button

- Moves to the settings screen.
- Press and hold to move to the general settings screen.

FRONT SEAT CONTROL KEY

The image of this product may be different from the actual product.

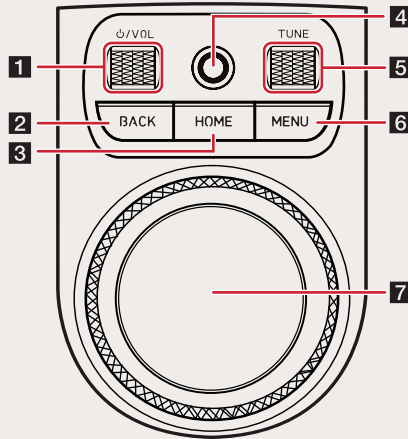

1 **⏻/VOL (Power/Volume) button**

- Press to turn AV on/off.
- Press and hold to turn on or off the display and the sound.
- Turns the wheel up/down to adjust the volume.

2 **BACK button**

- Press to move to the previous screen.
- Press and hold to move to the home screen.

3 **HOME button**

- Press to move to the home screen.
- Press and hold to move to the map screen.

4 **Finger scan sensor**

Use sensor to select the user profile or convenience features, etc.

5 **TUNE/FILE button**

- SXM mode: Turns the wheel up/down to search for channels. Press the wheel to select a channel.
- Radio mode: Selects a radio station.
- Media/Voice memo mode: Turns the wheel up/down to search for files. Press the wheel to select a file.
- Navigation: Turn up/down to change the map scale on the map screen.



6 MENU button

Press to display a pop-up menu for each mode.

7 Controller

- Use controller to move and select the menu as well as handwriting input.
- Use controller to change the map scale on the map screen.

REAR SEAT CONTROL KEY

The rear seat control function keys differ depending on the selected option. The images may differ from the actual components.

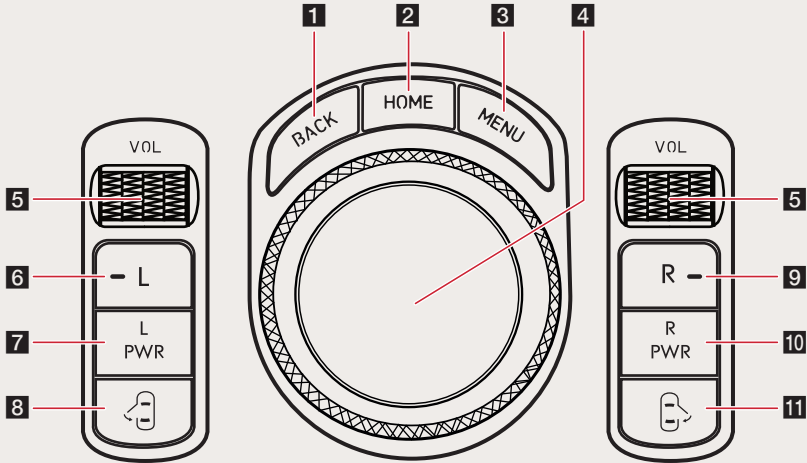

1 BACK button

- Press to move to the previous screen.
- Press and hold to move to the home screen.

2 HOME button

- Press to move to the home screen.
- Press and hold to move to the map screen.

3 MENU button

Press to display a pop-up menu for each mode.

4 Controller

- [Use controller to move and select the menu.](#)
- Use controller to change the map scale on the map screen.

5 VOL wheel button

- Turn the wheel up/down to adjust the volume.
- [Press the wheel button to turn the mute on or off.](#)



6 L button

Sets the rear seat control key to control the rear left display.

7 L PWR button

- Press the button to turn on or off the rear left display.
- Press and hold the button to turn the AV system on or off.

8 Automatic door button (Rear left)

Close the rear left door.

9 R button

Sets the rear seat control key to control the rear right display.

10 R PWR button

- Press the button to turn on or off the rear right display.
- Press and hold the button to turn the AV system on or off.

11 Automatic door button (Rear right)

Close the rear right door.

STEERING WHEEL REMOTE CONTROL (RIGHT)

The image of this product may be different from the actual product.

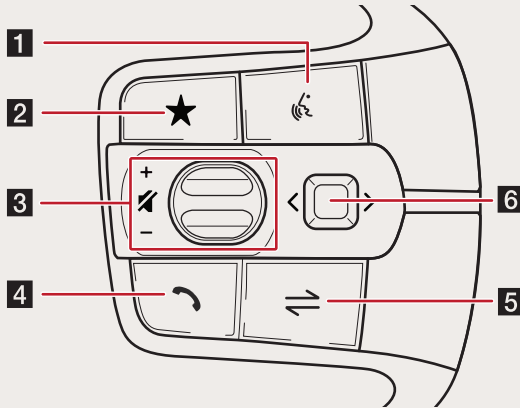

1 (Voice recognition) button

Press to activate voice recognition.

2 (Custom) button

- User may select and use a desired feature with this button.
- Press and hold to move to the custom button settings screen.

3 +/– (Tumbler) button

Turns the tumbler up/down to adjust the volume.

(Mute) button

Press the tumbler to turn mute on/off.

4 (Bluetooth call) button

- When there is no connected Bluetooth device, search for connectable Bluetooth devices and connect or add a new device.
- When connected to a Bluetooth device,
 - To move to the call history screen, press the button briefly.
 - To dial the last phone number of a connected Bluetooth device, press and hold the button.

5 MODE button

- Press to select the media mode to play.
- Press and hold to move to the mode button settings screen.

6 Optical touch pad

(You can use AVN control if the search mode in the split screen of the cluster is not.)

- When it is swiped
 - Radio mode: Moves to the previous or next frequency saved.
 - Media/Voice memo mode: Plays the previous or next file.
- When it is dragged
 - Radio mode: Changes the frequency until you lift your finger, and then search for the frequency.
 - Media/Voice memo mode: Rewinds or fast-forwards the file. (Except for the mode of sounds of nature)

NOTE

Check how to operate the optical touch pad.

- Swipe: Swipe the optical touch pad to up/down/left/right with your finger.
- Drag: Stop at the edge of the optical touch pad without passing it completely with your finger.

STEERING WHEEL REMOTE CONTROL (LEFT)

The image of this product may be different from the actual product.

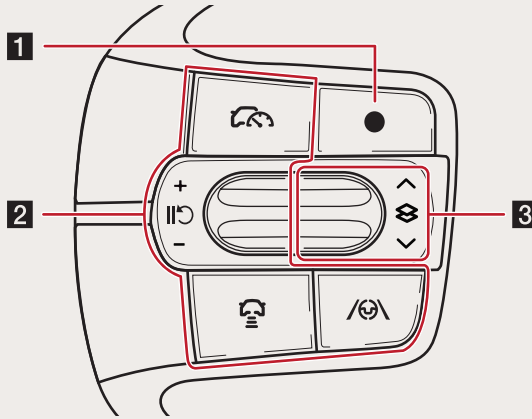

1 Custom button

- User may select and use a desired feature with this button.
- Press and hold to move to the custom button settings screen.

2 button

For details, refer to the vehicle instruction manual.

3 Tumbler button

Press or turn up/down the button to change the gauge style and view mode displayed on the cluster screen.

BASIC CONTROLS

TURNING THE SYSTEM ON

The images displayed on this system may differ from actual ones.

1. Press the engine start button. Once the system is turned on, the booting process will start and the safety warning page is displayed.

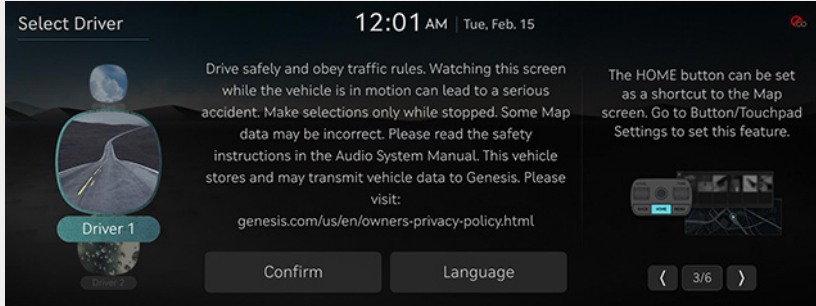

- Press [Language] to change the language of the system display.
 - Press [Driver 1], [Driver 2] or [Guest] to change the profile of system.
2. Press [Confirm].

! NOTE

- You cannot operate the system while it is booting up.
- It may take some time for all of the features of the system boot up.
- The safety warning page is displayed every time the ACC is turned on. (The user precaution may not be displayed when you turn the vehicle engine off and turn it on immediately.)
- The displayed warnings are related to safety, please read thoroughly and comply with the safety warnings.



TURNING THE SYSTEM OFF

Press and hold the power button on the front seat control key to turn off the system.

Press the power button on the front seat control key to turn on the system.

NOTE

- Check the volume when turning on the system.
- Before turning on the system, adjust the volume to a reasonable level.

ADJUST AV OR VOLUME

AV ON/OFF

Press the power button on the front seat control key to turn the AV on/off.

ADJUSTING THE VOLUME

Rotate the volume control knob on the front seat control key.





RESETTING THE SYSTEM

Resets the system when unexpected errors or problems occur.

1. After turning the vehicle off, press the start button once without pressing brake pedal.
2. **Press and hold** [MAP] button and the [SETUP] button on the head unit for 5 seconds.

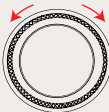

USING THE CONTROLLER AND TOUCHPAD

Controller	Details
	<p>Turn the controller clockwise/counterclockwise to move the list in the menu. Operate zoom in/zoom out on the map screen.</p>
	<p>Swipe up/down/left/right on touchpad to switch the menu.</p>
	<p>Press touchpad to select a menu. Enter character through handwriting input on a specific screen.</p>
	<p>Push the controller up/down/left/right/diagonal to move the menu and map location. Push and hold the controller to scroll the location on the map.</p>

USING THE TOUCH SCREEN

Press the desired menu on the screen to select a menu.

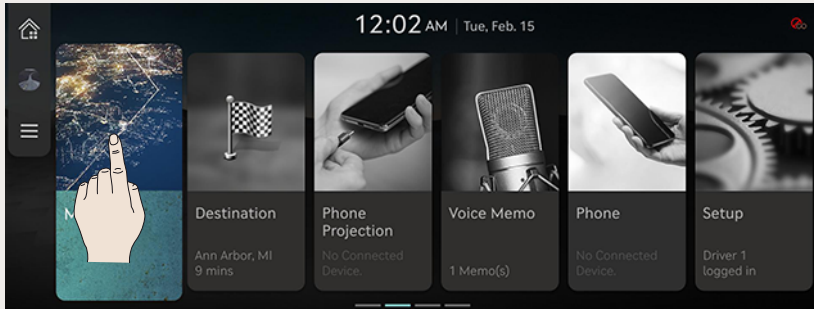

! NOTE

If you use the touch screen while driving, your attention to driving may be distracted.

BASIC CONTROLS OF HOME SCREEN

The images displayed on this system may differ from actual ones.

1. Press [HOME] on the front seat control key or press . The home screen opens.

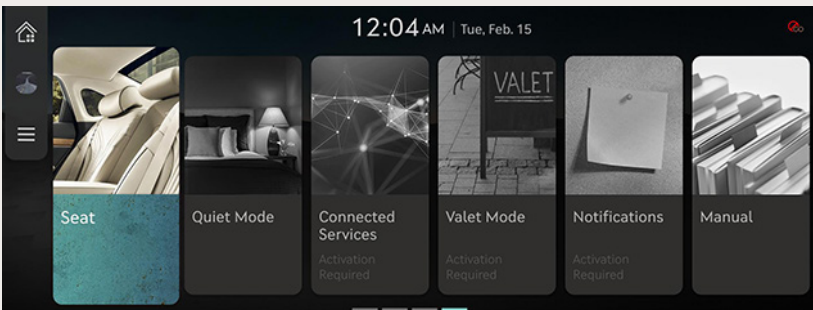
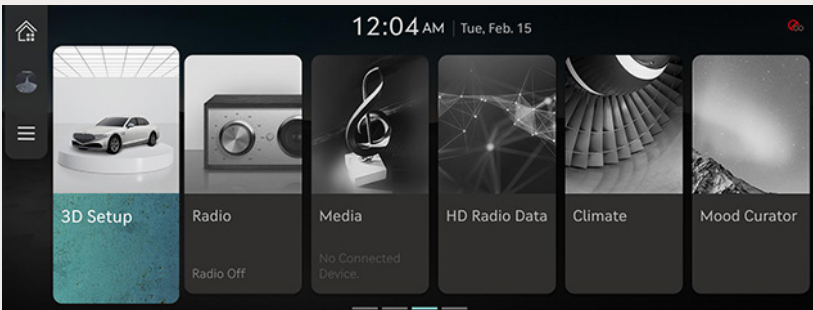
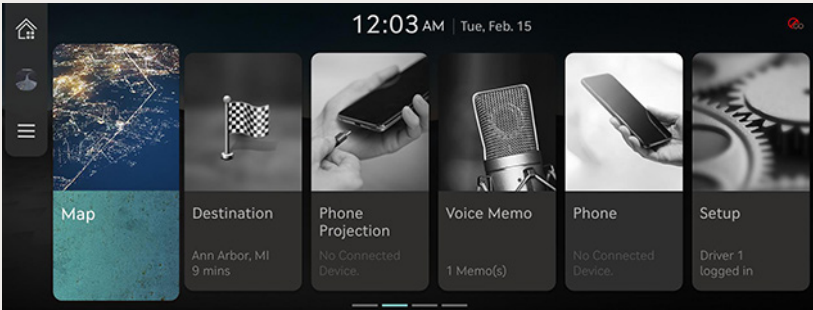

2. Select a desired menu on the home screen.
3. Follow-up controls are available for the selected menu.

EDITING HOME SCREEN

Press and hold the menu icon on the home screen to change the location.

1. Press and hold the menu icon on the home screen.

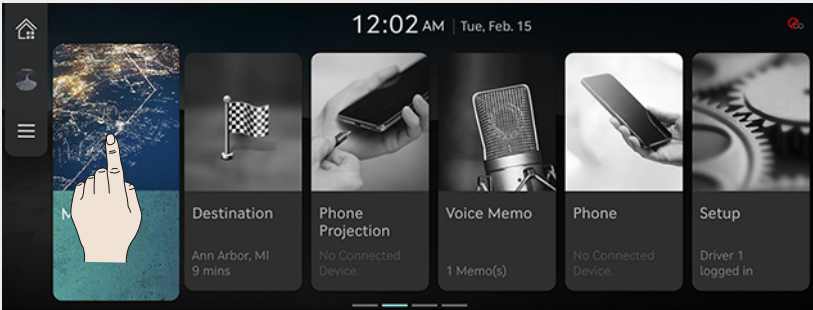

2. Change the position.

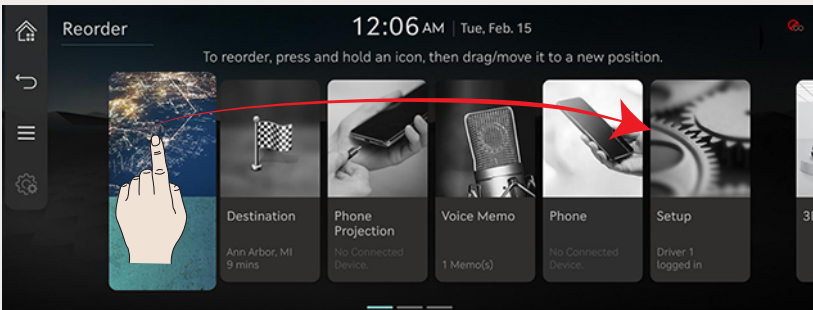

3. Press [↵].

NAVIGATION





GETTING STARTED WITH NAVIGATION

GENERAL INFORMATION OF NAVIGATION USE

NAVIGATION USE RESTRICTIONS

Please observe and comply with local traffic rules and regulations.

- For your safety, some functions cannot be operated while driving. Functions that cannot be operated will be disabled.
- The route guidance is a reference and it will take you to the vicinity of your destination. The highlighted route is not always; the shortest distance, the least congested, and in some cases, might not be the fastest route.
- Road, name, and POI information may not always been completely updated. Some locations may not include up to date information.
- The car location mark does not always indicate your exact location. This function uses GPS information, various sensors, and road map data to display the current location. However, errors in displaying your location may occur if the satellite is transmitting inaccurate signals or two or less satellite signals are being received. Errors that occur in such conditions cannot be corrected.
- The car location mark may differ from the actual location if the map data is different from the actual road landscape, such as changes due to the construction of new roads. If such differences occur, driving for a short period of time will automatically correct the location of the vehicle through map matching or GPS information.



WHAT IS GNSS?

The GNSS(Global Navigation Satellite System) is a satellite-based navigation system made up of a network of 32 satellites placed into orbit by the Global Positioning System (GPS) of U.S.A, GLONASS of RUSSIA, etc.

GNSS works in any weather conditions, anywhere in the world, 24 hours a day.

There are no subscription fees or setup charges to use GNSS.

ABOUT SATELLITE SIGNALS

The navigation must receive satellite signals to operate.

If you are indoors, near tall buildings or trees, or in a parking lot, the navigation may not be able to receive satellite signals.

RECEIVING SATELLITE SIGNALS

Before the navigation checks your current location and finds a route, you must do the following steps:

1. Go outside to an area free from tall obstructions.
2. Turn on the navigation. Receiving satellite signals can take a few minutes.

MAP SCREEN

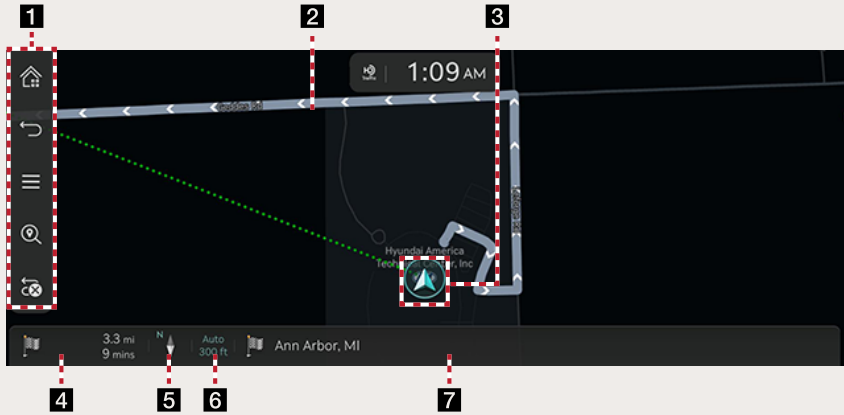

1

Moves to the home screen.



Moves to the home screen or the previous screen.





Displays the quick menu list.



Moves to search screen.



- Press [>] to cancel the currently set route.
- Press and hold [>] to stop the currently set destination.
- Press [>] to guide the paused route again.

2 Route display

Displays a route from the current vehicle location to the set destination.

GPS reception status display

- Reception: Marked in color
- Reception failure: Marked in gray color

3 Vehicle location mark

Displays the current vehicle location and the direction.

4 Estimated arrival time and remaining distance



Press to move to the destination information screen and change the arrival time format.

5 Map view

Set the view mode of navigation map.

6 Map scale display

Set scale settings as a fixed scale/automatic scale.

- : Fixed scale
- : Automatic scale (Scale changes based on the current vehicle speed)

7 Current location and destination name display

Displays the current location and the destination name.

OPERATING NAVIGATION

The navigation system displays various information on the screen.

STARTING NAVIGATION

1. Press [HOME] on the front seat control key or press [HOME]. The home screen opens.
2. Press [Map] on the home screen or press [MAP] on the head unit. The map screen opens.

DISPLAYING CURRENT LOCATION

Press [MAP] on the head unit to display the current vehicle location on the map screen.

SIMPLE NAVIGATION FUNCTION

Simple navigation functions are listed for easy access to frequently used functions.

Press the touchpad on the front seat control key to move to simple navigation function screen.

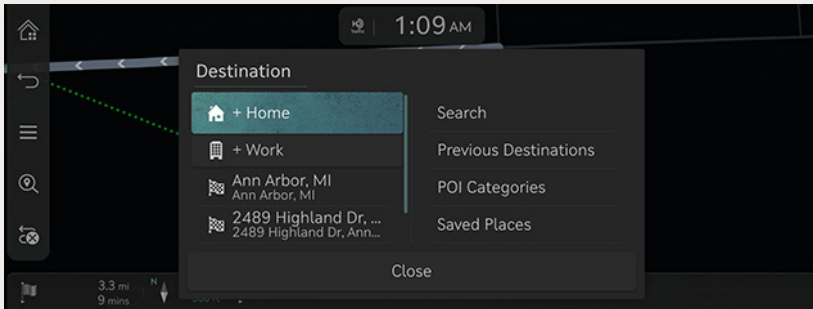

- [Home]: Recommends a route to home.
- [Work]: Recommends a route to workplace.
- Select previous destination to have a route advised to the selected destination.
- [Search]: Search a destination by entering the full name or initial, address or coordinates.
- [Previous Destinations]: Set previous destinations as a destination.
- [POI Categories]: Set the desired facilities as a destination.
- [Saved Places]: Set saved places as a destination.

CHANGING MAP VIEW

1. Press  on the map screen.

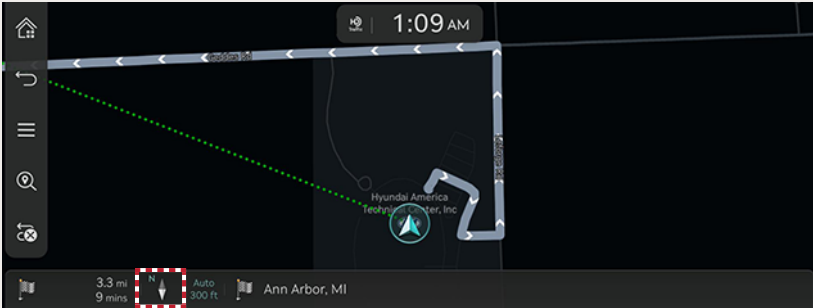

2. Press the desired button.

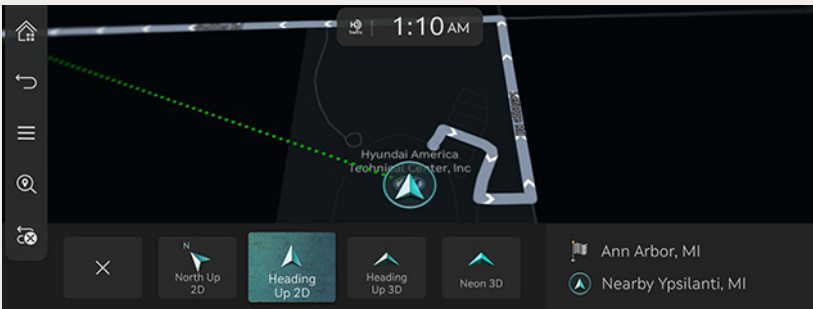

- [North Up 2D]: Displays the map based on the north direction.
- [Heading Up 2D]: Displays the map according to the vehicle direction.
- [Heading Up 3D]: Displays buildings in 3D on the map.
- [Neon 3D]: Displays the map in 3D neon style.

NOTE

The Neon screen changes according to the surrounding environment or GPS time.

ZOOM IN/OUT ON THE MAP

- Swipe your finger on the map screen to zoom in or out on the map.
- Rotate the controller left or right to zoom in or out on the map.

SWITCHING MAP SCALE



MANUALLY SWITCHING MAP SCALE

Rotate the controller on the front seat key to left/right or zoom in/out with your finger on the map screen to change the map scale.

AUTOMATICALLY SWITCHING MAP SCALE

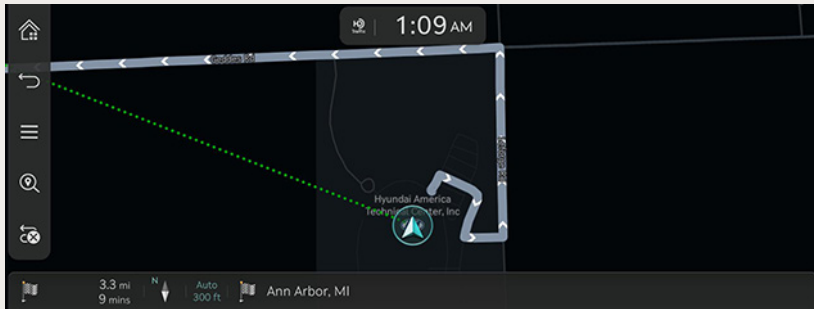
Press  to zoom in/out automatically on the map according to the driving speed of the vehicle.



- : Fixed scale
- : Automatic scale (Scale changes based on the current vehicle speed)

NAVIGATION VOLUME

1. Press the button at the bottom of the map screen.

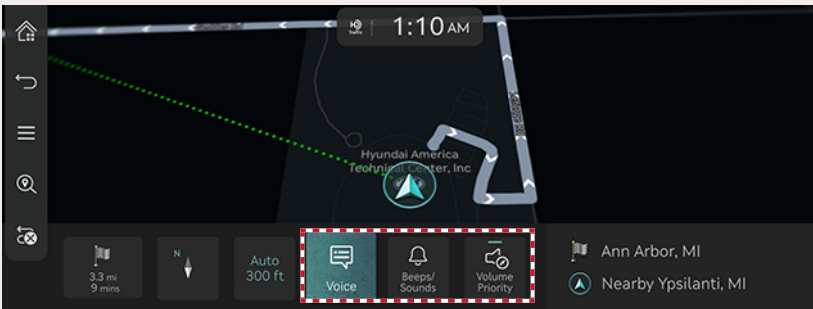
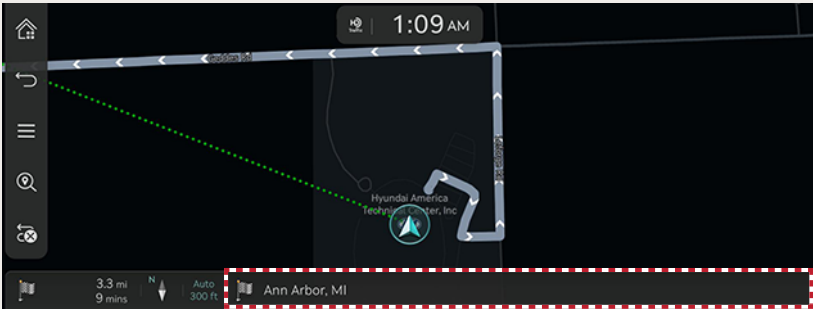

- [Voice]: Set the volume of the voice guidance.
- [Beeps/Sounds]: Set the volume of the beeps/sounds effect.
- [Volume Priority]: Media volume will be lowered during navigation guidance.

2. Select a [Voice] or [Beeps/Sounds].

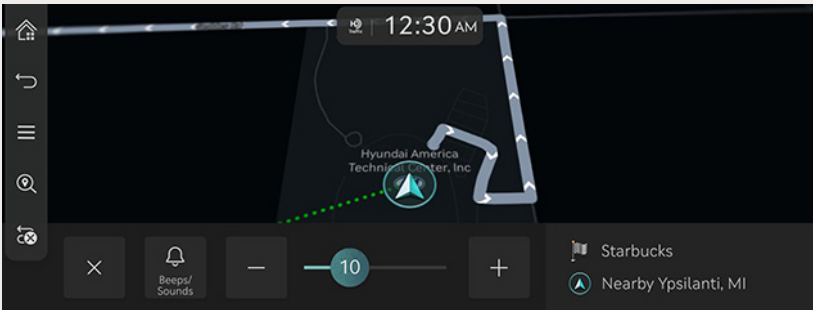
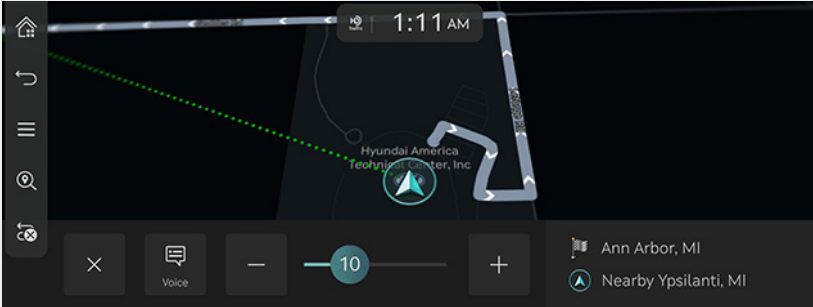

3. Select a desired button.

- [+]/[-]: Turn up/Turn down the navigation volume. Or drag the volume control bar to set the volume.
- [🗨️]/[🔔]: Voice guidance or sound effects are activated. You can mute by pressing the button.
- [🔕]: Voice guidance or sound effects are muted. You can activate it by pressing the button.
- [X]: Press the button to return to the previous screen.

NAVIGATION SETTINGS

1. Press  > [Navigation settings] on the map screen.

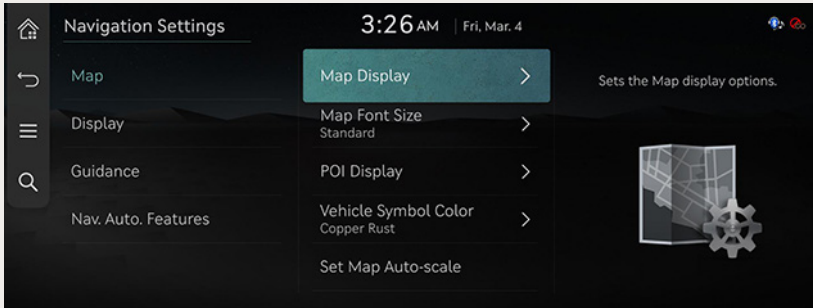

2. For more details, refer to the "Navigation settings".

PREVIOUS DESTINATIONS

At the start of navigation, the previous destinations and favorite destinations are automatically displayed on the pop-up screen for 10 seconds.

On the pop-up screen, press the desired destination and route to start the guidance. (Available only when the destination is not set)

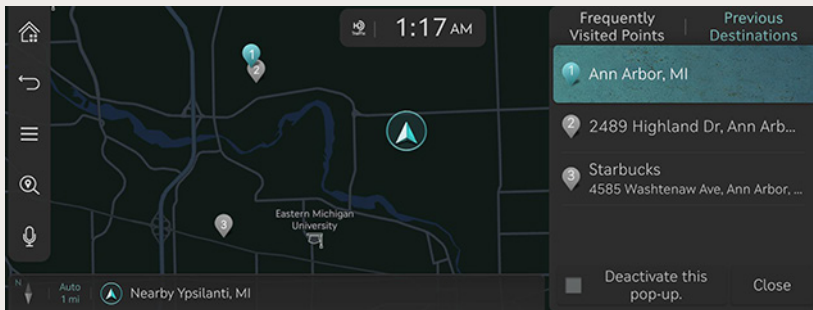

- [Frequently Visited Points]: Shows frequently visited destinations.
- [Previous Destinations]: Shows previous destinations.

NOTE

To deactivate the pop-up screen, select [Deactivate this pop-up].

To activate the pop-up screen, press [Setup] > [Navigation] > [Nav. Auto. Features] > [Previous Destination Settings] > [Show Previous Destinations after Navigation Start-up].

POI

SETTING POI DISPLAY

Set to display the POI category on the map screen.

1. Press  > [Nearby POIs] > [POI Display] on the map screen.

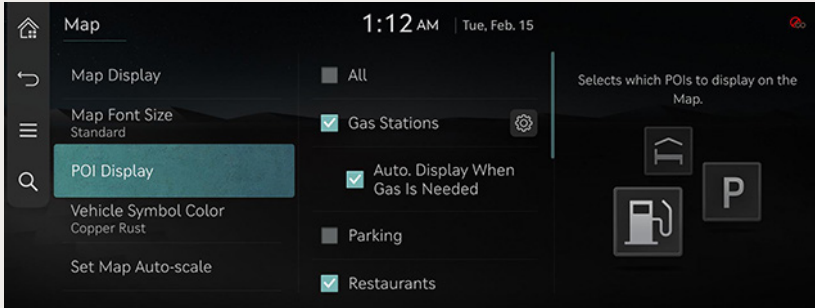

2. Select a facility to display on the map screen.

SEARCHING FOR DESTINATION

SETTING DESTINATIONS BY SEARCH

Set a destination by entering POI name, address or coordinates.

1. Press [Destination] > [Search] on the home screen.
Or press [📍] on the map screen.

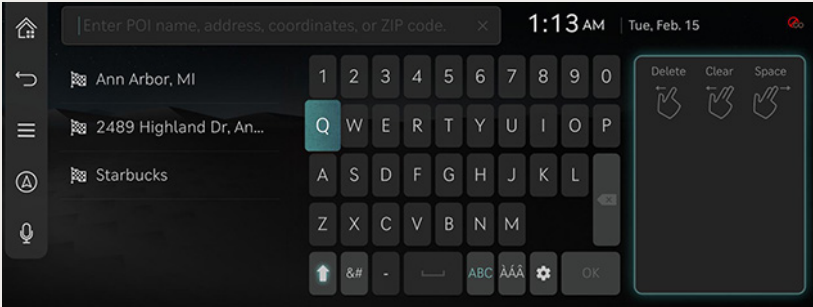

2. Enter a keyword.

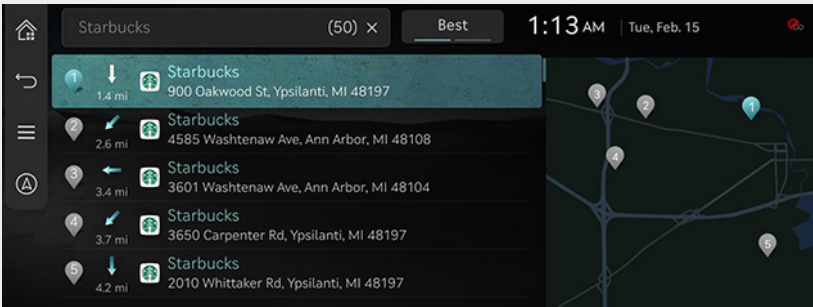

3. Press the desired location on the list.

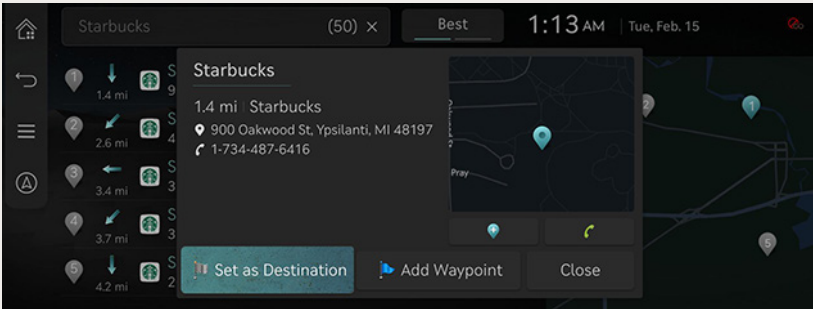

4. Select a desired button.

- [Set as Destination]: Set a destination.
- [Add Waypoint]: Add a waypoint after setting a destination.
- [📍]: Add the location to the saved places.
- [📞]: Make a phone call. If phone number is not saved or Bluetooth is not connected, the call is not available.

5. Press [Set as Destination].

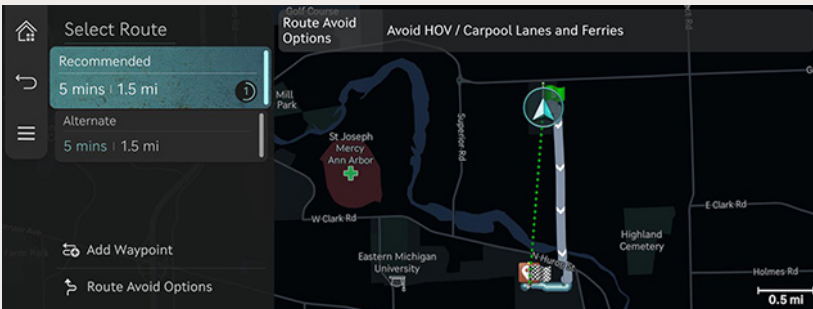

6. Select the desired route.

- [Recommended]: Guides the optimal route to the destination by considering the realtime traffic information, distance and cost.
- [Alternate]: Guides the alternative route to the destination.

SETTING DESTINATIONS BY PREVIOUS DESTINATIONS

Set the previous destinations as a destination.

1. Press [Destination] > [Previous Destinations] on the home screen.

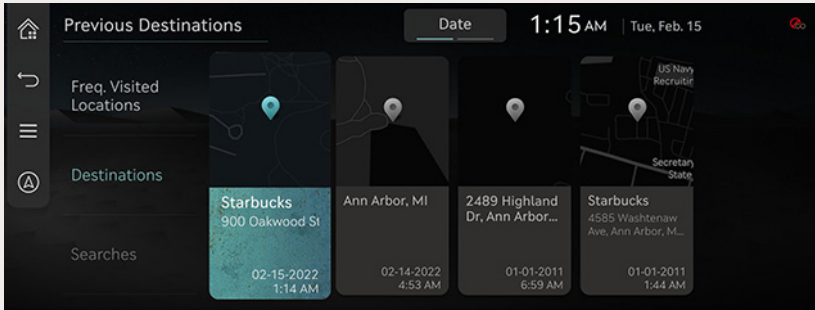

2. Press the desired destination from the list.
3. Refer to the step 4 to 6 of "Setting destinations by search" for next steps.

SETTING DESTINATIONS BY POI

Set a destination through various facility categories.

1. Press [Destination] > [POI Categories] on the home screen.
Or press  > [Nearby POIs] > [POI Categories] on the map screen.

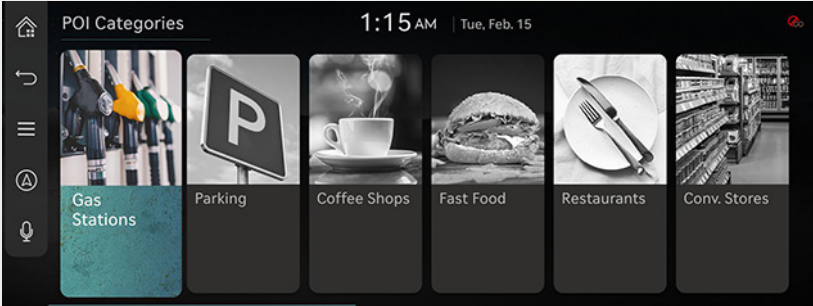

2. Press the desired facility.

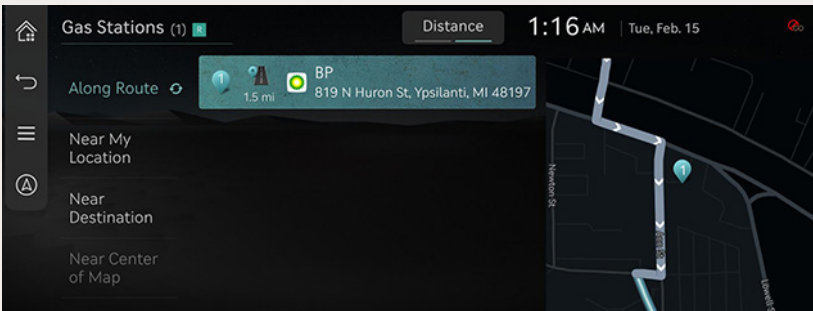

- [Along Route]: Search the facilities around the route.
 - [Near My Location]: Search the facilities around the current location.
 - [Near Destination]: Search the facilities around destination or waypoint.
 - [Near Center of Map]: Search the facilities around the selected location.
3. Refer to the step 4 to 6 of "Setting destinations by search" for next steps.

SETTING DESTINATIONS BY SAVED PLACES

Set the saved places as a destination.

1. Press [Destination] > [Saved Places] on the home screen.
2. Press [Saved Places].

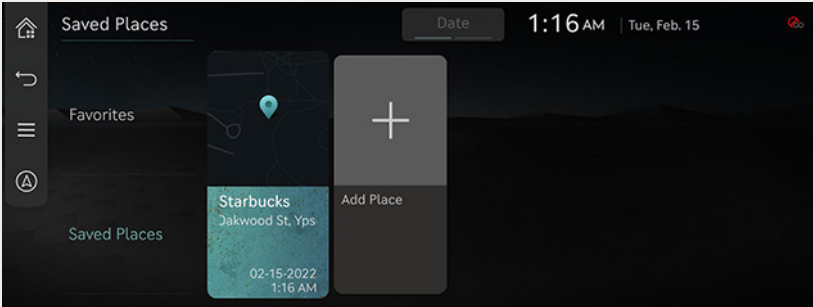

3. Select the desired destination from the list.
4. Refer to the step 4 to 6 of "Setting destinations by search" for next steps.

NOTE

Press [Name] or [Date] on the screen to change the sort method.

ADDING MY PLACES

Save the places you visit frequently.

1. Press [Destination] > [Saved Places] on the home screen.
2. Press [Saved Places].

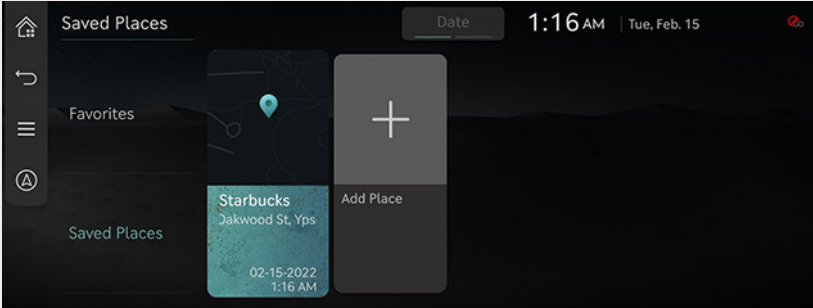

3. Press [+].
4. Use search menu to save the place.
5. Press [Save].

NOTE

You can save the desired place as a favorite

Press [Destination] > [Saved Places] > [Favorites] > [+] on the home screen. (Home, work, or favorite 1-3)

EDITING SAVED MY PLACES

1. Press [Destination] > [Saved Places] on the home screen.
2. Press [Saved Places].
3. Press  > [Edit].

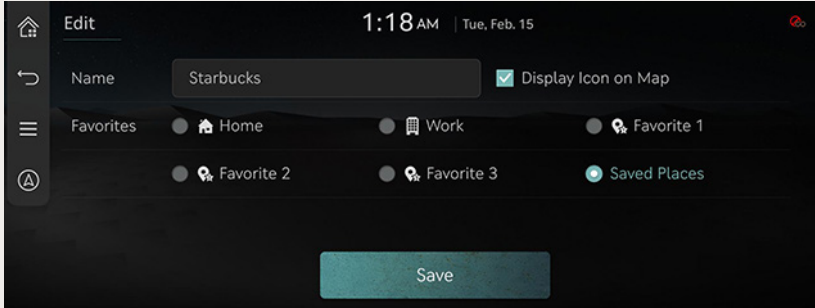

4. Select and edit a desired place.
 - [Name]: After editing the name, press [OK].
 - [Display Icon on Map]: Select to display the icon on the map.
 - [Favorites]: Select a favorite group to save the location.
5. Press [Save].

NOTE

You can edit a favorites.

Press [Destination] > [Saved Places] > [Favorites] >  > [Edit] on the home screen. (Home, work, or favorite 1-3)

DELETING SAVED MY PLACES

1. Press [Destination] > [Saved Places] on the home screen.
2. Press [Saved Places].
3. Press  > [Delete].

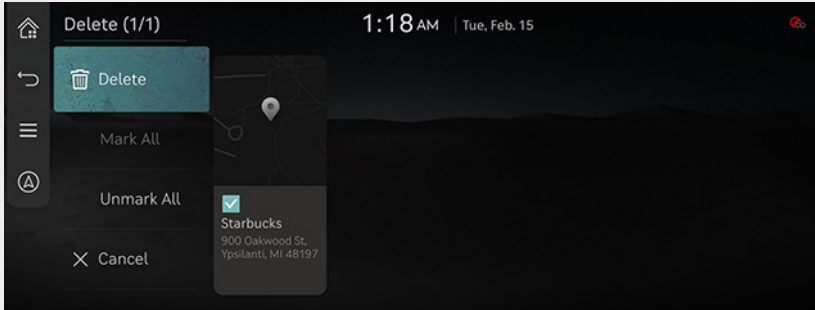

4. Select the desired place, and press [Delete].
 - [Mark All]: Selects all places.
 - [Unmark All]: Unmarks all places.
 - [Cancel]: Returns to the previous screen.

NOTE

You can delete a favorite.

Press [Destination] > [Saved Places] > [Favorites] >  > [Delete] on the home screen.
(Home, work, or favorite 1-3)

MANAGING MY DATA WITH USB

Importing saved places from USB memory

This function is used to import saved places in a USB memory.

1. Connect a USB memory to the USB port.
2. Press [Setup] > [Navigation] > [Nav. Auto. Features] > [User Data] > [Import Saved Location Info. from USB Device] on the home screen.
3. Press [Yes].
4. Press [OK], or press [View] to check imported places.

NOTE

- The number of data imported from USB may be limited by the number of saved places currently supported by the navigation system.
- If the data saved in the USB memory uses different coordinates from the ones used in the current system, the coordinates of saved locations may change.
- When importing a saved place in USB, the place saved in the navigation may be changed.
- Check if the data is imported well before using the navigation.
- Import/Export function may not be supported depending on the USB memory format type.
- FAT16, FAT32, exFAT, and NTFS are supported.
- Some USB memories may not be supported due to compatibility issues.



Exporting saved places to USB memory

This function is used to export saved places to a USB memory.

1. Connect a USB Memory to the USB port.
2. Press [Setup] > [Navigation] > [Nav. Auto. Features] > [User Data] > [Export Saved Location Info. to USB Device] on the home screen.
3. Press [Yes].

NOTE

When you export saved locations to USB, the existing saved location in USB is deleted.

SETTING DESTINATIONS BY GENESIS RETAILERS

Set a destination through Genesis retailers.

1. Press [Destination] > [GENESIS Retailers] on the home screen.

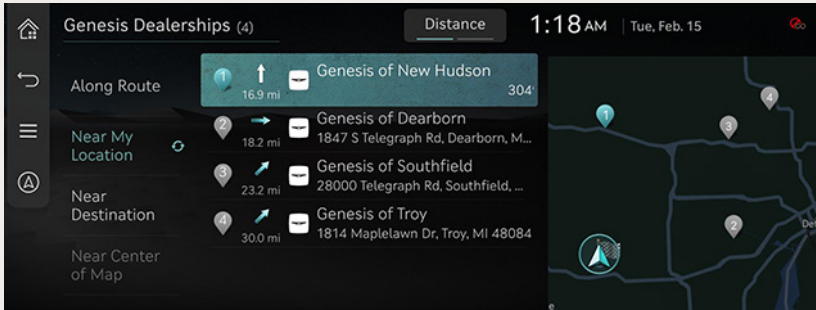



2. Press the desired place.
 - [Along Route]: Search the facilities around the route.
 - [Near My Location]: Search the facilities around the current location.
 - [Near Destination]: Search the facilities around destination or waypoint.
 - [Near Center of Map]: Search the facilities around the selected location.
3. Refer to the step 4 to 6 of "Setting destinations by search" for next steps.

SETTING DESTINATIONS VIA SCROLL

Set a destination on the currently displayed map.

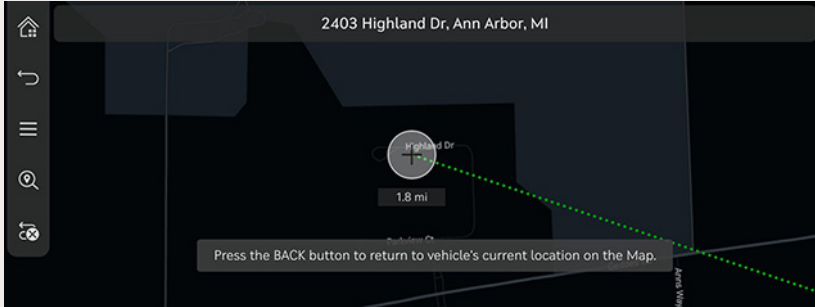
1. Tap and drag the map screen.
The selected location is displayed on the center of the screen and a scroll mark is displayed.



2. Press .
3. Refer to the step 4 to 6 of "Setting destinations by search" for next steps.

NOTE



- On the map screen, the current vehicle location is fixed and you can scroll to select the location.
- Press [MAP] on the head unit to return to the current location screen.
- When [Re-center Map Automatically] is set, it automatically returns to the current location after a certain period of time.
- When the map is moved by scrolling, the location name is displayed on the top of screen.



USING THE ROUTE MENU

STOP GUIDANCE/RESUME GUIDANCE

Stop or resume the route guidance.

1. Press and hold  on the map screen to stop route guidance.
2. Press  on the map screen to resume the route guidance.

CANCEL ROUTE

Cancel the route to the set destination.

Press  on the map screen. Or press  > [Cancel Route] on the map screen.

ROUTE OPTIONS

Various route options are available to search to the set destination.

1. Press  > [Route] > [Route Options] on the map screen.

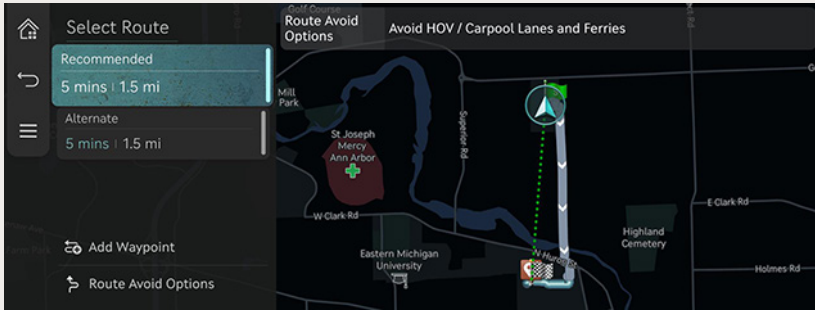

2. Select a desired route option.
 - [Recommended]: Guides the optimal route to the destination by considering the realtime traffic information, distance and cost.
 - [Alternate]: Guides the alternative route to the destination.
 - [Add Waypoint]: Edit the route by adding a waypoint.
 - [Route Avoid Options]: Set the route options you want to avoid.

NOTE

The options set by user may not be reflected depending on condition.

EDIT ROUTE

This function allows you to edit the currently set route.

Waypoints can be added/deleted/edited and the order can be changed.

ADD WAYPOINTS

After setting the destination, you can add up to 2 waypoints.

If 2 waypoints have already been added, delete the added waypoint and add it again.

1. Press  > [Route] > [Edit Route] on the map screen.

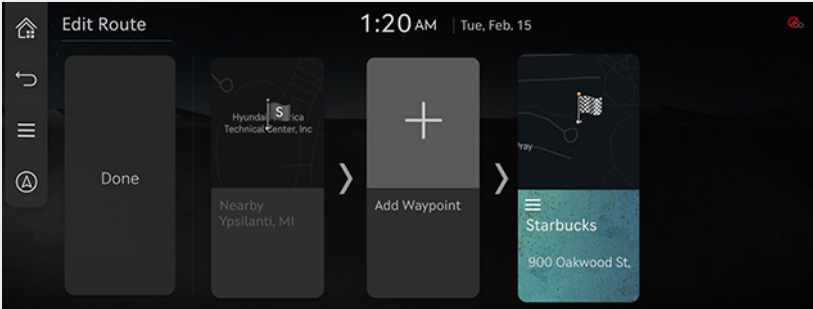

2. Press [+].
3. Set a waypoint by using search.

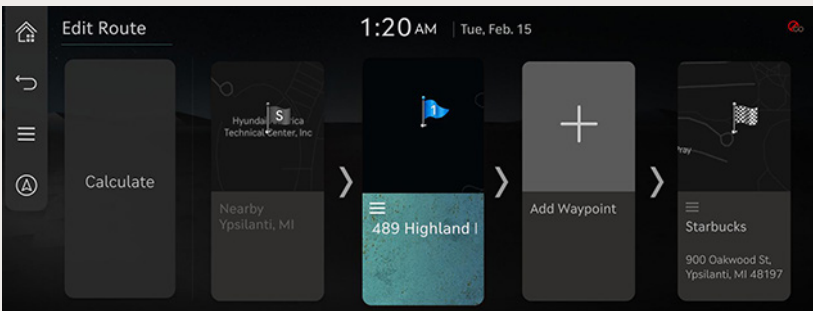

4. Repeat step 2 to 3 to add another waypoint.
5. Press [Calculate].

DESTINATION/WAYPOINTS MAP VIEW AND DELETE

1. Press  > [Route] > [Edit Route] on the map screen.
2. After pressing the waypoint or destination, press [Show Map] or [Delete].

CHANGE ROUTE ORDER

1. Press  > [Route] > [Edit Route] on the map screen.
2. After pressing the waypoint or destination, press [Reorder].

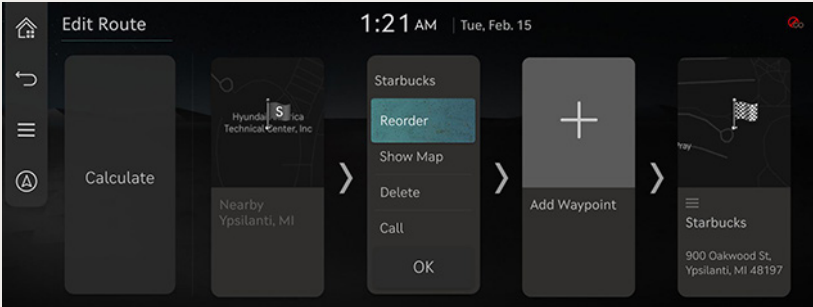

3. Drag and drop it to the desired order.

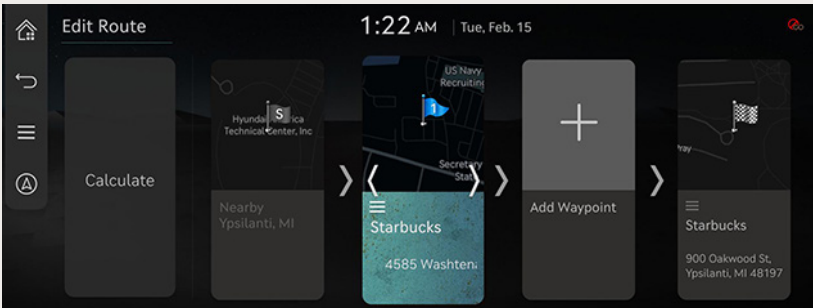

4. Press [Calculate].

ROUTE OVERVIEW

Check the route overview to the set destination.

Press  > [Route] > [Route Overview] on the map screen.

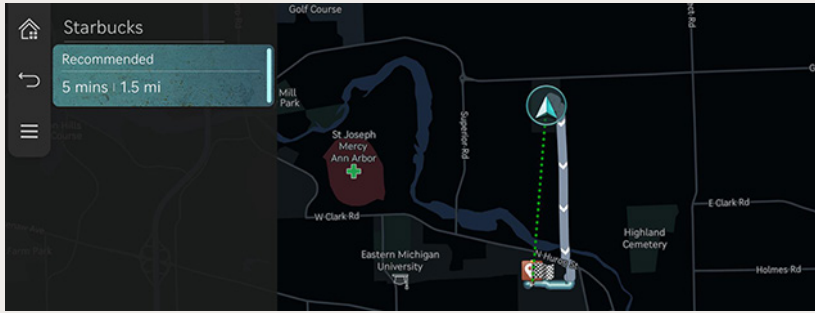

ROUTE INFORMATION/AVOID

Check the route information and search for new route by avoiding the selected road(s).

1. Press  > [Route] > [Route Information/Avoid] on the map screen.

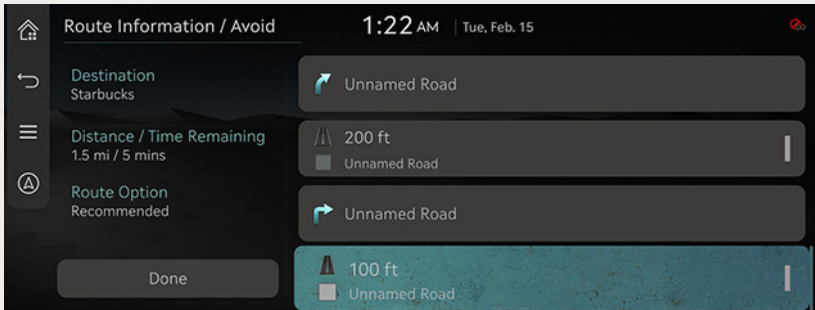

2. Select the road you want to avoid, and press [Reroute].
3. Press [Yes].

DESTINATION INFO

Shows the remaining distance, the estimated time required and the estimated time of arrival to the set destination.

1. Press  > [Route] > [Destination Info.] on the map screen.

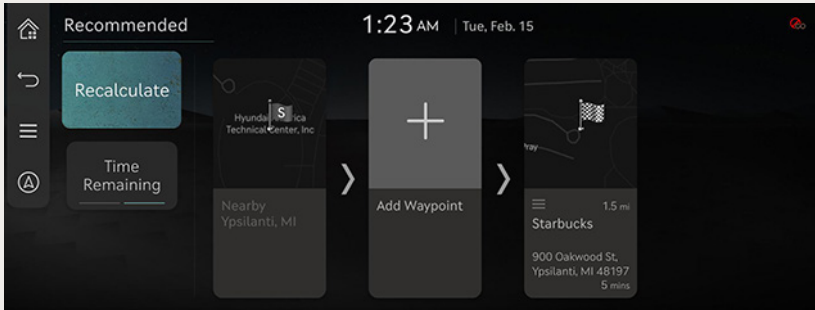

2. Select a desired information.
 - [Recalculate]: Re-search to the route to the currently set destination.
 - [Arrival Time]: Displays the estimated arrival time to the destination. You can change the setting by pressing the button to display the remaining time.
 - [Time Remaining]: Displays the estimated time required to arrive at the destination. You can change the setting by pressing the button to display the arrival time.

GENESIS CONNECTED SERVICES





GENESIS CONNECTED SERVICES

The Genesis connected services function is supported for vehicles purchased in the US. This function is not supported according to the vehicle.

BEFORE USING GENESIS CONNECTED SERVICES

WHAT IS GENESIS CONNECTED SERVICES?

The telematics service by Genesis connected services supporting not only the security, the diagnosis and the remote control, but also the more comfortable and driving experience through smartphone connection based on the most advanced IT system.

Experience smarter driving with Genesis connected services.

WHAT IS TELEMATICS?

The word “Telematics” stems from the combination of telecommunications and informatics. It refers to an information system that provides a variety of driving information through the builtin terminal by analyzing each symptom and driving state. This allows for a much safer and more comfortable driving experience.

REGARDING WIRELESS SIGNAL TRANSMISSION AND RECEPTION

The service can be limited depending the environment of mobile communication network operated by the mobile communication service provider.

Some impacts to the service connection and/or the transmission/reception of wireless data can be expected at the following locations:

- In tunnels
- Mountain areas or heavily forested roads
- Roads closes to cliffs
- Building concentrated area
- Roads passing under highway or overpasses
- Insides of buildings
- Shaded areas due to the service provider's policy on the network coverage

GENESIS CONNECTED SERVICES MENU

Genesis connected services features are available when the service is subscribed. Additional costs may occur by using Genesis connected services. Depending on the subscription plan, the available features may differ.

1. Press [Connected Services] on the home screen.

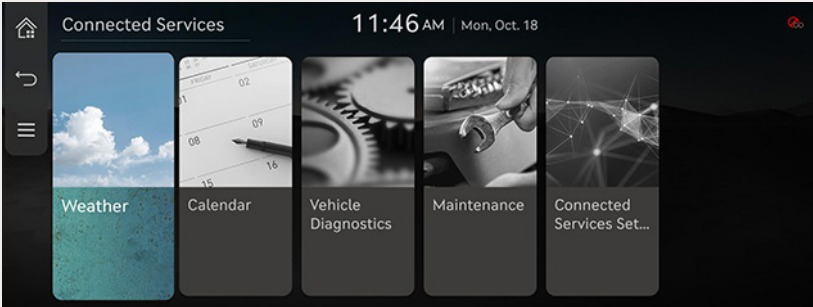

2. Select a desired item.

- [Weather]: Checks the weather information.
- [Calendar]: Checks the events of the connected calendar in the connected service app.
- [Vehicle Diagnostics]: Checks the abnormal state of the vehicle and check the diagnosis result.
- [Maintenance]: Checks the maintenance service.
- [Connected Services Settings]: Sets the connected services.

WEATHER

Based on the vehicle location, the current location weather information and the destination weather information set in the vehicle is provided in real time.

Press [Connected Services] > [Weather] on the home screen.

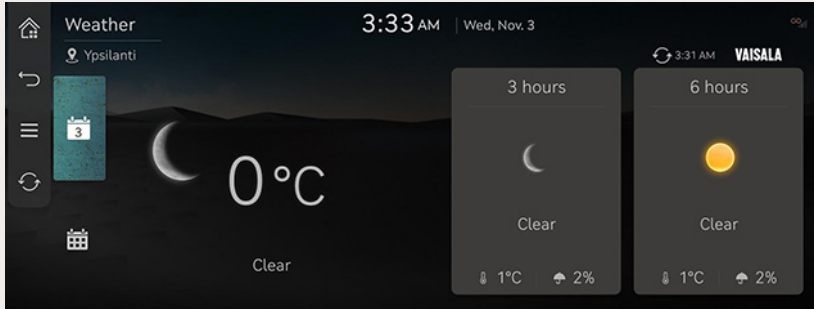

CALENDAR

videopage011

The customer's calendar (Google or iCloud) must be linked through the Genesis connected services app at first.

In the vehicle, you can check the schedule on the linked calendar and set a destination in the included location information.

Press [Connected Services] > [Calendar] on the home screen.

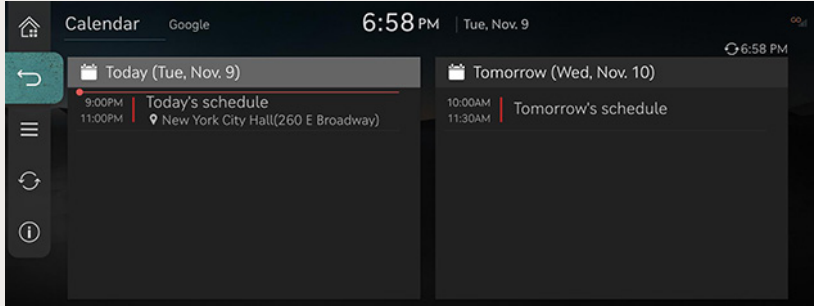

VEHICLE DIAGNOSTICS

videopage002

The vehicle diagnostics feature automatically performs diagnostics on your car when a warning light comes on the cluster panel and displays the details of the vehicle malfunction on the screen for the driver.

Press [Connected Services] > [Vehicle Diagnostics] on the home screen.

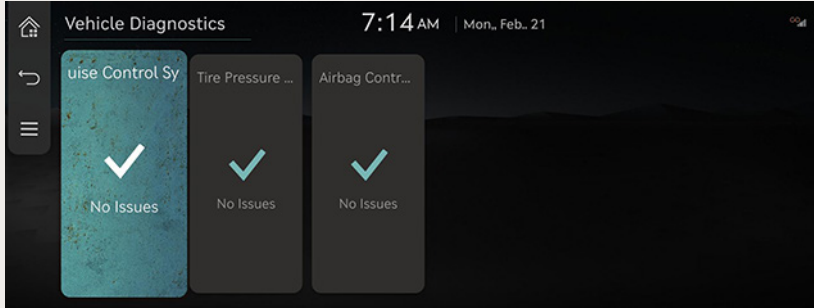

MAINTENANCE

Checks the maintenance service.

Press [Connected Services] > [Maintenance] on the home screen.

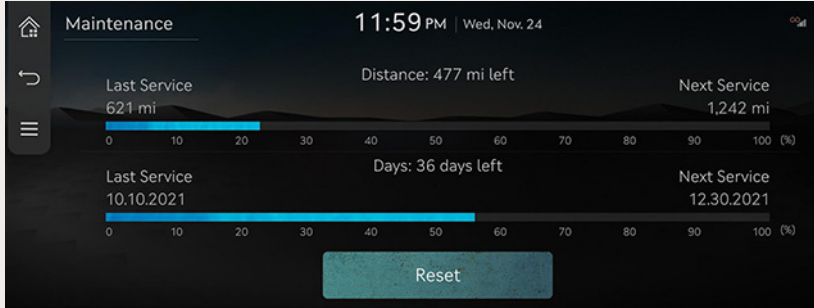

CONNECTED SERVICES SETTINGS

Service activation (when the service is not activated)

After you buy your car, you need to activate (register for) Genesis connected services to use any Genesis connected services features.

< USA >

1. Press [Connected Services] > [Connected Services Settings] > [Activate] on the home screen.

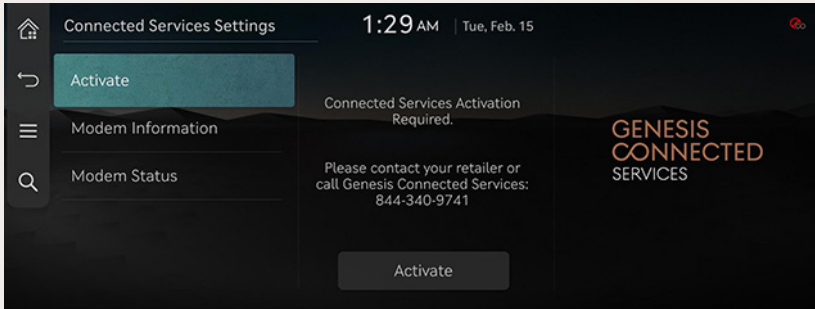

2. Press [Activate].

< Canada >

1. Press [Connected Services] > [Connected Services Settings] > [Feature Enrollment] on the home screen.

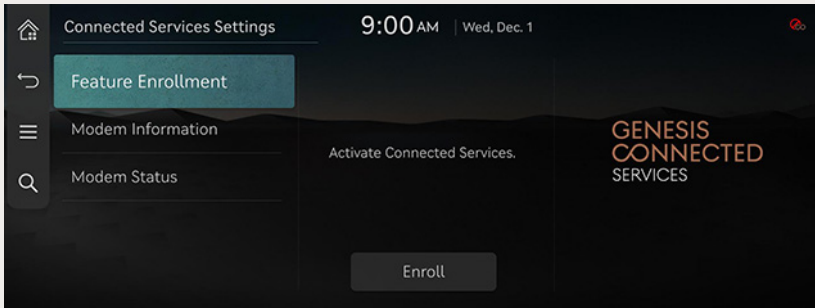

2. Press [Enroll].



 **NOTE**

- Activation may take up to five minutes.
- Do not turn the engine off while activation is in progress.
- If activation fails, please contact your authorized dealer.
- During service activation, the hard keys in the head unit do not work.

Service activation (when the service is expired)

If your services period is expired, the services features are not available.



Modem Information

Checks the modem information.

Press [Connected Service] > [Connected Services settings] > [Modem Information] on the home screen.

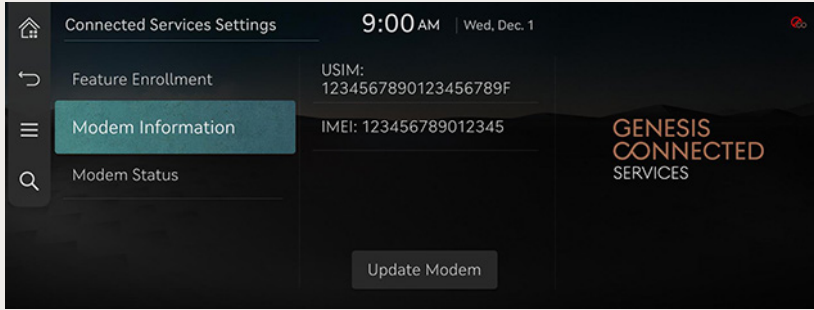



GENESIS CONNECTED SERVICES FEATURES

SAFETY

Automatic collision notification and assistance

Provides immediate assistance when an accident occurs and an airbag is deployed.

In this event, an ACN signal, containing customer and location information, will automatically be transmitted to the response center.

Upon receipt of the signal, a response specialist will attempt to establish voice communications with the vehicle occupants and forward any pertinent information to connected services emergency services.

SOS emergency assistance

Customers request emergency connected services emergency services by pressing the dedicated [SOS] button in the vehicle.

This action transmits vehicle information and location to specially trained response specialists, who assist in coordinating the dispatch of appropriate emergency assistance to the customer.

The response specialist remains on the line with the customer until advised assistance has arrived.

Roadside assistance (in Canada)

With the single press of a button, drivers can contact roadside assistance and their vehicle information and location are automatically transmitted to a response center for quicker, more efficient assistance.



CAR CARE

Monthly vehicle health report

You can begin receiving a comprehensive diagnostic evaluation involving most aspects of your vehicle's performance.

Automatic diagnostics trouble code notification

When owners receive a vehicle trouble code notification, this feature provides an explanation. Through a combination of in-vehicle display alerts and guided voice messages, the owner will learn what to do next.

Maintenance alert

This feature helps you keep your vehicle in optimum running order by notifying you in advance of regularly scheduled maintenance intervals.

Notification is made via your choice of text messaging or email.



REMOTE SERVICE

Remote door lock/unlock

With this feature, you can lock or unlock your vehicle doors from virtually anywhere by using the Genesis connected services mobile apps, or using the Genesis connected services owner's website.

Remote horn/lights

When the parking Spot in the parking lot of a hotel or mart is forgotten, the spot can be checked by the bilking lights and the horn sound.

Remote start with climate control

This feature enables you to remotely start your vehicle and set an engine timer from virtually anywhere.

You can also set the climate control temperature and turn on the front-window defroster, ensuring a warm or cool car is ready to go when you are.

Car finder

The mobile app feature enables you to find your vehicle on a map.

Remote 360 view

This function allows the user to find the current position of the vehicle and check the image around the vehicle via the smartphone.



VEHICLE SAFEGUARD

Stolen vehicle recovery

In the event a customer's vehicle is reported stolen (and a stolen vehicle report has been filed with the appropriate police department), the response center can provide assistance to the police in an attempt to recover the vehicle.

Vehicle immobilization

Used with stolen vehicle recovery, this enables law enforcement to send a signal to the vehicle which immobilizes the engine management system, thus preventing startup.

This capability is only valid when the ignition is off, but can be saved for later immobilization if the vehicle is on or in motion at the time of signal transmission.

Panic notification

This feature will notify any pre-selected persons of your vehicle's precise location if your vehicle's remote panic button is engaged, via your choice of text messaging or email.



Alarm notification

In the event your vehicle's alarm is activated, this feature will automatically notify any pre-selected persons via your choice of text messaging or email.

Valet alert

Whenever you leave your vehicle with a valet and it travels farther than your pre-selected distance boundary after activation, you will be notified in-vehicle and via your choice of text message or email.

Geo fence alert

This feature allows you to designate the boundaries of areas in which your vehicle may and may not be driven.

Should the vehicle cross these boundaries, you will be notified in-vehicle and via your choice of text messaging or email.

Speed alert

This feature allows you to pre-set a speed limit for your vehicle.

Should the speed limit be exceeded, you will be notified in-vehicle and via your choice of text messaging or email.

Curfew alert

This feature allows you to pre-set acceptable time intervals for when your vehicle can and cannot be driven.

Should these be exceeded, you will be notified in-vehicle and via your choice of text messaging or email.

DATA SERVICES



DATA SERVICES

HD Radio™ data service provides a variety of information. (Traffic, doppler radar, etc.)

1. Press [HD Radio Data] on the home screen.

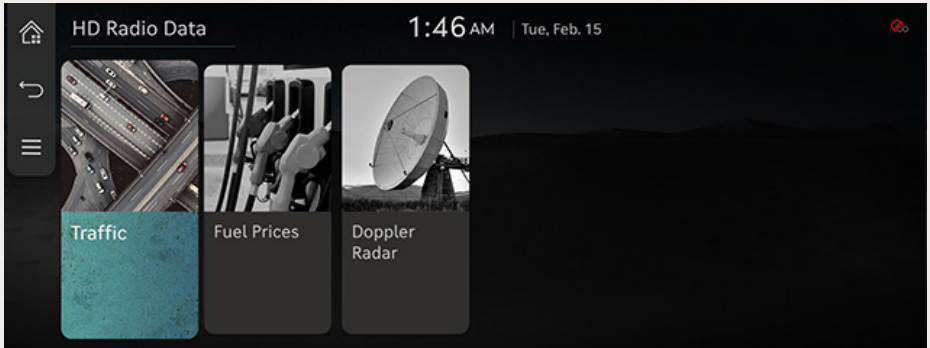

2. Select a desired information.
 - [Traffic]: Shows traffic information.
 - [Fuel Prices]: Shows fuel price information.
 - [Doppler Radar]: Shows Doppler radar weather information.

TRAFFIC INFORMATION

Check the current traffic condition or accident information.

1. Press [HD Radio Data] > [Traffic] on the home screen.

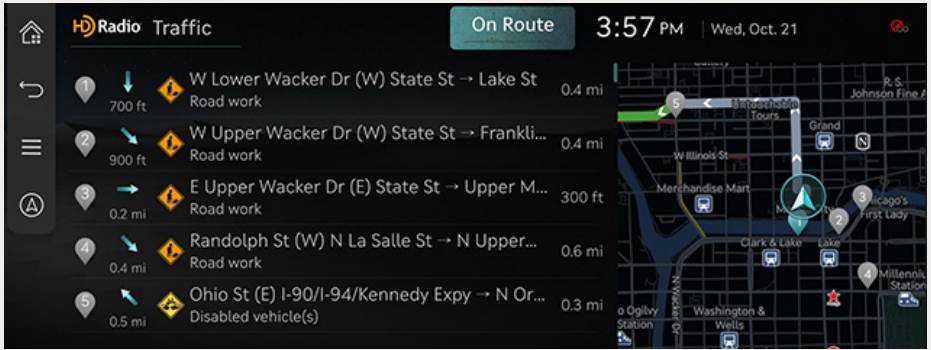

2. Press the desired information to check in detail..

! NOTE

This function may not be reflected depending on condition.

FUEL PRICES

1. Press [HD Radio Data] > [Fuel Prices] on the home screen.

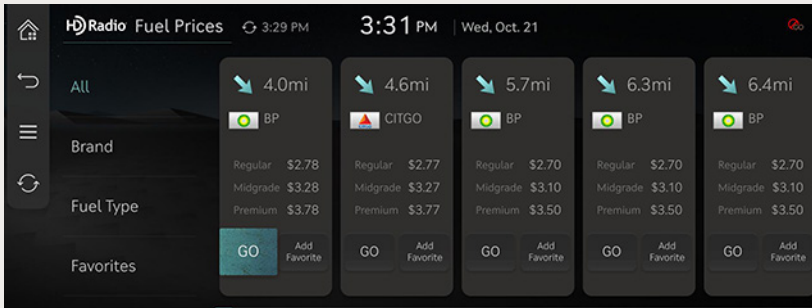

2. Press the desired item to view detailed information.

DOPPLER RADAR

When the vehicle is within an area that can receive HD Radio™ signals, it provides Doppler radar information for that area.

Press [HD Radio Data] > [Doppler Radar] on the home screen.

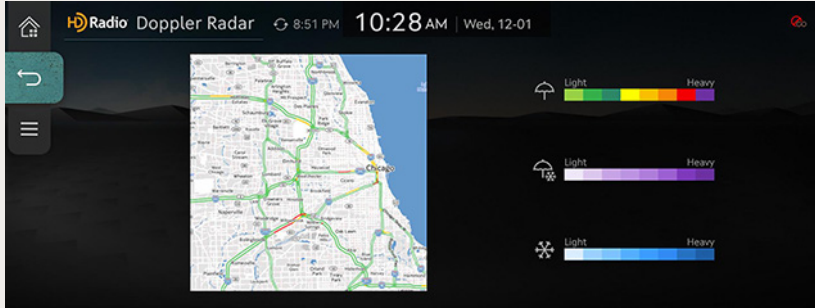

DRIVER ASSISTANCE



DRIVER ASSISTANCE

1. On the vehicle settings screen, press [Driver Assistance].

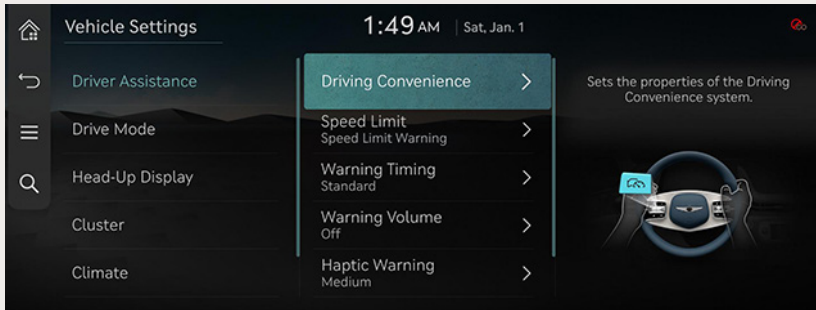

2. Press the desired item.

Driving Convenience

You can set the properties of driving assistance systems.

- [Smart Cruise Control]: Sets the properties of the smart cruise control system.
- [Highway Driving Assist]: Assists driving on a highway according to the set speed and distance while keeping the vehicle centered in the lane.

videopage025

- [Highway Lane Change Assist]: Automatically assists with lane changes on a highway when operating the turn signal switch.
- [Highway Auto Speed Change]: Automatically adjusts the vehicle speed on a highway based on navigation data.

Speed Limit

You can set the properties of the speed limit system.

- [Speed Limit Offset]: Adjusts the offset of the speed limit.
- [Auto Speed Change]: Auto-adjusts vehicle speed based on the posted speed limit.
- [Speed Limit Assist]: Adjusts the vehicle speed based on the current speed limit of the road.
- [Speed Limit Warning]: Displays the current speed limit of the road.
- [Off]: Disables the function.

Warning Timing

Sets the timing of the warning.

Warning Volume

Sets the volume of the warning sound.

Haptic Warning

Sets the intensity of the steering wheel vibration warning.

Driver Attention Warning

You can set the properties of driver attention warning system.

- [Leading Vehicle Departure Alert]: Alerts the driver during a stop, when the leading vehicle departs.
- [Forward Attention Warning]: Provides a warning when the driver is not looking forward.
- [Inattentive Driving Warning]: Warning of driver inattentiveness and recommendation of a rest if needed.

Forward Safety

You can set the properties of forward safety system.

- [Forward Cross-Traffic Safety]: Provides a warning and emergency braking when a risk of forward cross-traffic collision is detected.
- [Active Assist]: Provides a warning and vehicle control when a risk of forward collision is detected.
- [Warning Only]: Provides a warning when a risk of forward collision is detected.
- [Off]: Disables the function.

Lane Safety

You can set the properties of lane safety systems.

- [Assist]: Automatically assists with steering to help prevent the vehicle from leaving the lane.
- [Warning Only]: Provides a warning when the vehicle leaves the lane without operating the turn signal switch.
- [Off]: Disables the function.

Blind-Spot Safety

You can set the properties of blind-spot safety system.

- [Blind-Spot View Monitor] (If equipped): Displays the blind spot view in the cluster when operating the turn signal control.
- [Safe Exit Assist]: Provides a warning and door control when an approaching vehicle is detected in the vehicle's blind spot.
- [Safe Exit Warning]: Provides a warning when an approaching vehicle is detected in the vehicle's blind spot.
- [Active assist]: Provides a warning and vehicle control when a risk of blind-spot collision is detected.
- [Warning only]: Provides a warning when a risk of blind-spot collision is detected.
- [Off]: Disables Blind-Spot Safety functions.

Parking Safety

videopage006

videopage007

You can set the properties of parking safety system.

- [Camera Settings]: Sets the properties of camera.
- [Surround View Monitor Auto On] (If equipped): Automatically activates surround view monitor when parking distance warning activates.
- [Parking Distance Warning Auto On]: Automatically activates parking distance warning when driving at low speeds.
- [Front/Side Safety]: Provides a warning and emergency braking when a risk of forward or side collision is detected.
- [Rear Safety]: Provides a warning and emergency braking when a risk of rear collision is detected while reversing.
- [Rear Active Assist]: Provides a warning and emergency braking when a risk of rear collision is detected while reversing.

videopage027

- [Rear Warning Only]: Provides a warning when a risk of rear collision is detected while reversing.
- [Off]: Disables the function.
- [Rear Cross-Traffic Safety]: Provides a warning and emergency braking when a risk of rear cross-traffic collision is detected while reversing.

Snow Chains Installed

Select 'snow chains installed' to protect the vehicle by deactivating the rear wheel steering system.

MEDIA



PLAYING USB

PLAYING USB MUSIC

Connect a USB memory to USB connection terminal.

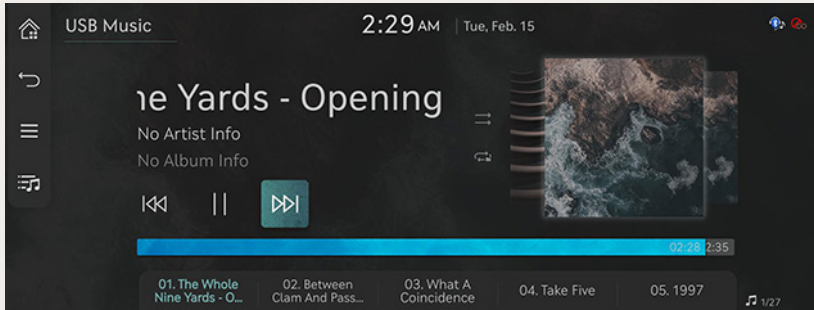

! NOTE

To play the connected USB music while other media is playing, press the [≡] > [Media Sources] > [USB Music] on the others media screen.

PAUSE/PLAY MUSIC

Pause or plays the file.

Location	Details
Screen	<ul style="list-style-type: none"> • Touch [⏸] during play. • Touch [▶] during pause.
Controller	<ul style="list-style-type: none"> • Press controller during play. • Press controller during pause.

PLAY PREVIOUS/NEXT MUSIC

Plays the previous or next music.

Location	Details
Screen	Touch [⏮▶▶].

FORWARD/REVERSE SEARCH MUSIC

Rapidly searches the music in play.

Location	Details
Screen	After touching on [] for a long time and release the finger at the desired spot, the music starts from that spot.

NOTE

- When pressing [] for 5 seconds or longer, the play speed changes as 4X > 20X.
- No audio is on during forward/reverse searching.

SEARCH PREVIOUS/NEXT MUSIC

Searches for the previous or next music.

Location	Details
Front seat control key	Rotate [TUNE] to up/down. And when the desired music is displayed press the button.
Controller	Rotate controller to left/right, and when the desired music is displayed press controller.

VIEWING LIST

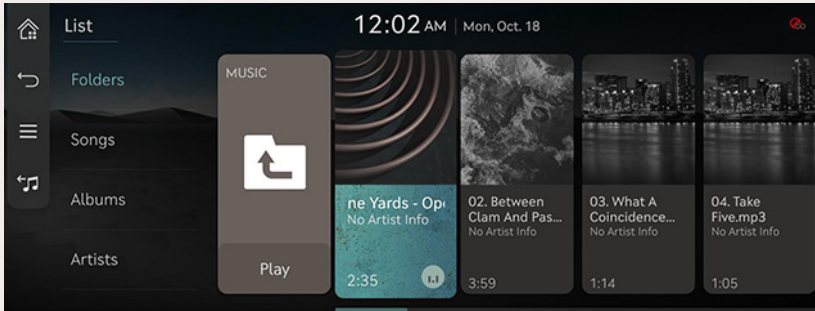

Plays the desired music by searching the list.

1. Press  on the play screen, Or press  > [List].



2. On the list screen, search for the desired music by category. (Folders, songs, albums, or artists)
3. Select the desired music, the music will play.

NOTE

- Press  to move to the upper level folder.
- If you press [Play] on the list screen, plays from the first song within the selected folder.
- To play repeatedly including the contents of a subfolder, press  > [Repeat All in Folder].

SHUFFLE

Plays the entire music randomly.

1. Press  > [Shuffle] on the play screen.

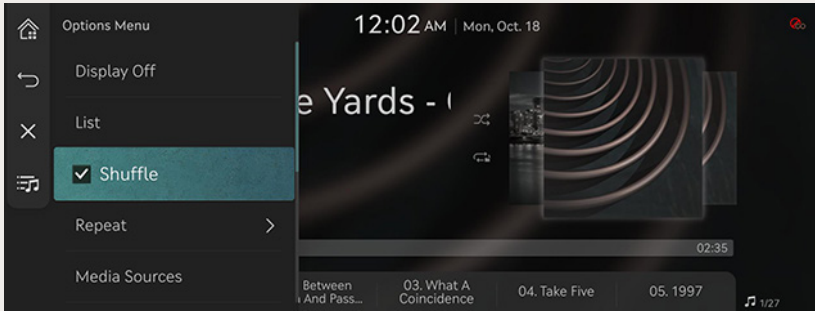

2. Check on the box left to [Shuffle] to set random play. To cancel the random play, press [Shuffle] again.

NOTE

Press  on the screen to enable/disable the shuffle play.



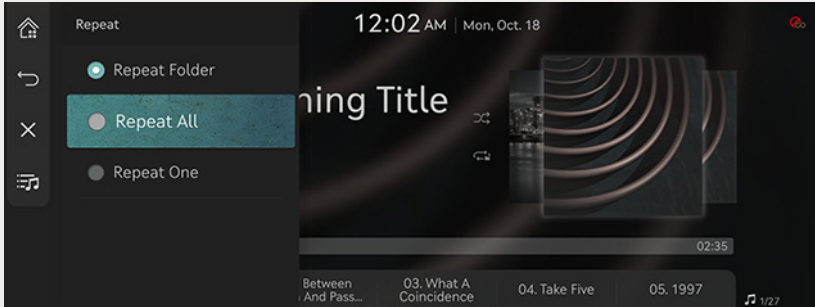

REPEAT





1. Press  > [Repeat] on the play screen.



2. Press a desired repeat mode.
 - [Repeat Folder]: Plays all music in the current folder repeatedly.
 - [Repeat All]: Plays the entire music repeatedly.
 - [Repeat One]: The currently playing music is played repeatedly.
 - [Repeat Album]/[Repeat Artist]: When playing in the album or artist category, all music in the category are played repeatedly.

NOTE

Press /[]/[]/[] on the playing screen to activate repeat.

- : Repeat all
- : Repeat album/repeat artist. (It is displayed when all files repeat during playback from the [Albums] or [Artists] category)
- : Repeat folder
- : Repeat one

SONGS FOR THIS ARTIST

Moves the artist list of the current song.

Press  > [Songs for This Artist] on the play screen.

NOTE

You can go to the list by pressing artist on the playing screen.

SONGS FOR THIS ALBUM

Moves the album list of the current song.

Press  > [Songs for This Album] on the play screen.

NOTE

You can go to the list by pressing album art on the playing screen.

HIDE CURRENT FILE

Moves the music currently in play to hidden_folder.

The move music is not shown in playlist and not available for play.

Press  > [Hide Current File] on the play screen.

SOUND SETTINGS

1. Press  > [Sound Settings] on the play screen.
2. For more details, refer to the "Sound settings".

PLAYING USB VIDEO

Connect a USB memory to USB connection terminal.

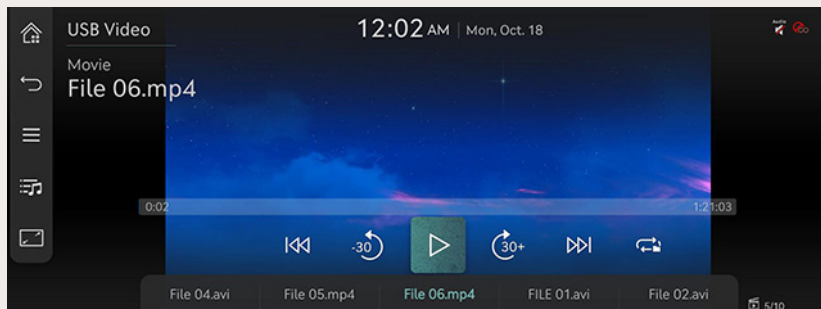



! NOTE

- To play USB video while the other media is in play, press  > [Media Sources] > [USB Video] on the others media screen.
- For the safety, the video is not supported and other partial features are restricted while the vehicle is in driving condition. However, the audio is played.
- Even when the vehicle stops, if the gear is not in "P" position, the video is not supported.

PAUSE/PLAY FILE

Pauses or plays the file.

Location	Details
Screen	<ul style="list-style-type: none"> • Touch  during play. • Touch  during pause.
Controller	<ul style="list-style-type: none"> • Press controller during play. • Press controller during pause.

FULL SCREEN MODE

Location	Details
Screen	<ul style="list-style-type: none"> • Touch the screen, • Touch [].
Controller	When controller is dragged to up or down or pressed on the entire screen, basic mode screen opens.

NOTE

When no control within 5 seconds on basic mode screen, it automatically switches to the entire screen.

PLAY PREVIOUS/NEXT FILE

Plays the previous or next file.

Location	Details
Screen	Touch [].

FORWARD/REVERSE SEARCH FILE

Rapidly searches the file in play.

Location	Details
Screen	After touching on [] for a long time and release the finger at the desired spot, the file starts from that spot.

NOTE

- When pressing [] for 5 seconds or longer, the play speed changes as 4X > 20X.
- No sound is on during forward/reverse searching.



SEARCHING PREVIOUS/NEXT FILE

Searches for the previous or next file.

Location	Details
Front seat control key	Rotate [TUNE] to up/down. And when the desired file is displayed press the button.
Controller	Swipe the touch pad left or right to select the desired file.



MOVE BEFORE/AFTER 30 SECONDS

Moves the playing file 30 seconds before/after.

Location	Details
Screen	Press [-30] / [(30*)].

VIEWING LIST

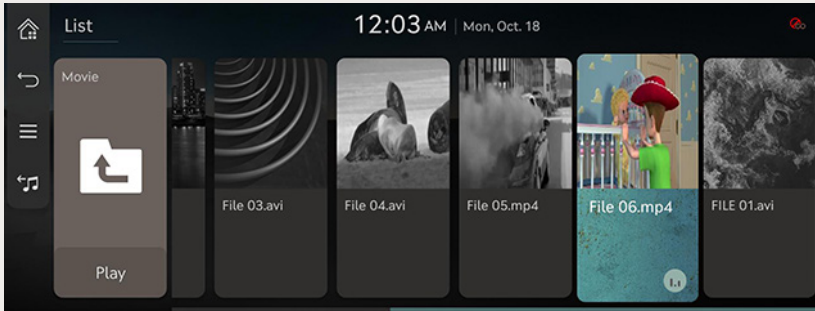

Plays the desired file by searching the list.

1. Press  on the play screen, Or press  > [List].



2. Select the desired file, the file will play.

NOTE

- Press  to move to the upper level folder.
- If you press [Play] on the list screen, plays from the first file within the selected folder.
- To play repeatedly including the contents of a subfolder, press  > [Repeat All in Folder].

REPEAT

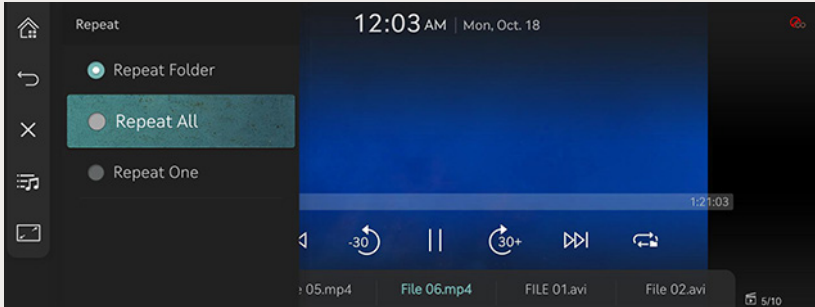

1. Press  > [Repeat] on the play screen.



2. Press a desired repeat mode.
 - [Repeat Folder]: Plays the entire file repeatedly.
 - [Repeat All]: Plays all file in the current folder repeatedly.
 - [Repeat One]: The currently playing file is played repeatedly.

NOTE

Press // on the playing screen to activate repeat.

- : Repeat all
- : Repeat folder
- : Repeat one



FILE INFORMATION

Checks the information of the file.

Press  > [File Information] on the play screen.

SUBTITLE SETTINGS

Available to use for a file supporting multiple-subtitles.

Selects the subtitle displayed on the screen.

1. Press  > [Subtitle Settings] on the play screen.
2. Select the desired option.

VOICE SETTINGS

Available to use for a file supporting multiple voice.

1. Press  > [Voice Settings] on the play screen.
2. Select a desired voice.

SOUND SETTINGS

1. Press  > [Sound Settings] on the play screen.
2. For more details, refer to the "Sound settings".

DISPLAY SETTINGS

Adjusts brightness/contrast/saturation for video play.

1. Press  > [Display Settings] on the play screen.
2. For more details, refer to the "Display settings".

PLAYING BLUETOOTH AUDIO

ACTIVATING BLUETOOTH AUDIO MODE

- Music saved in the mobile phone can be played in the car through Bluetooth audio streaming.
- Bluetooth audio can be played only when a Bluetooth phone has been connected.
- To play Bluetooth audio, connect the Bluetooth phone to the car system.
- For more information on connecting Bluetooth, please refer to the Pairing and connecting the unit and a Bluetooth phone.
- The audio streaming function may not be supported in some mobile phones.

1. Press [Media] > [Bluetooth audio] on the home screen.

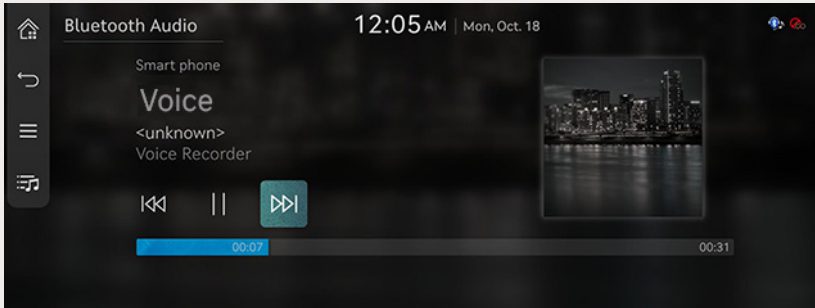

2. Plays the last music previously played.

! NOTE

- When Bluetooth audio is connected, Bluetooth audio menu is activated.
- To play the connected Bluetooth audio while other media is playing, press  > [Media Sources] > [Bluetooth Audio] on the others media screen.



PAUSE/PLAY MUSIC

Location	Details
Screen	<ul style="list-style-type: none"> • Touch [⏸] during play. • Touch [▶] during pause.
Controller	<ul style="list-style-type: none"> • Press controller during play. • Press controller during pause.

NOTE

Some mobile phone models may not support this feature.

PLAY PREVIOUS/NEXT MUSIC

Plays the previous or next music.

Location	Details
Screen	Touch [⏮/⏭].

NOTE

Some mobile phone models may not support this feature.

CHANGE DEVICE

You can connect the head unit and another Bluetooth device already paired.

Press  > [Change Device].

NOTE

You can use the change device function by pressing  on the playing screen.

SOUND SETTINGS

1. Press  > [Sound Settings] on the play screen.
2. For more details, refer to the "Sound settings".

PLAYING SOUNDS OF NATURE

ACTIVATING SOUNDS OF NATURE MODE

You can play the sounds of nature offered by the system.

1. Press [Media] > [Sounds of Nature] on the home screen.

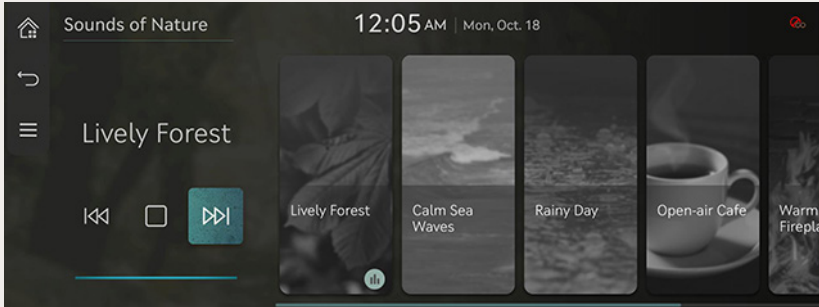

2. Press a desired sound.

! NOTE

To play the sounds of nature while other media is playing, press  > [Media Sources] > [Sounds of Nature] on the others media screen.

SOUND SETTINGS

1. Press  > [Sound Settings] on the play screen.
2. For more details, refer to the "Sound settings".

PLAYING PHONE PROJECTION

ACTIVATING PHONE PROJECTION MODE

1. To connect your mobile phone to the USB port, use a genuine Apple USB cable for Apple CarPlay, and use a standard USB cable for Android Auto.
2. Select [Android Auto] or [Apple CarPlay] on the home screen.
3. You can use the phone projection function.

NOTE

- Before connecting your mobile phone, make sure that the connection settings for [Use Phone Projection when Connecting to USB] is checked on the phone projection settings.
- To use Android Auto or Apple CarPlay after connecting your mobile phone, please unlock it.
- You may need to agree to use Android Auto or Apple CarPlay, depending on the type of the mobile phone you use.
- The screens and features displayed in the infotainment system can be changed according to the policy of each company.

Cautions - Android Auto

- Bluetooth media features will be disabled when Android Auto is activated.
- After removing the USB cable, these features will be available again.
- If Android Auto is not activated even after a successful connection, follow these steps:
 - Check whether an error occurred on the phone.
 - Check whether Android Auto has been closed on the phone.
 - Check whether Android Auto is activated in the phone projection settings.
- If Android Auto does not work normally even after a reconnection has been made, visit the Google website. (<http://support.google.com/androidauto/>)
- Please refer to the following websites to check the available countries for the Android Auto. (<https://www.android.com/auto>)



Cautions- Apple CarPlay

- Bluetooth phone/media features will be disabled when Apple CarPlay is activated.
- After removing the USB cable, these features will be available again.
- If Apple CarPlay is not activated even after a successful connection, follow these steps:
 - Check whether Apple CarPlay is disabled in the iPhone's application settings.
 - Check whether Apple CarPlay is activated in the phone projection settings.
- If Apple CarPlay does not work normally even after a reconnection has been made, visit the Apple website. (<http://www.apple.com/ios/carplay/>)
- Please refer to the following websites to check the available countries for the Apple CarPlay. (<http://www.apple.com/ios/feature-availability/>)

RADIO



LISTENING TO RADIO

ACTIVATING RADIO MODE

1. Press the [RADIO] button on the head unit. Or press [Radio] on the home screen.

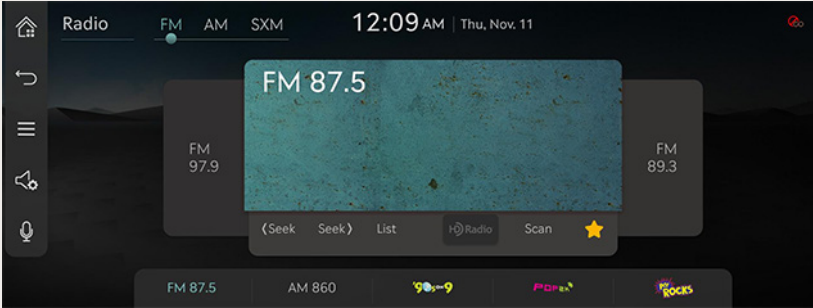

2. The last listened mode among FM, AM or SiriusXM plays.

! NOTE

- Press the [RADIO] button on the head unit to change to the desired mode.
- Each time the [RADIO] button on the head unit is pressed, the radio mode is switched.

SELECTING THE RADIO STATION

MANUALLY SELECTING A RADIO STATION

Turns the [TUNE] button on the front seat control key to select a radio station.

AUTOMATICALLY SELECTING A RADIO STATION

In FM/AM mode, press [Scan].

RADIO STATION PRESET LIST

Listening the radio is available by selecting a station saved in preset list.

In FM or AM mode, press the preset list where the desired station is saved or swipe the optical touch pad on steering wheel remote control to listen the desired station.



RADIO STATION FAVORITES

ADDING TO PRESETS

Adds the desired radio stations to the presets.

1. Press the desired radio mode.
2. Select a station desired to save.

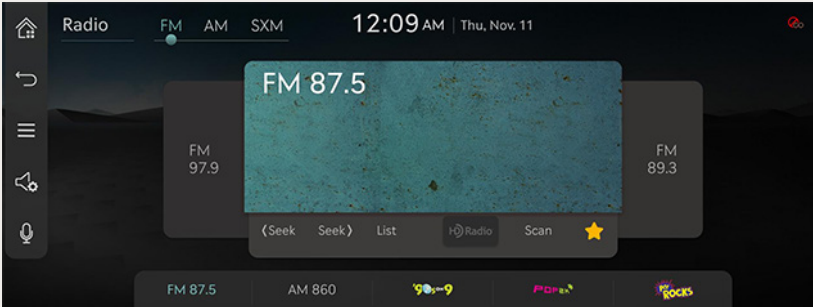

3. Press [☆].

DELETING THE PRESETS

1. Press the desired radio mode.
2. Press [≡] > [Delete Presets].

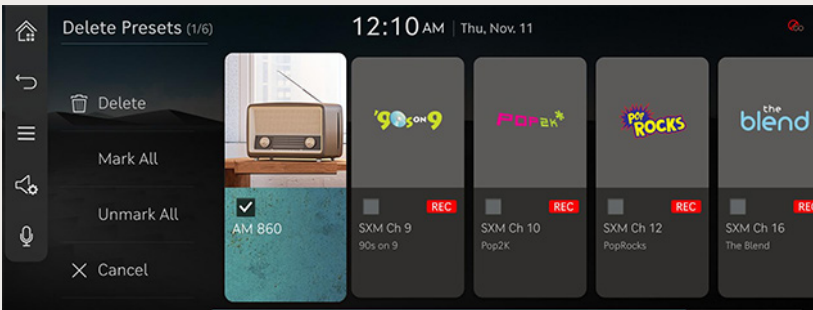

3. Select the desired item, press [Delete] > [Yes].

STATION LIST

Checks radio stations with good reception.

1. Press  > [Station List] on the screen.

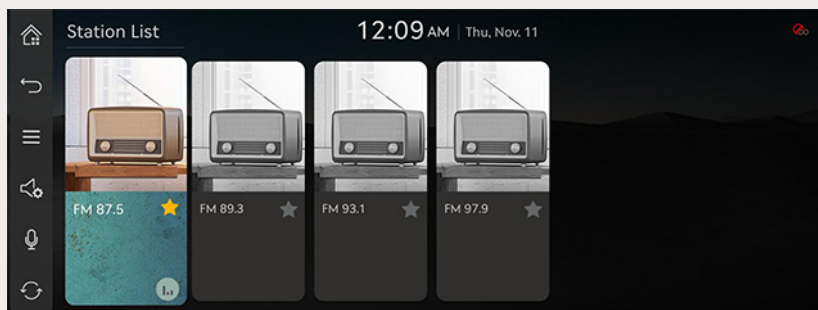

2. Press the desired broadcast station.

SCANNING RADIO STATIONS

All radio stations are scanned, and only radio stations with good reception are played every 5 seconds.

1. Press the desired radio mode.
2. Press [Scan].



NOTE

Pressing [Stop] during scanning cancels the scan and returns to the previous radio station.



SHOW RADIO TEXT

If current broadcast includes radio text information, the text information is displayed on the screen.

Press  > [Show Radio Text] in FM mode.

SOUND SETTINGS

1. Press  > [Sound Settings].
2. For more details, refer to the "Sound settings".

LISTENING TO HD RADIO™

The HD Radio™ screen is displayed only when a HD Radio™ broadcast is being received.

ACTIVATING HD RADIO™ MODE

1. Press the desired radio mode.

If an HD Radio™ broadcast is received, the radio mode will switch from analog broadcast to HD Radio™ broadcast.



2. Press  > [HD Radio].
3. The HD Radio™ will be off and switch to analog broadcast.

NOTE

- HD Radio™ reception is available when the vehicle is in radio mode.
- The ways of saving preset and searching for frequencies for standard radios are identical for HD Radio™.
- The HD Radio™ icon will be displayed when the vehicle is within regions where HD Radio™ signals can be received.
- The default setting of HD Radio™ is set to on.
- HD Radio™ technology is a digital radio technology used by FM and AM radio broadcast stations to transmit audio and data via a digital signal in conjunction with their analog signals.
- While listening to the radio, the HD Radio™ icon will become displayed if receiving an HD Radio™ broadcast.

LISTENING TO SIRIUSXM™ RADIO

ACTIVATING SIRIUSXM™ MODE

1. Press [RADIO] button on the head unit. Or press [Radio] on the home screen.
2. Press [SXM].

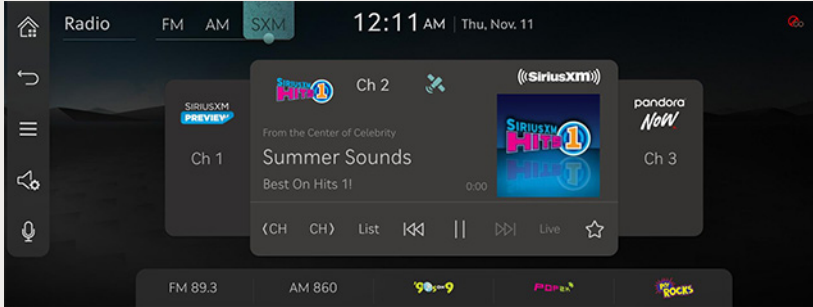

3. The SiriusXM radio screen of the most recent listened channel will be displayed.

SELECTING SIRIUSXM CHANNEL

MANUALLY SELECTING A CHANNEL

- On the SiriusXM radio screen, press [< CH] or [CH >] to select a channel.
- Turns the [TUNE] button on the front seat control key to select a channel.

SIRIUSXM CHANNEL FAVORITES

ADDING CHANNEL TO PRESETS

A total of 40 presets and channels including FM/AM/SiriusXM channels can be saved.

1. On the SiriusXM radio screen, select a channel.

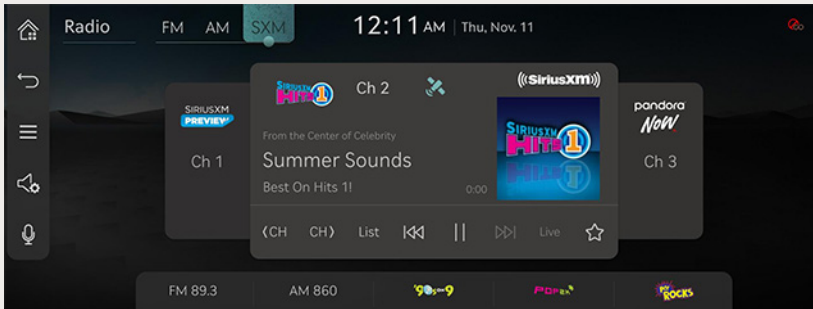

2. Press [☆].

DELETING CHANNEL FROM THE PRESETS

1. On the SiriusXM radio screen, press  > [Delete Presets].

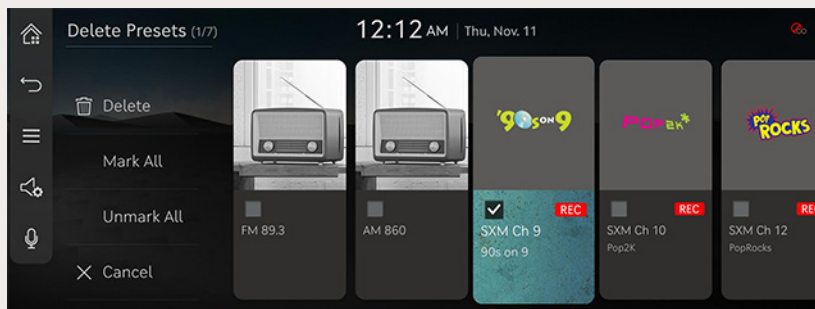

2. Select the desired item, press [Delete] > [Yes].

CATEGORY LIST

1. On the SiriusXM radio screen, press [List].

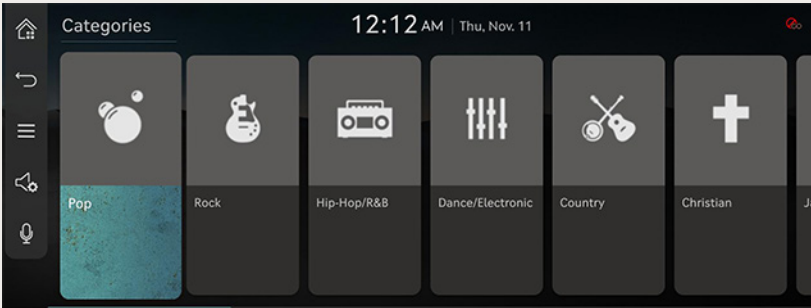

2. Press the desired item.

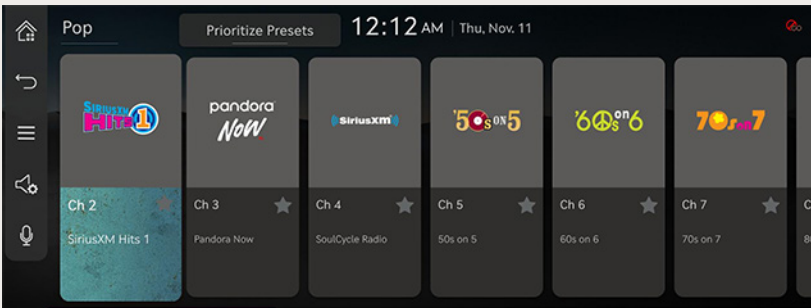

- [Prioritize Presets]: Displays the channels saved in the preset as priority.
- [☆]: Saves channels to the presets.

ENTER CHANNEL NUMBER

Enters a channel number to search for a channel.

1. On the SiriusXM radio screen, press [Enter Channel].

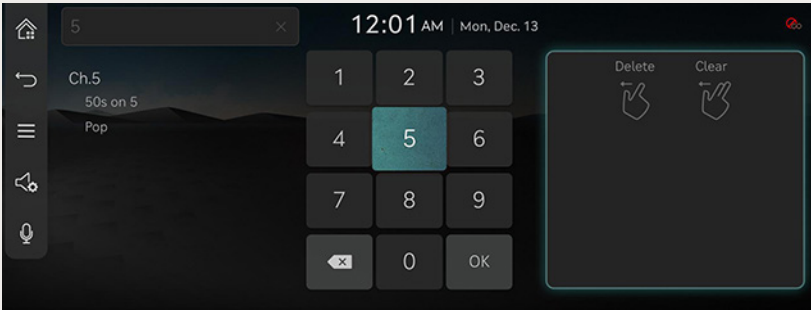

2. Enter the channel number.
3. The searched channel is received.

SUBSCRIPTION STATUS

Checks the subscription status of SiriusXM.

On the SiriusXM radio screen, press  > [Subscription Status].

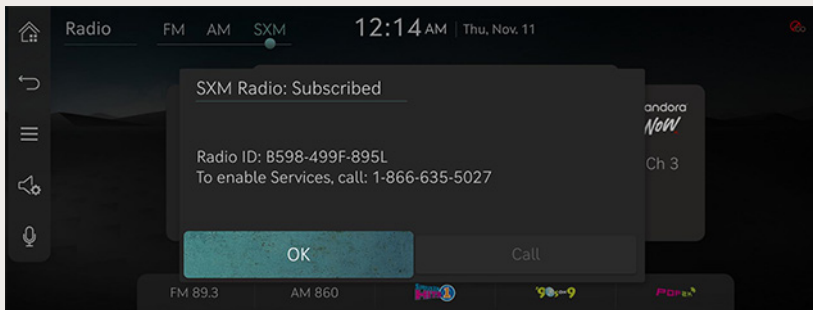

! NOTE

- If you have not subscribed to the SiriusXM service, press [Call] to enable services.
- It is available only when your phone is connected via Bluetooth.

PHONE



BLUETOOTH

BLUETOOTH WIRELESS TECHNOLOGY

WHAT IS BLUETOOTH WIRELESS TECHNOLOGY?

- Bluetooth wireless technology refers to a short-distance wireless networking technology which uses a 2.45GHz frequency to connect various devices within a certain distance.
- Supported within PCs, external devices, Bluetooth phones, PDAs, various electronic devices, and automotive environments, Bluetooth wireless technology to be transmitted without having to use a connector cable.
- Bluetooth hands-free refers to a device which allows the user to conveniently make phone calls with Bluetooth mobile phones through the system.
- The Bluetooth hands-free feature may not be supported in some mobile phones.

PRECAUTIONS FOR SAFE DRIVING

- Excessive use or operations while driving may lead to negligent driving practices and be the cause of accidents. Do not operate the device excessively while driving.
- Viewing the screen for prolonged periods of time is dangerous and may lead to accidents. When driving, view the screen only for short periods of time.



CAUTIONS UPON CONNECTING BLUETOOTH PHONE

- Before connecting the head unit with the mobile phone, check to see that the mobile phone supports Bluetooth features.
- If you do not want automatic connection with your Bluetooth device, turn the Bluetooth feature off of the Bluetooth device.
- Park the vehicle when pairing the head unit with the mobile phone.
- Some Bluetooth features may occasionally not operate properly depending on the firmware version of your mobile phone. If such features can be operated after receiving a S/W upgrade from your mobile phone manufacturer, Unpair all devices and pair again before use.
- When pairing and the head unit with the iPhone for the first time while your iPhone is connected to the USB port with iPhone cable, error message may be displayed on your iPhone. But, this is intended operation. You may ignore it if your iPhone has been connected to the head unit.

PAIRING AND CONNECTING THE UNIT AND A BLUETOOTH PHONE

To use the Bluetooth feature, make sure the Bluetooth on your phone is turned on. Refer to your phone's user guide.

WHEN NO PHONES HAVE BEEN PAIRED

1. Press [Phone] on the home screen. Or press the Bluetooth call button on the steering wheel remote control.

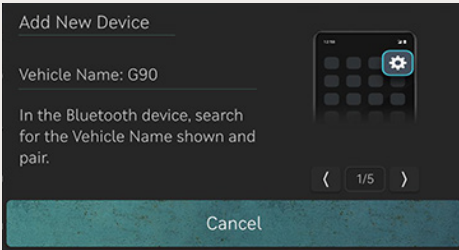

2. Search and select the vehicle name on Bluetooth device registration waiting screen.

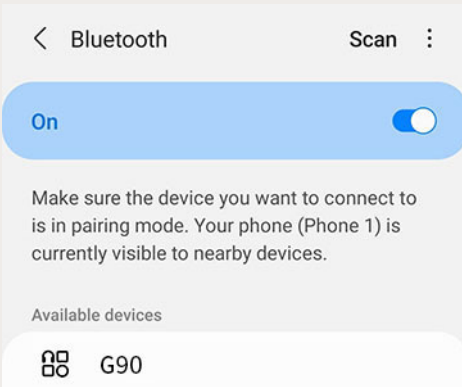

<Ex: Bluetooth device screen>

3. Checks the passkey and approve the registration on the Bluetooth device.

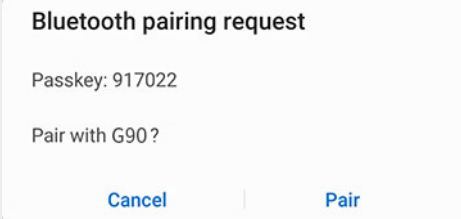

<Ex: Bluetooth device screen>

4. Requests permission to access your contacts and call history.

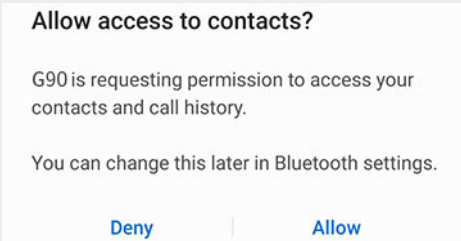

<Ex: Bluetooth device screen>

5. Requests permission to access your messages.

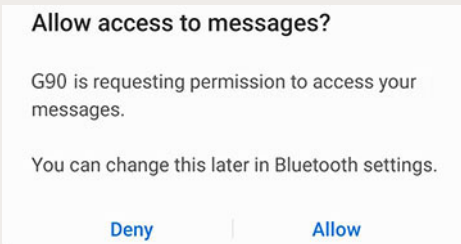

<Ex: Bluetooth device screen>

6. The Bluetooth device is connected.

NOTE

- The initial vehicle name is registered as purchased vehicle name.
- Depending on the Bluetooth device or Android, iOS phone, the message may appear differently.
- For iOS phones, set the Bluetooth notification.

WHEN A PHONE IS ALREADY PAIRED

1. Press [Setup] > [Device Connections] > [Device Connections] on the home screen.
Press the name of device to connect.
2. To add a new Bluetooth device, press [Add].
3. Search and select the vehicle name on Bluetooth device registration waiting screen.

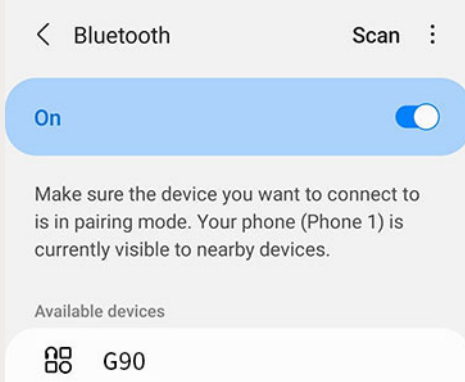

<Ex: Bluetooth device screen>

4. Checks the passkey and approve the registration on the Bluetooth device.

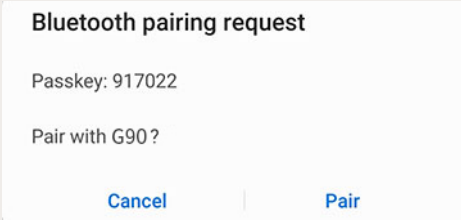

<Ex: Bluetooth device screen>

5. Requests permission to access your contacts and call history.

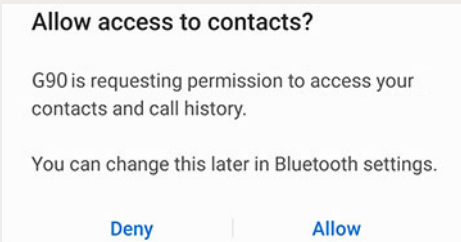

<Ex: Bluetooth device screen>

6. Requests permission to access your messages.

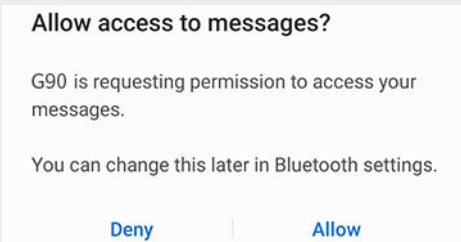

<Ex: Bluetooth device screen>

7. The Bluetooth device is connected.

 **NOTE**

- Up to 6 Bluetooth devices are allowed for the registration.
- One Bluetooth hands-free or two Bluetooth audio device are allowed.
- Only one Bluetooth device is allowed for each registration.
- No device can be registered while connecting a Bluetooth device.
- Only features related to Bluetooth Hands-free, the phonebook synchronization, the message synchronization and Bluetooth audio are supported.



CHANGE DEVICE

You can connect the head unit and another Bluetooth device already paired.
Press [Phone] >  > [Change Device] on the home screen.

NOTE

You can use the change device function by pressing  on the playing screen.

CANCELLING DEVICE CONNECTION

1. Press [Phone] >  > [Device Connections Settings] on the home screen.
2. Press  of the connected device. The Bluetooth hands-free connection is disconnected.

NOTE

Press  to disconnect the Bluetooth audio connection.

DELETING DEVICE

1. Press [Phone] > [☰] > [Device Connections Settings] on the home screen.
2. Press [Delete].

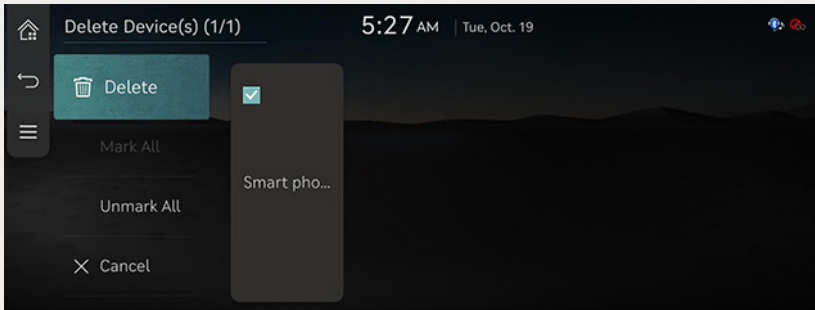

3. Select the desired item, press [Delete] > [Yes].

NOTE

When a device is deleted, the recent calls and the contacts of the device saved in the head unit are entirely deleted.

MAKING PHONE CALLS

MAKING PHONE CALLS BY ENTERING THE NUMBER

1. Press [Phone] > [☰] on the home screen.

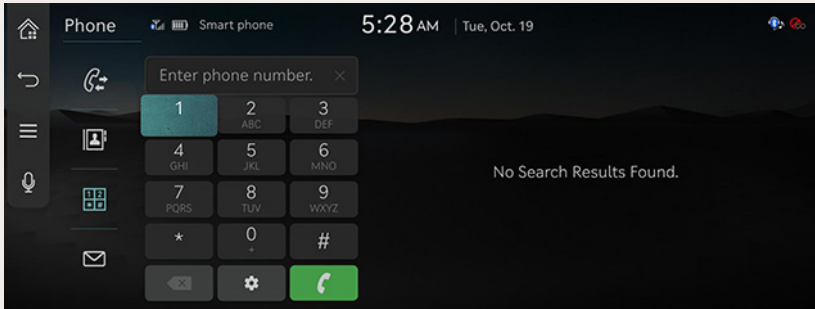

2. Enter the phone number.
3. Press [📞] on the screen.
Or press the Bluetooth call button on the steering wheel remote control.
4. Calls the entered phone number.

! NOTE

- In case of entering a wrong number, press [⬅️X] to delete each digit.
- Press and hold [⬅️X] delete all entered numbers.
- Press and hold the number [0], '+' is entered in the number input window.
- Phone call is available by entering only a part of the phone number.



MAKING PHONE CALLS VIA SPEED DIAL

1. Press [Phone] > [☰] on the home screen.
2. Press and hold the speed dial number registered in the phone.
 - Ex) If the speed dial number is 8 (one digit), press and hold '8'.
 - Ex) If the speed dial number is 12 (two digits), short press '1' and long press '2'.
3. Calls the speed dial number.

NOTE

Some mobile phone models may not support this feature.

MAKING PHONE CALLS VIA RE-DIAL

1. Press [Phone] > [☰] on the home screen.
2. Press and hold [📞] on the screen.
3. Calls the most recently dialed phone number.

! NOTE

- Re-dial is not available if no phone call has been made or a Bluetooth phone is not connected.
- Press [📞] shortly on the dial screen, the most recently dialed phone number is entered in the number input window.

RECEIVING PHONE CALLS

1. To receive an incoming call, press [Accept] on the screen.

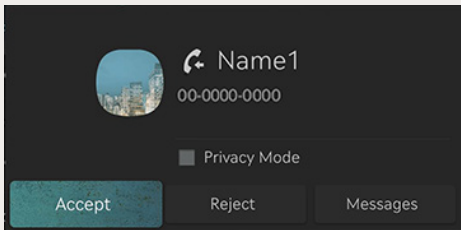

2. The call is connected.

REJECTING PHONE CALLS

1. To reject an incoming call, press [Reject] on the screen.

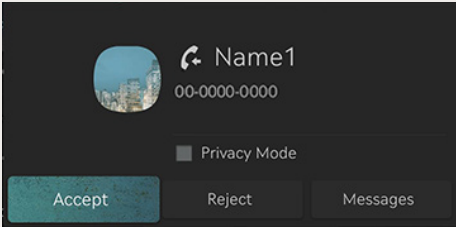

2. The call is rejected.

NOTE

Some mobile phone models may not support this feature.

RESPONDING TO INCOMING CALL WITH TEXT

1. Press [Messages] on the screen, respond to incoming calls by text message.

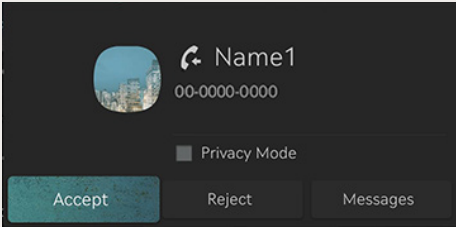

2. Select the desired message.

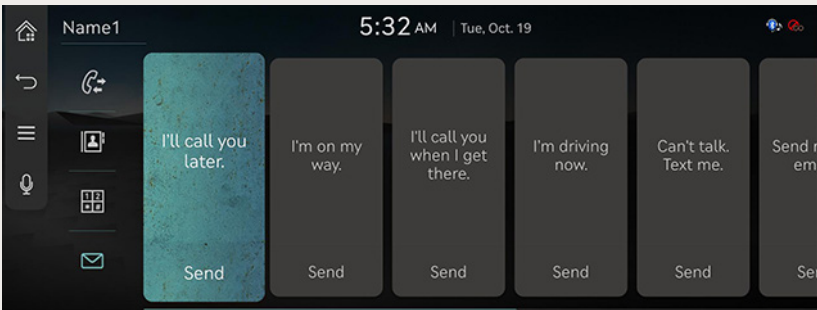

3. Press [Send].

NOTE

Some mobile phone models may not support this feature.

SWITCHING CALLS TO MOBILE PHONE/HANDS-FREE

Switches a call from hands-free to mobile phone or vice versa.

1. Press [Phone] on the home screen. The hands-free mode is displayed.

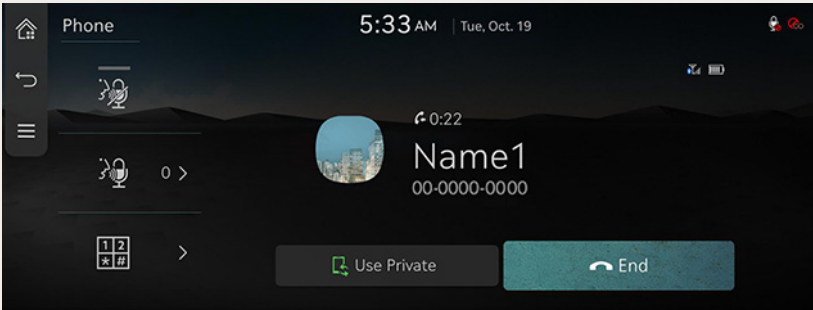

2. During a call, press [ Use Private].

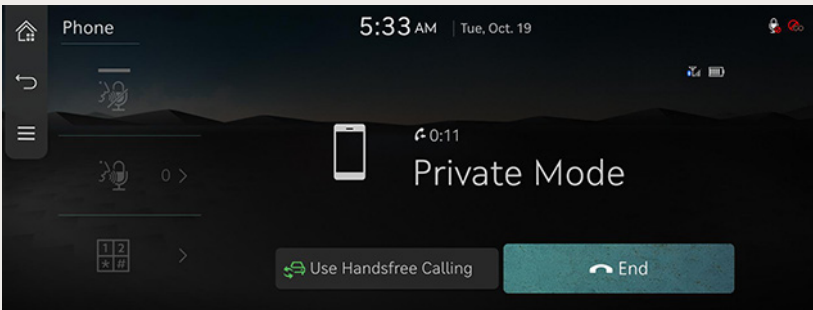

3. The private mode is displayed.

To switch to the hands-free mode, press [ Use HandsFree Calling] on the screen.

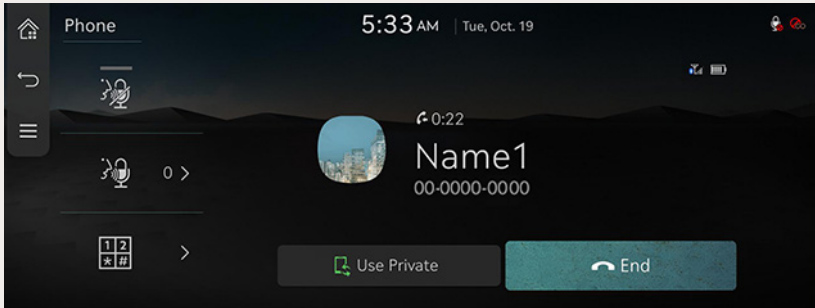

HANGING UP CALLS

1. Press [ End] on the screen during a call.



2. The call ends.

NOTE

- To cut the sound delivered to the other party during a phone conversation, press [.
- To control the mic volume during a phone conversation, press [.
- To open dial pad during a phone conversation, press [.

USING CALL HISTORY

DOWNLOADING CALL HISTORY

You can download the recent call history stored on your mobile phone to the system.

1. Press [Phone] >  on the home screen.

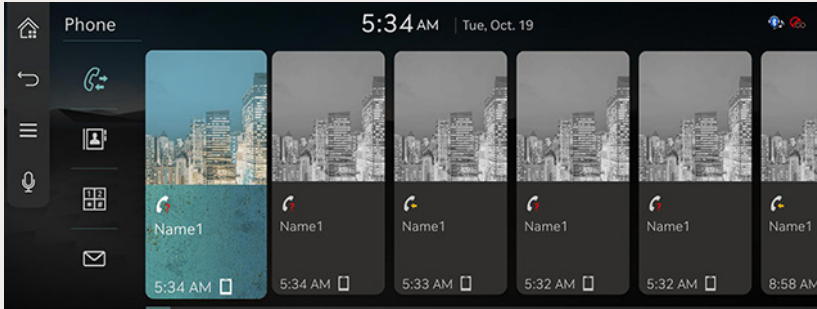

2. Press  > [Download] > [Yes].

NOTE

- The previous data is deleted when contacts of the mobile phone is downloaded.
- Some Bluetooth devices may not support this feature.

CALLING CALL HISTORY

1. Press [Phone] > [📞] on the home screen.

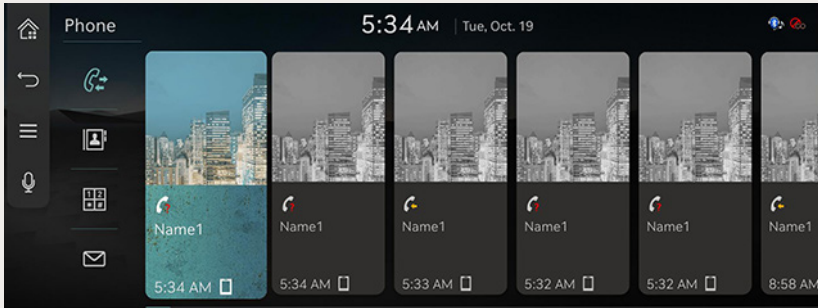

2. Select a contact to call.

! NOTE

- Call history may not be saved depending on the mobile phone model.
- If there is no recent call history or a Bluetooth device is not connected, the call history is not available.
- Up to 150 calls can be saved respectively in dialed-calls, received calls and missed calls.

USING CONTACTS

DOWNLOADING CONTACTS FROM THE MOBILE PHONE

Contacts record saved in the mobile phone can be downloaded into the system.

1. Press [Phone] >  on the home screen.

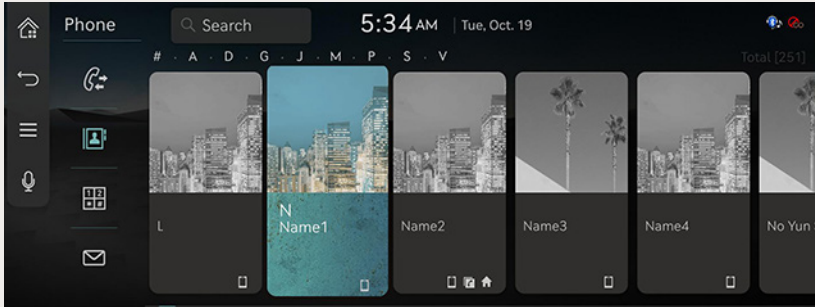

2. Press  > [Download] > [Yes].

NOTE

- The previous data is deleted when contacts of the mobile phone is downloaded.
- Some Bluetooth devices may not support this feature.

SEARCHING IN CONTACTS

1. Press [Phone] > [📞] on the home screen.
2. Press [☰] > [Search Contacts].

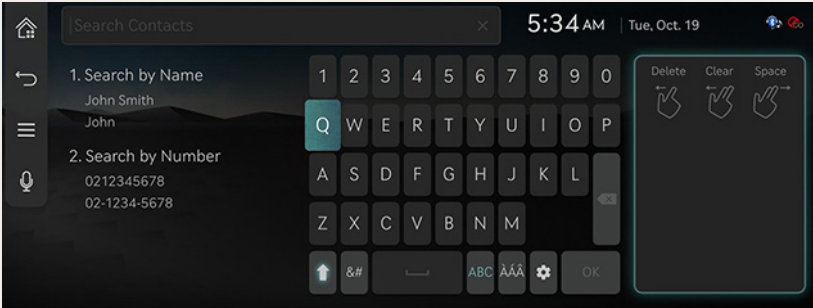

3. Search by name or phone number.

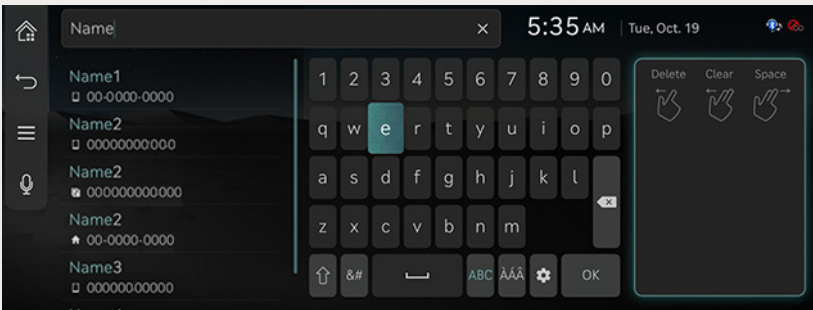

4. Press the searched contact to make a call.

USING DIAL SCREEN

Press [Phone] > [☰] on the home screen.

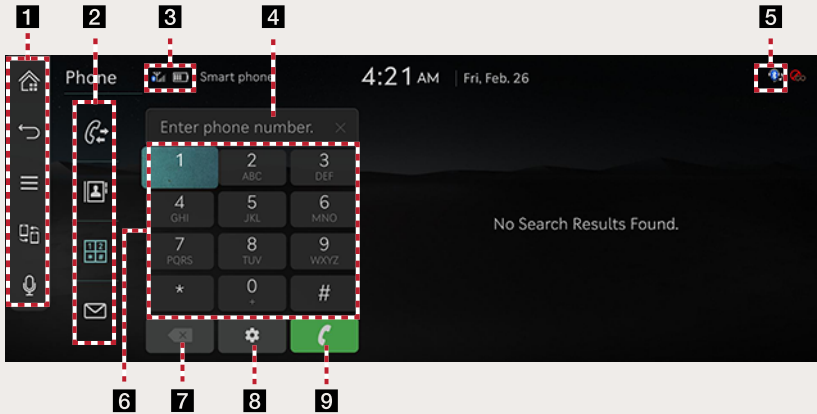

1

Moves to the home screen.



Moves to the home screen or the previous screen.



Displays pop-up menu of each mode.



Change to another connected device. (Displays the icon when there is more than one connected device.)



Moves to the voice recognition screen.

2 Call history (📞)

Moves to the call history screen.

Contacts (👤)

Moves to the contacts screen.

Dial (☎)

Moves to the dial screen.

Message (✉)

Moves to the message screen.

3 Reception level icon (📶)

The reception level (sensitivity) of the calling area is specified in the bar graph.

Mobile battery icon (🔋)

Specifies the remaining battery of mobile phone.

4 Number entrance window

Enter phone number or initial letter.

5 Bluetooth connection icon

Shows the connection status between Bluetooth phone and the head unit.

6 Keypad

Enter the phone number to call.

7 Delete (✖)

Deletes the entered phone number.

8 Settings (⚙)

Moves to Bluetooth settings screen.

9 Call (📞)

- If there is a registered phone number, the call is connected.
- If there is no registered phone number, the most recent call number is entered.

USING MESSAGE

CHECKING NEW MESSAGES

1. When a message is received, the pop-up is displayed on the screen.

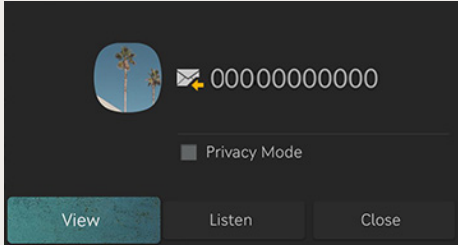

2. Select a desired item.
 - [View]: Moves to the message screen.
 - [Listen]: Listens to the message.
 - [Close]: Closes the pop-up.

NOTE

Activate the notification view setting in your phone's Bluetooth settings.

CHECKING MESSAGE INFORMATION

1. Press [Phone] > [✉] on the home screen.

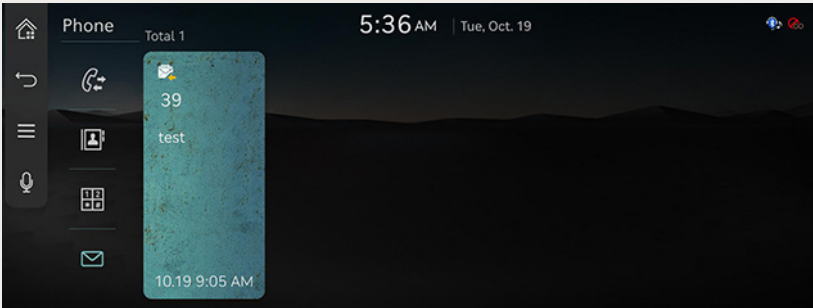

2. Select a message.

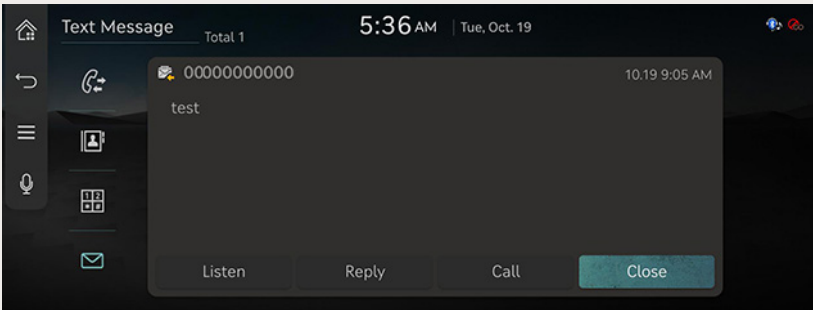

3. Check the information on message.

NOTE

- Only the messages received after the Bluetooth connection are specified in the list.
- Some Bluetooth devices may not support this feature.

SYSTEM



VEHICLE SETTINGS

The images displayed on this system may differ from actual ones.

Depending on the vehicle's options and the condition of the controller, some menus may not be displayed.

On the home screen, press [Setup] > [Vehicle].

The vehicle settings screen is displayed.

DRIVE MODE

1. On the vehicle settings screen, press [Drive Mode] .

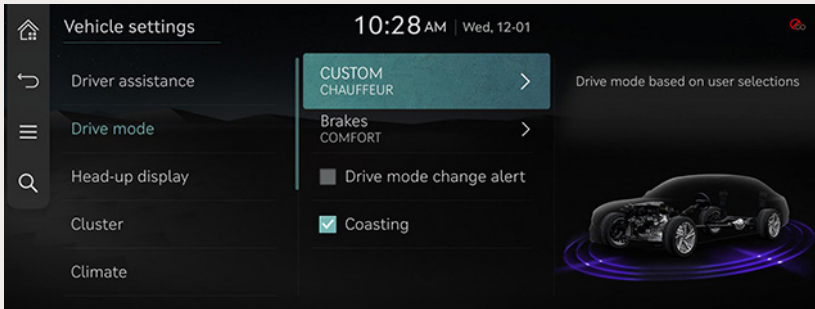

2. Press the desired item.

- [CUSTOM]: Sets a personalized custom drive mode based on user selections.
- [Brakes]: Sets the standard braking mode optimized for comfortable daily driving.
- [Drive Mode Change Alert]: Selects change information display method in case of drive mode change.
- [Coasting]: Decouples the engine from the transmission while coasting for better fuel economy in eco/smart drive modes.

ACTIVE SOUND DESIGN (IF EQUIPPED)

1. On the vehicle settings screen, press [Active Sound Design].

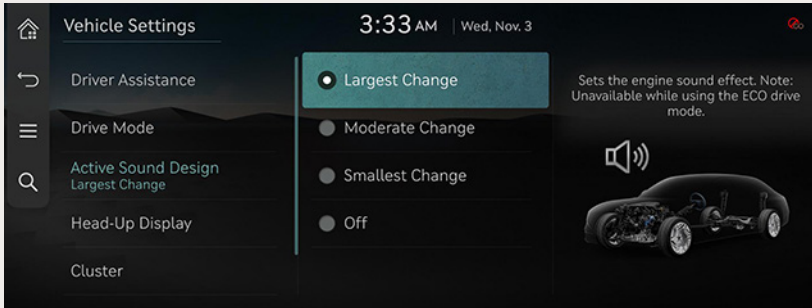

2. Press the desired items.
 - [Largest Change]/[Moderate Change]/[Smallest Change]/[Off]: Sets the engine sound effect, Note: Unavailable while using the ECO drive mode.

HEAD-UP DISPLAY

1. On the vehicle settings screen, press [Head-Up Display].

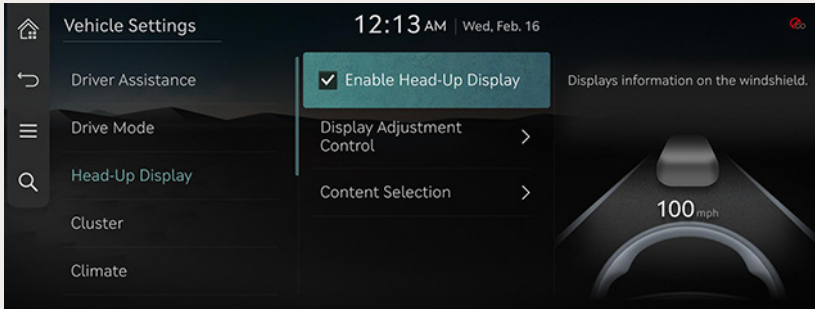

2. Press the desired item.

- [Enable Head-Up Display]: Sets to show the head-up display on the windshield is available.
- [Display Adjustment Control]: Controls the display height, rotation and brightness to desired values.
- [Content Selection]: Sets the information to display on the heads-up display.

CLUSTER

1. On the vehicle settings screen, press [Cluster].

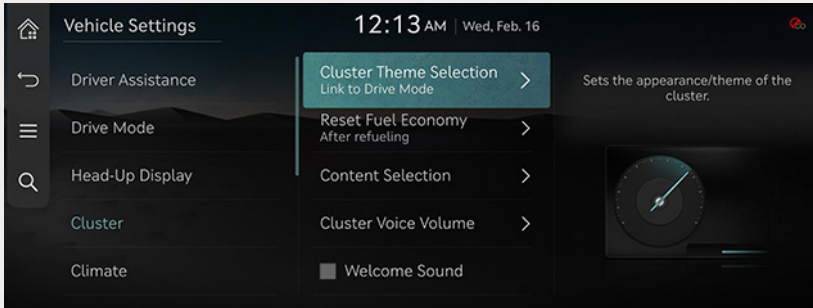

2. Press the desired item.
 - [Cluster Theme Selection]: Selects a cluster theme.
 - [Reset Fuel Economy]: Selects when to reset the average fuel economy display.
 - [Content Selection]: Selects information to display on cluster.
 - [Cluster Voice Volume]: Adjusts the cluster voice volume level.
 - [Welcome Sound]: Provides an audible tone when the cluster turns on or off.

NOTE

- An alarm in the vehicle, guidance sound and welcome sound are generated from external amplifier.
- If you replace the amplifier with a non-genuine part or replace the speakers with a non-genuine part, the amplifier may not work.
- Visibility may decrease if the user adjusts the screen brightness to dark in a bright environment.

CLIMATE

1. On the vehicle settings screen, press [Climate].



2. Press the desired item.
 - [Recirculate Air]: Blocks the flow of outside air into the vehicle cabin.
 - [Automatic Ventilation]: Switches the ventilation system to fresh air mode automatically after an extended use of recirculate air.
 - [Defog/Defrost Options]: Directs air to the windshield to reduce moisture on the windshield glass.
 - [Fragrance]: Selects the intensity and type of fragrance.
 - [Climate Features]: Activates the convenience functions for climate control.
 - [Warmer/Ventilation Features]: Sets the warmer/ventilation features.

SEAT

1. On the vehicle settings screen, press [Seat].

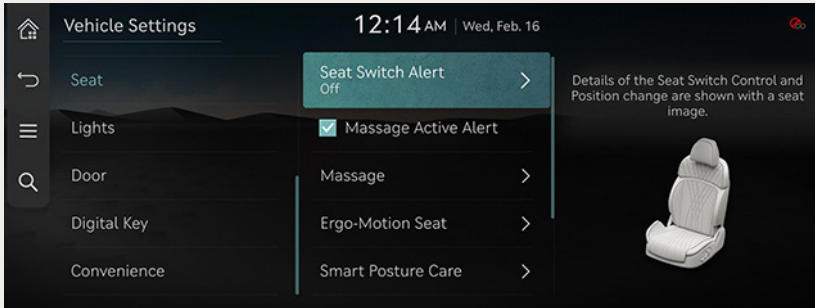

2. Press the desired item.
 - [Seat switch Alert]: When the seat position changes, details of the change are shown with a seat image.
 - [Message Active Alert]: When the message activates, operation information is shown with the seat image.
 - [Message]: Reduces fatigue and helps to improve the overall driving experience.
 - [Ergo-Motion Seat]: Reduces fatigue and helps to improve the overall driving experience.
 - [Smart Posture Care]: Recommends a posture fitting the driver's body type and provides a clinical analysis for back health.

videopage029

- [Warmer/Ventilation Features]: Sets the heated/ventilated features.
- [Seating Easy Access]: The seat/steering wheel are moved so the driver can more easily exit/enter the vehicle.

LIGHTS

1. On the vehicle settings screen, press [Lights].

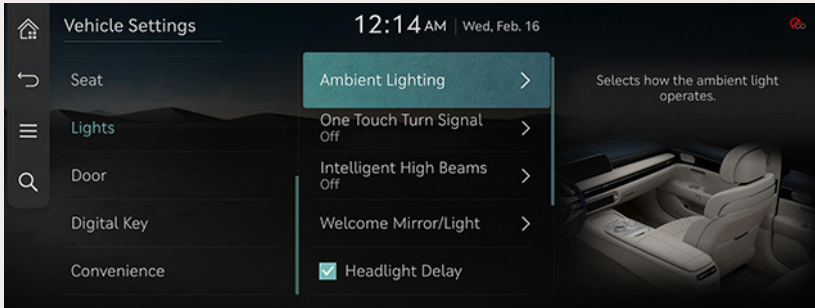

2. Press the desired item.
 - [Ambient Lighting]: Sets the interior mood lighting.
 - [One Touch Turn Signal]: Selects the number of blinks of turn signal by touching the turn signal lever.
 - [Intelligent High Beams]: Selects the vehicle speed at which the feature activates, or set to disable the feature.
 - [Welcome Mirror/Light]: The welcome feature is enabled
 - [Headlight Delay]: When the ignition is turned off, the exterior lights turn off after approximately 15 seconds.
 - [High Beam Assist]: Assists in reducing the high beam glare which affects drivers in oncoming vehicles.
 - [Dynamic Welcome Light]: Selects the mode of the dynamic welcome light.

DOOR

videopage005

1. On the vehicle settings screen, press [Door].

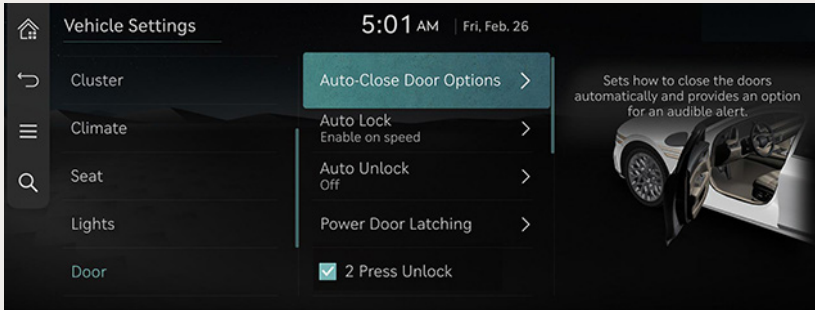

2. Press the desired item.
 - [Auto-Close Door Options]: Sets how to close the doors automatically and provides an option for an audible alert.
 - [Auto Lock]: Selects the timing for automatic locking all doors.
 - [Auto Unlock]: Selects the timing for automatic unlocking all doors.
 - [Power Door Latching]: Select door(s) that will not use power door latching.
 - [2 Press Unlock]: Press door unlock button of the key to unlock all doors.
 - [Approach Unlock]: Door handles will unlock when the smart key is nearby.
 - [Power Trunk]: The power trunk button can be used to automatically open/close the trunk.
 - [Power Trunk Open Height]: Sets the height of the opened trunk.
 - [Smart Trunk]: Opens the trunk lid automatically when approaching the trunk with the smart key.
 - [Remote Window]: Activate/deactivates the remote vehicle window control function.

DIGITAL KEY

videopage001

1. On the vehicle settings screen, press [Digital Key].

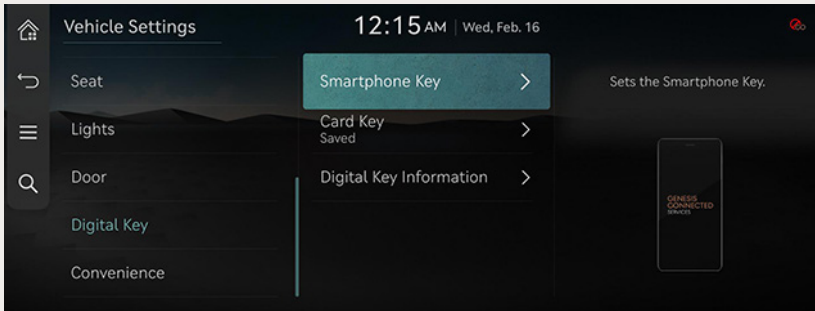

2. Press the desired item.
 - [Smartphone Key]/[Card Key]: Saves or deletes smartphone key or card key.
 - [Digital Key Information]: Shows the serial number of the digital key.

CONVENIENCE

1. On the vehicle settings screen, press [Convenience].

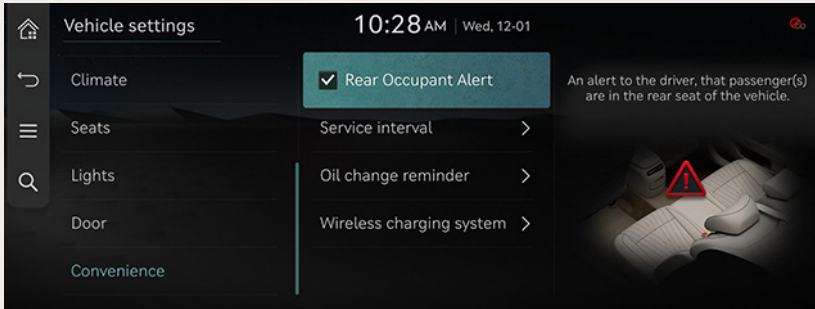

2. Press the desired item.

- [Rear Occupant Alert]: Provides an alert to the driver that passengers are in the rear seat of the vehicle.

videopage028

- [Service Interval]: Displays an alert when a scheduled service interval is reached.
- [Oil Change Reminder]: Displays remaining life of engine oil.
- [Wireless Changing System]: Enables the wireless charging pad to be used with compatible devices.

NAVIGATION SETTINGS

The images displayed on this system may differ from actual ones.

Press [Setup] > [Navigation] on the home screen.

The navigation settings screen is displayed.

MAP

1. Press [Map] on the navigation settings screen.

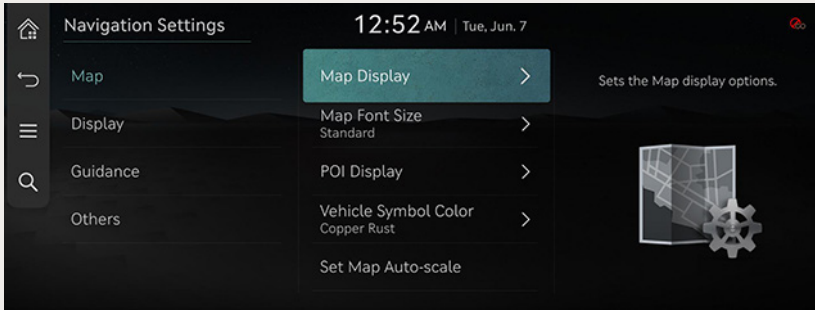

2. Press the desired menu.

- [Map Display]: Set the map display mode.
- [Map Font Size]: Set the font size of the map.
- [POI Display]: Select the POIs to display on the map.
- [Vehicle Symbol Color]: Set the vehicle symbol color.
- [Set Map Auto-scale]: Set auto scale based on the vehicle speed.

DISPLAY

1. Press [Display] on the navigation settings screen.

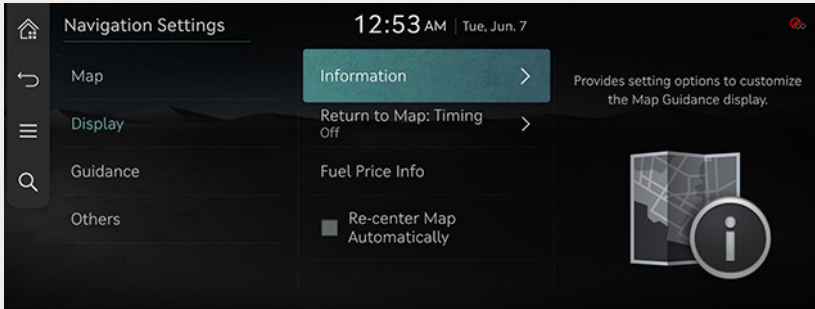

2. Press the desired menu.

- [Information]: Select the desired guidance information.
- [Return to Map: Timing]: After the selected time, the system automatically switches from radio/media to the navigation map screen.
- [Fuel Price Info.]: Sets the display of fuel price info for nearby gas and charging stations shown on the map.
- [Re-center Map Automatically]: Automatically returns to the current location after scrolling the map.

GUIDANCE

1. Press [Guidance] on the navigation settings screen.

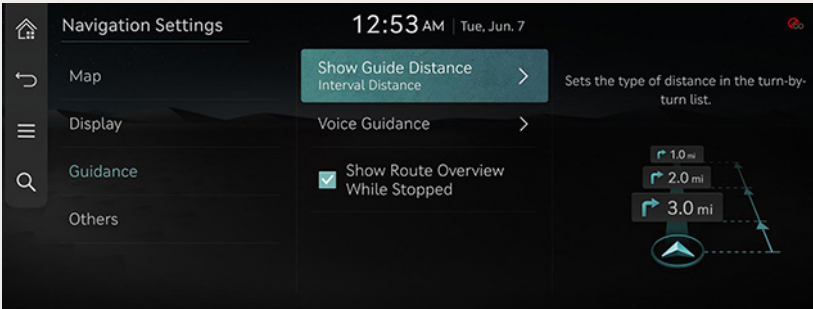

2. Press the desired menu.
 - [Show Guide Distance]: Set the type of distance on the turn-by-turn list.
 - [Voice Guidance]: Set the voice guidance.
 - [Show Route Overview While Stopped]: Shows the route overview while the vehicle is stopped.

OTHERS

1. Press [Others] on the navigation settings screen.

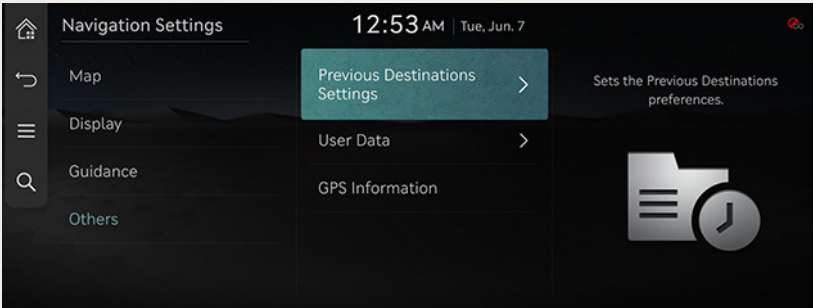

2. Press the desired menu.
 - [Previous Destinations Settings]: Set about previous destinations.
 - [User Data]: Saved addresses/previous destinations can be exchanged between compatible vehicles using a USB device.
 - [GPS Information]: Provides GPS information.

SOUND SETTINGS

The images displayed on this system may differ from actual ones.

On the home screen, press [Setup] > [Sound].

The sound settings screen is displayed.

! NOTE

When listening with headphones/earphones connected to the rear earphone connector, the sound settings are not applied. The sound settings are applied to the vehicle speakers.

ADJUSTING THE SOUND EFFECT (IF EQUIPPED)

Press the sound effect button on the media/broadcasting screen to adjust.

! NOTE

- However, this function is not provided in the sound settings.
- Sound effect can be set separately for each media/broadcasting mode.
- Phone projection/video streaming is linked with the BT sound effect settings.

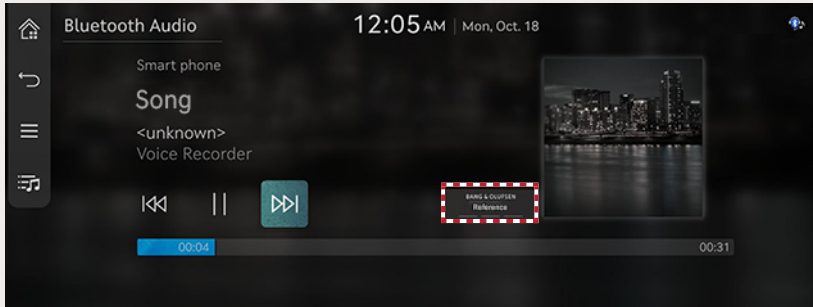

Description of sound effect modes by the specification.

Bang & Olufsen sound system (if equipped)

- [Reference]: [Delivers true sound focusing on original sound source.](#)
- [Surround]: [The surround sound technology identifies and re-authors individual sound sources into a precise multi-channel soundstage providing a 10-step surround effect enabling customized surround sound with variable intensity.](#)

Bang & Olufsen premier sound system (if equipped)

- [Reference]: [Delivers true sound focusing on original sound source.](#)
- [Surround]: [The surround sound technology identifies and re-authors individual sound sources into a precise multi-channel soundstage providing a 10-step surround effect enabling customized surround sound with variable intensity.](#)
- [Bang & Olufsen Home]: [An immersive in-cabin venue experience based on algorithms created by detailed and accurate measurements of where Bang & Olufsen's new innovations are perfected within the acoustics of a home.](#)
- [Boston Symphony Hall]: [An immersive in-cabin venue experience based on algorithms created by detailed and accurate measurements of Boston Symphony Hall, one of the world's top concert halls and the first built using acoustic principles.](#)

**Bang & Olufsen Home****Boston Symphony Hall**

PREMIUM SOUND

Sets the premium sound.

1. On the sound settings screen, press [Premium Sound].

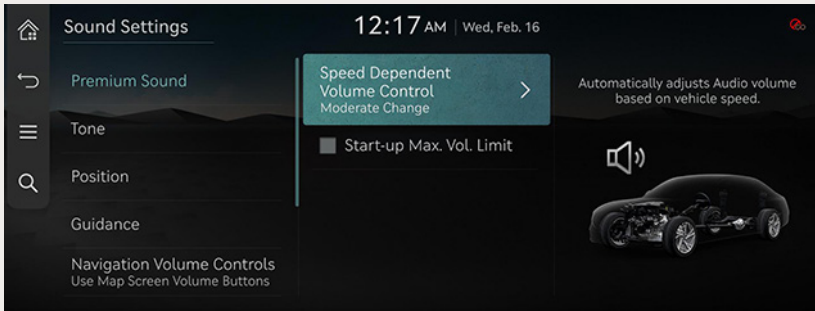

2. Press the desired item.
 - [Bang & Olufsen] (If equipped): Shows sound modes as reference and surround.
 - [Speed Dependent Volume Control]: It automatically adjusts volume according to vehicle speed.
 - [Start-up Max. Vol. Limit]: When starting vehicle engine, if audio volume is big, it decreases to adequate volume.

TONE

1. On the sound settings screen, press [Tone].

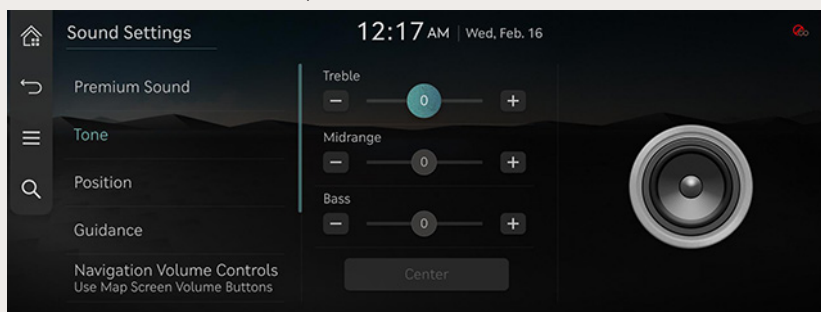

2. Adjust the desired items.

NOTE

Press [Center] to reset the settings.

POSITION

Adjusts the desired seat position.

1. On the sound settings screen, press [Position].

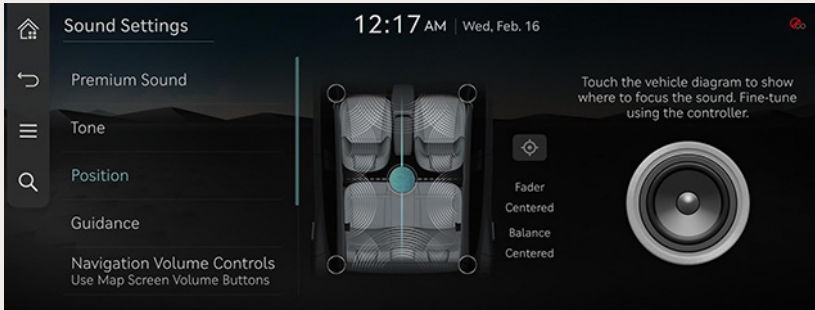

2. Press the desired seat position.

NOTE

Press [] to reset the settings.

GUIDANCE

1. On the sound settings screen, press [Guidance].

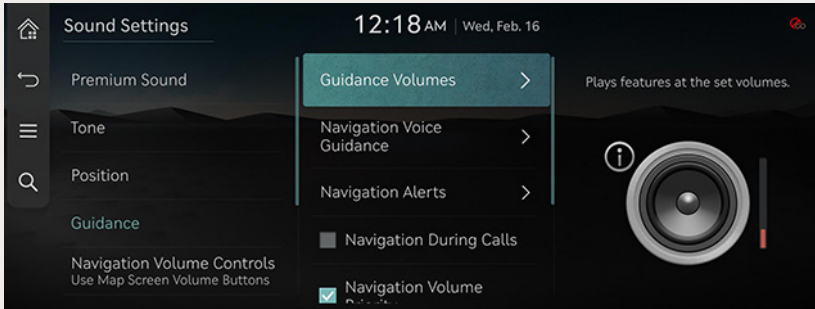

2. Select a desired item.
 - [Guidance Volumes]: Sets the guide volume.
 - [Navigation Voice Guidance]: Sets voice guidance preferences.
 - [Navigation Alerts]: Sets different types of navigation alerts.
 - [Navigation During Calls]: Plays audio navigation guidance during phone calls.
 - [Navigation Volume Priority]: Media volume will be lowered during navigation guidance.
 - [Mute Navigation Guidance]: While navigation guidance is playing, pressing the mute button on the steering wheel will mute guidance for 10 seconds.
 - [Welcome Sound]: Provides an audible tone when the cluster turns on or off.

ACTIVE SOUND DESIGN (IF EQUIPPED)

1. On the vehicle settings screen, press [Active Sound Design].

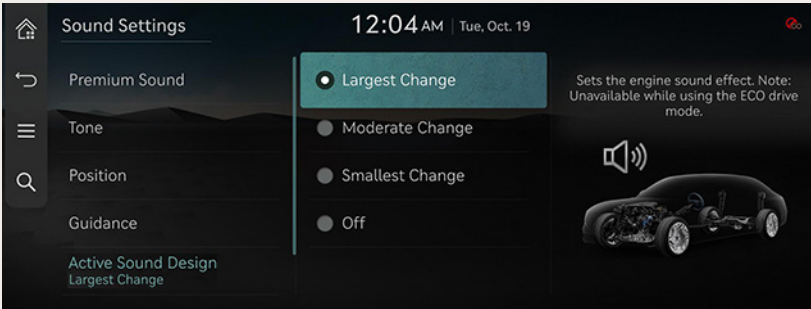

2. Press the desired items.
 - [Largest Change]/[Moderate Change]/[Smallest Change]/[Off]: Sets the engine sound effect, Note: Unavailable while using the ECO drive mode.

NAVIGATION VOLUME CONTROLS

Adjusts the navigation volume on the map screen or on the map screen and the knob.

1. On the sound settings screen, press [Navigation Volume Controls].

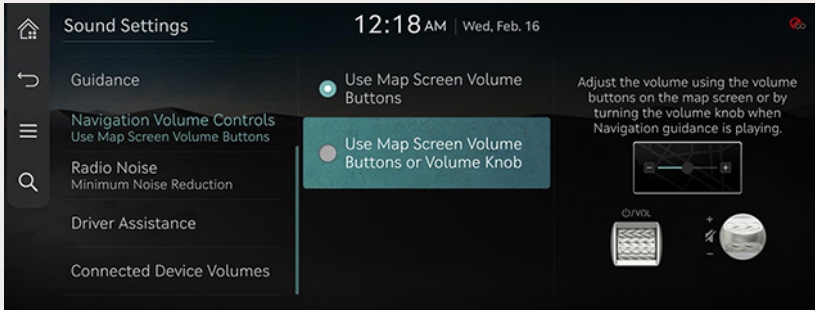

2. Select a desired item.

RADIO NOISE

Sets the radio noise.

1. On the sound settings screen, press [Radio Noise].

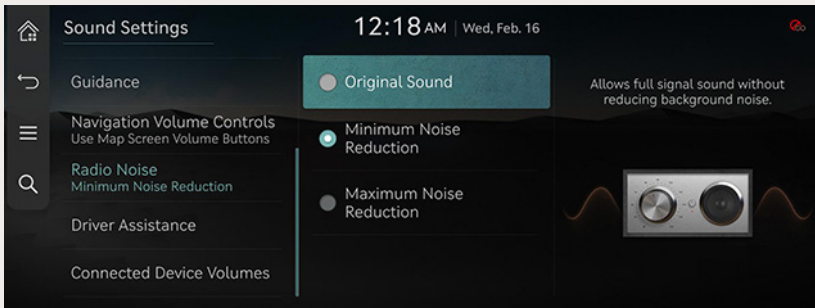

2. Select a desired item.

DRIVER ASSISTANCE

1. On the sound settings screen, press [Driver Assistance].

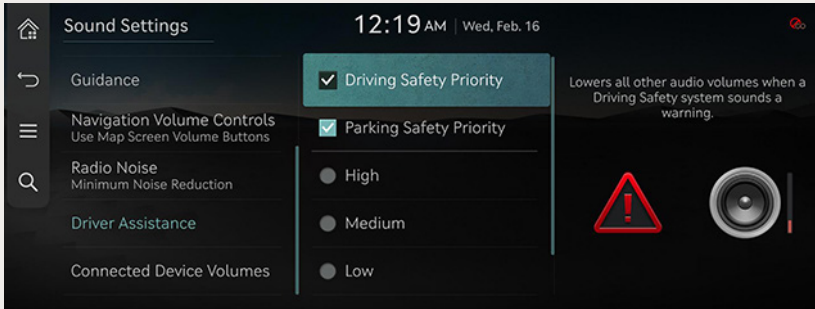

2. Select a desired item.

CONNECTED DEVICE VOLUMES

Sets the sound for Android Auto or Apple CarPlay.

1. On the sound settings screen, press [Connected Device Volumes].

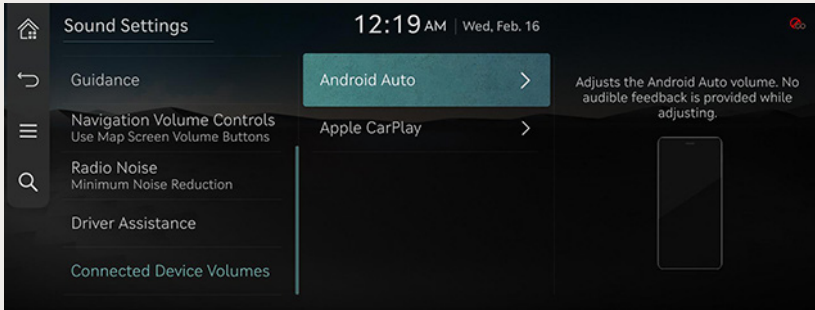

2. Press the desired item.

NOTE

- Press [Reset] to reset the volume of the connected device.
- Media playback stops when operating volume menu.

DEVICE CONNECTIONS SETTINGS

The images displayed on this system may differ from actual ones.

On the home screen, press [Setup] > [Device Connections].

The device connections settings screen is displayed.

DEVICE CONNECTIONS

On the device connections settings screen, press [Device Connections].

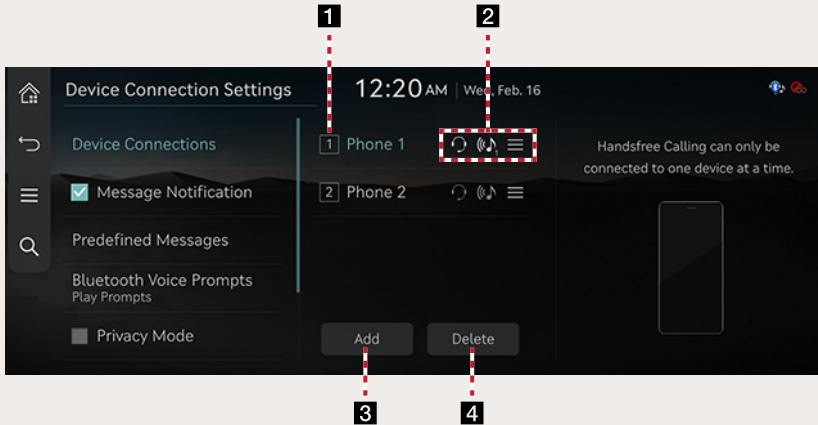

1 Registered device list

- Displays the list of registered Bluetooth devices.
- When you select the Bluetooth device in a list, it connects or disconnects the device.

2 Bluetooth hands-free/audio connection status

- Checks the connected Bluetooth hands-free or Bluetooth audio.
- Disconnects the desired Bluetooth hands-free or Bluetooth audio.

Auto connection priority

Automatically connect Bluetooth devices according to priority.

3 Add

Add a new Bluetooth device.

4 Delete

Deletes registered device.

MESSAGE NOTIFICATION

Selects to show notification pop-ups for received messages.

On the device connections settings screen, turn [Message Notification] on or off.

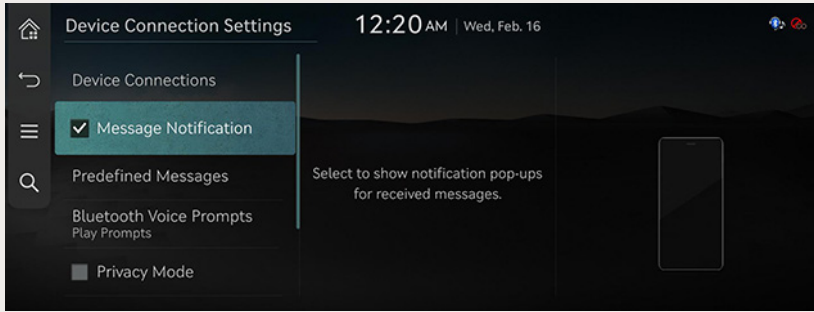

NOTE

Depending on the model of the connected Bluetooth device, this function may not be supported.

PREDEFINED MESSAGES

You can change registered reply messages.

1. On the device connections settings screen, press [Predefined Messages].

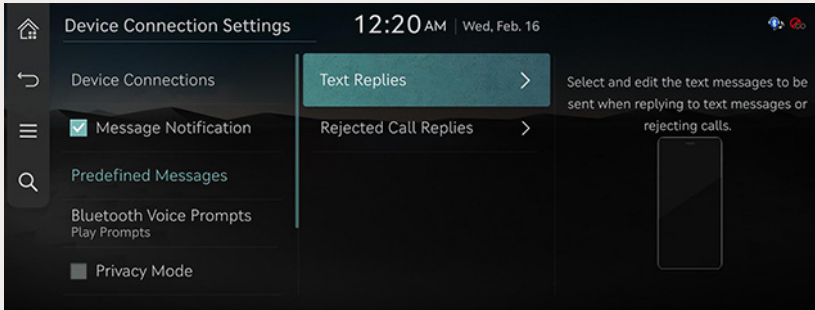

2. Press [Text Replies] or [Rejected Call Replies].
3. Select the messages you want to edit, and enter the message.

NOTE

Depending on the model of the connected Bluetooth device, [Predefined Messages] function may not be supported.

BLUETOOTH VOICE PROMPTS

Sets to play or mute Bluetooth voice prompts.

1. On the device connections settings screen, press [Bluetooth Voice Prompts].

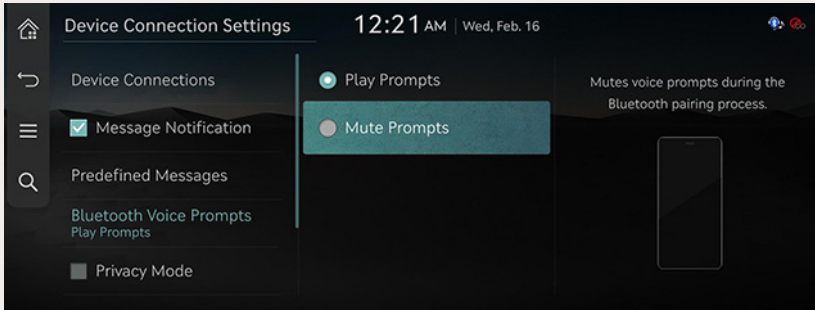

2. Press the desired item.

PRIVACY MODE

Sets to privacy mode for privacy.

If you set the privacy mode, private information including the phone book may not be displayed on the screen.

On the device connections settings screen, turn [Privacy Mode] on or off.



! NOTE

You can turn  > [Privacy Mode] on or off in the phone screen.

RR SEAT PRIVACY MODE

Sets the rear seat privacy mode to protect the privacy of the rear seat occupants.

On the device connections settings screen, turn [Rr Seat Privacy Mode] on or off.

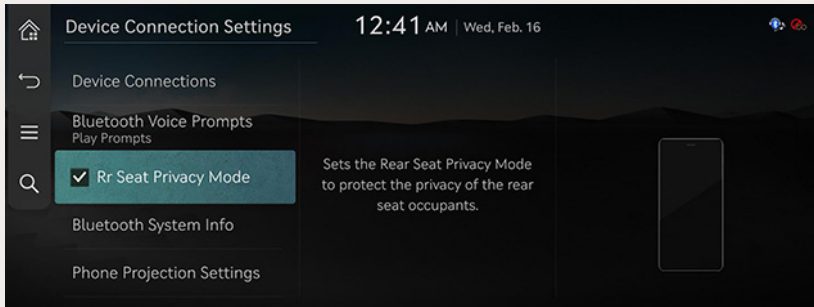

BLUETOOTH SYSTEM INFORMATION

Edits the vehicle name used to pair Bluetooth phones.

1. On the device connections settings screen, press [Bluetooth System Info].
2. Edit the vehicle name.

PHONE PROJECTION SETTINGS

Android Auto and Apple CarPlay are the supported phone projection options.

Enable the option to be used, then use an approved USB cable to connect a phone that supports the selected option.

On the device connections settings screen, press [Phone Projection Settings].



NOTE

You can not change the phone projection setting while the USB cable is connected.

DISPLAY SETTINGS

The images displayed on this system may differ from actual ones.

On the home screen, press [Setup] > [Display].

The display settings screen is displayed.

ILLUMINATION

Sets the screen brightness to adjust automatically, or manually set it to stay at a constant brightness level.

1. On the display settings screen, press [Illumination].

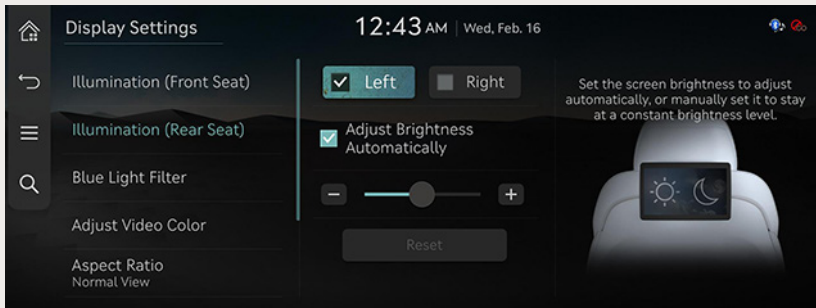
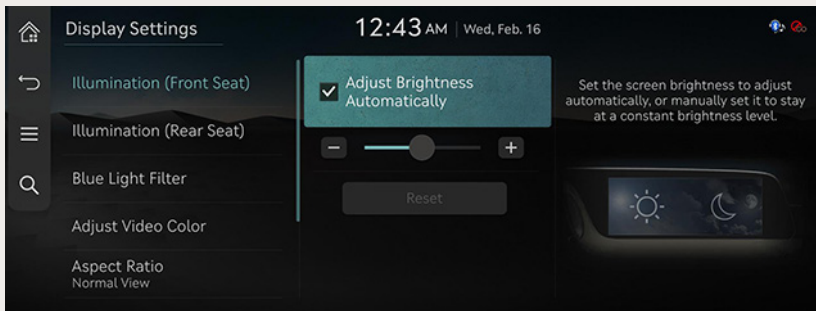

2. Select a desired item.

! NOTE

Visibility may decrease if the user adjusts the screen brightness to dark in a bright environment.

BLUE LIGHT FILTER

Sets blue light settings, such as warmth/coolness and time of use.

1. On the display settings screen, press [Blue Light Filter].

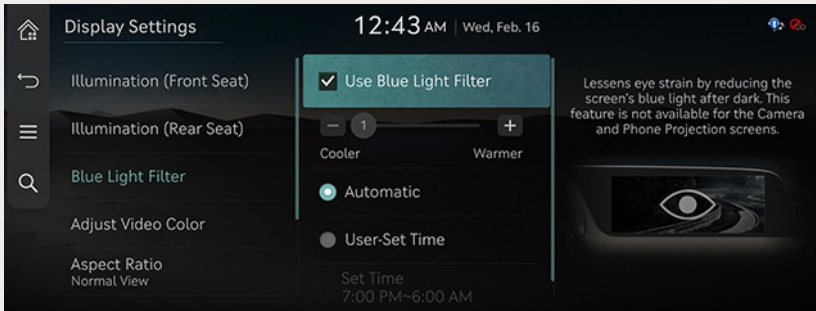

2. Press the desired item.
 - [Use Blue Light Filter]: Activates the blue light filter.
 - [Automatic]: Activates the blue light filter according to surrounding brightness.
 - [User-Set Time]: Activates the blue light filter according to the time set by the user.
 - [Set Time]: Sets the blue light filter time.

ADJUST VIDEO COLOR

During video playing, you can set brightness/contrast/saturation.

1. During video playing, press [Adjust Video Color].

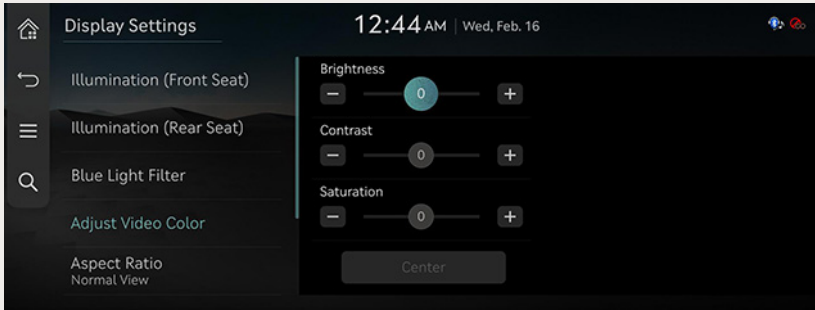

2. Adjust the desired items.

NOTE

Press [Center] to reset the settings.

ASPECT RATIO

You can select the desired size video screen to enjoy video with sense of realism.

1. During video playing, press [Aspect Ratio].

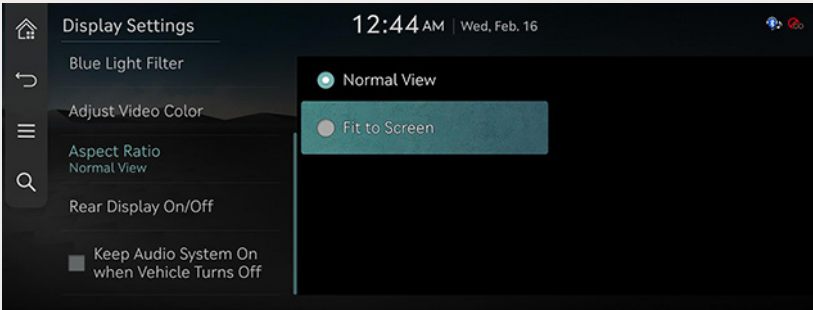

2. Select a desired item.

REAR DISPLAY ON/OFF (IF EQUIPPED)

Turns the rear display on or off.

1. On the display settings screen, press [Rear Display On/Off].

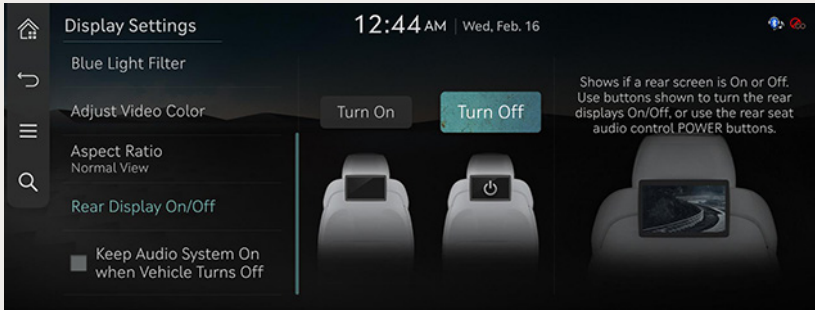

2. Press the [Turn On] or [Turn Off].

KEEP AUDIO SYSTEM ON WHEN VEHICLE TURNS OFF

Infotainment system screen will maintain power after turning off the vehicle. To turn off the system, open the vehicle door.

On the display settings screen, turn [Keep Audio System On when Vehicle Turns Off] on or off.

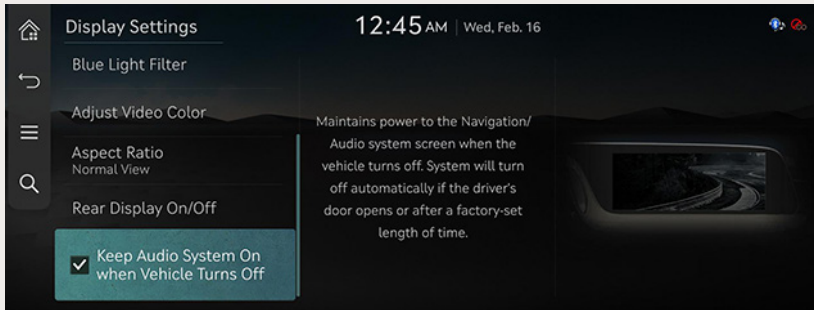

SCREEN THEME/LAYOUT SETTINGS

The images displayed on this system may differ from actual ones.

On the home screen, press [Setup] > [Screen Theme/Layout].

The screen theme/layout settings screen is displayed.

GRAPHIC THEMES

Selects a graphic theme.

1. On the screen theme/layout settings screen, press [Graphic Themes].

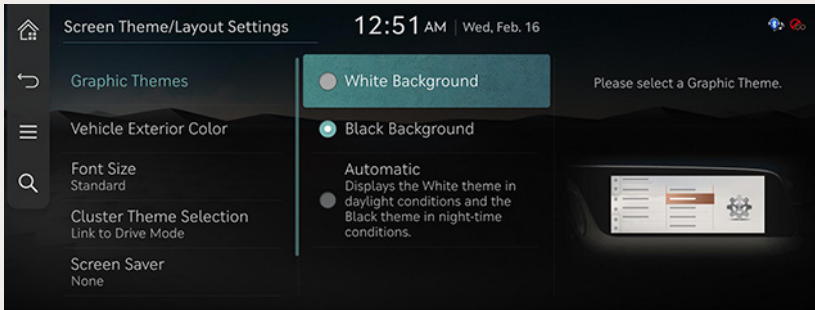

2. Select a desired item.

VEHICLE EXTERIOR COLOR

Selects a exterior color.

1. On the screen theme/layout settings screen, press [Vehicle Exterior Color].

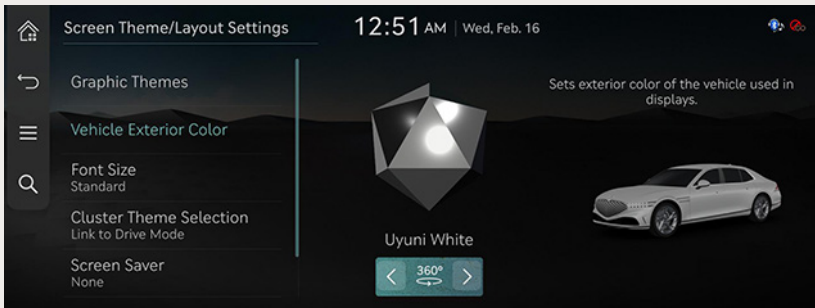

2. Select a desired item.

FONT SIZE

You can set the font size on the screen.

1. On the screen theme/layout settings screen, press [Font Size].

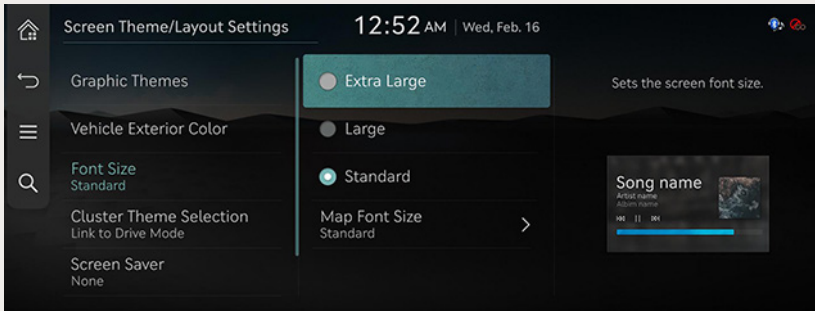

2. Select a desired item.

CLUSTER THEME SELECTION

1. On the screen theme/layout settings screen, press [Cluster Theme Selection].

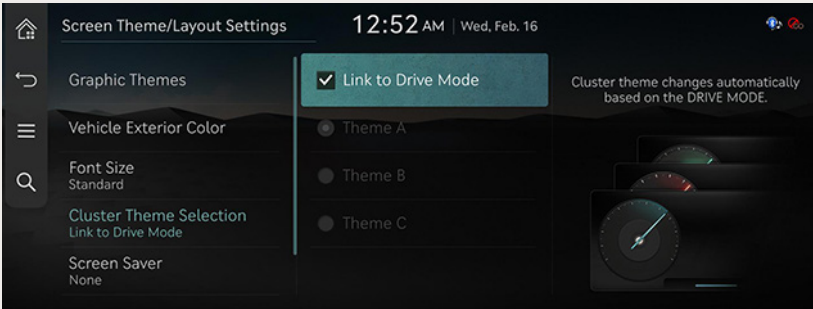

2. Select a desired item.

SCREEN SAVER

Displays image(s) downloaded from the smart phone app when the screen or power is turned off.

1. On the screen theme/layout settings screen, press [Screen Saver].

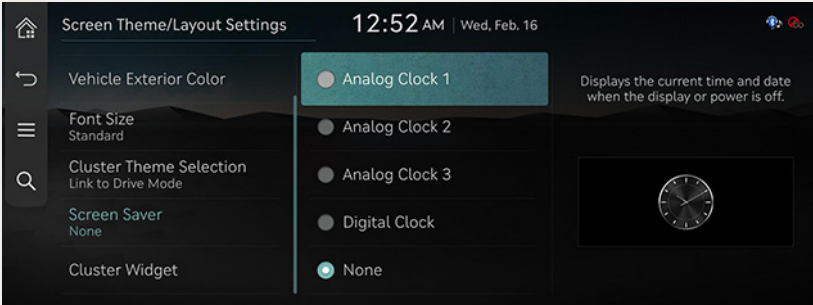

2. Select a desired item.

CLUSTER WIDGET

Selects the split screens shown and sets the order of their display.

1. On the screen theme/layout settings screen, press [Cluster Widget].

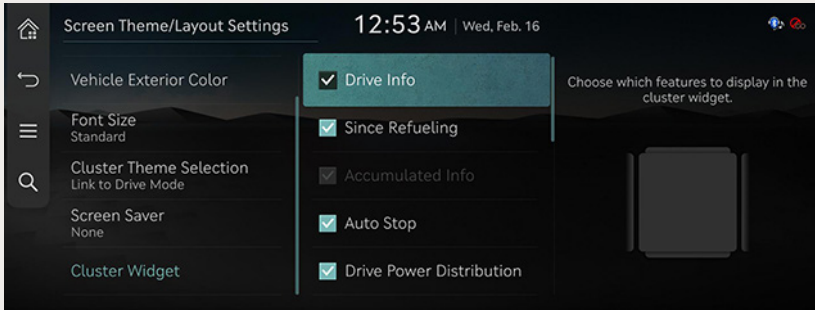

2. Select a desired item.

BUTTON/TOUCH PAD SETTINGS

The images displayed on this system may differ from actual ones.

On the home screen, press [Setup] > [Button/Touch Pad].

The button/touch pad settings screen is displayed.

CUSTOM BUTTON

Selects a function for the custom button.

1. On the button/touch pad settings screen, press [Custom Button ☆ (by Radio)], [Custom Button ● (Steering Wheel)] or [Custom Button ★ (Steering Wheel)].

- Custom Button ☆ (by Radio)

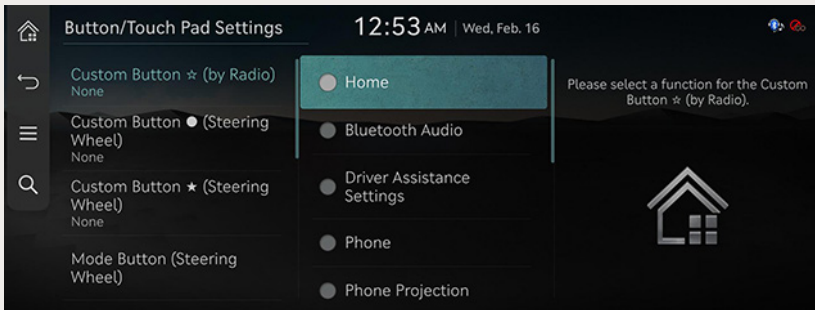

- Custom Button ● (Steering Wheel)

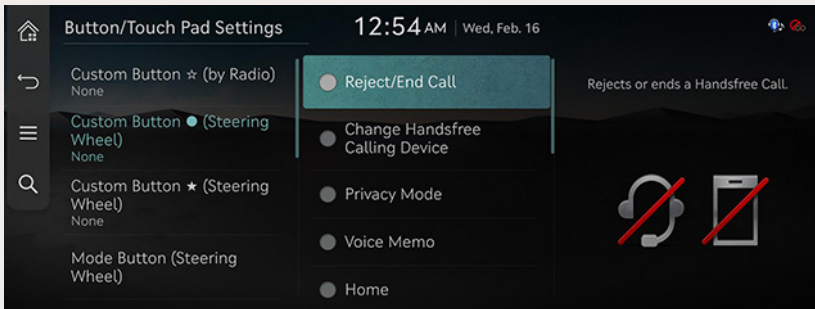

- Custom Button ★ (Steering Wheel)

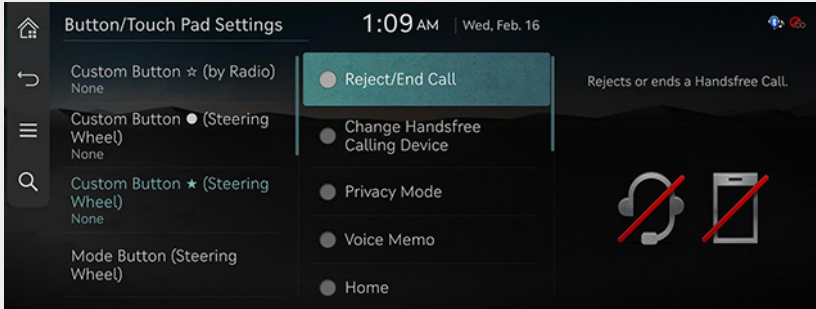

2. Select a desired item.

MODE BUTTON (STEERINGWHEEL)

Selects the media can be accessed using the [MODE] button on the steering wheel.

1. On the button/touch pad settings screen, press [Mode Button (SteeringWheel)].

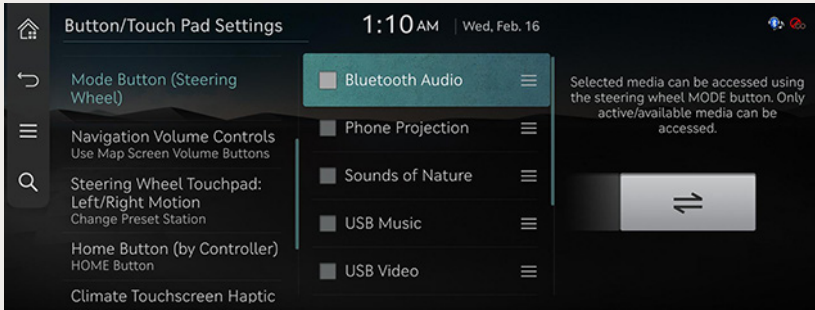

2. Select a desired item.

NAVIGATION VOLUME CONTROLS

Adjusts the navigation volume on the map screen or on the map screen and the knob.

1. On the button/touch pad settings screen, press [Navigation Volume Controls].

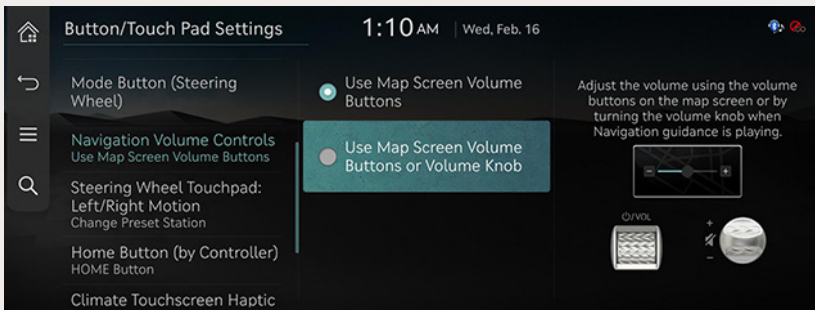

2. Select a desired item.

HOME BUTTON

Sets the operation method when the [HOME] button on the head unit is pressed.

1. On the button/touch pad settings screen, press [Home Button (by Controller)].

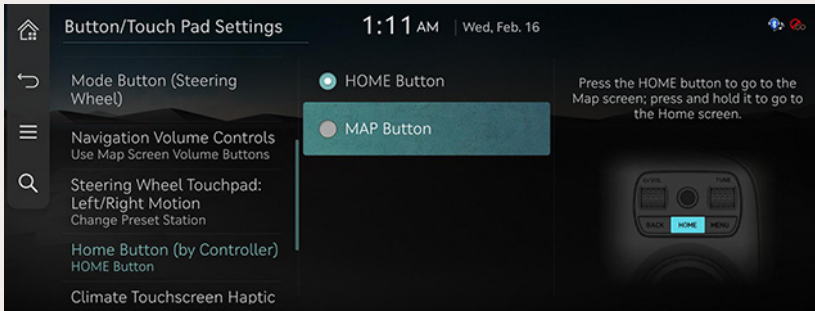

2. Select a desired item.

CLIMATE TOUCHSCREEN HAPTIC INTENSITY

Adjusts the touch feedback intensity felt when the climate screen is pressed.

1. On the button/touch pad settings screen, Press [Climate Touchscreen Haptic Intensity].

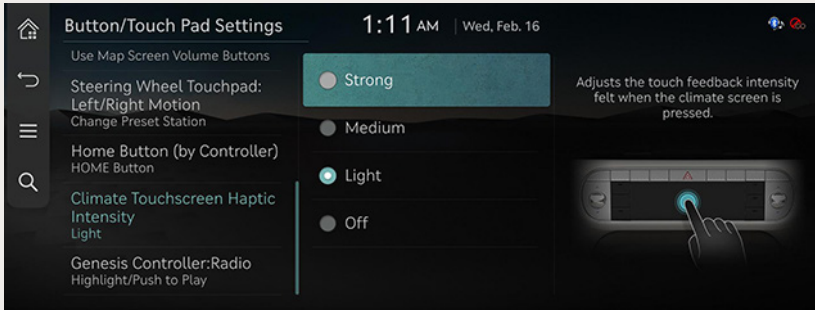

2. Select a desired item.

GENESIS CONTROLLER

Sets how to play a selection on the radio playing screen when using controller.

1. On the button/touch pad settings screen, press [Genesis Controller:Radio].

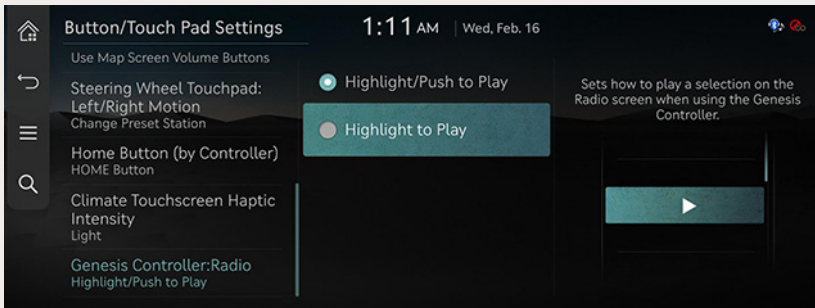

2. Select a desired item.

LOCK REAR CONTROLLERS

Locks the controller used by rear seat passengers.

On the button/touch pad settings screen, press [Lock Rear Controllers].

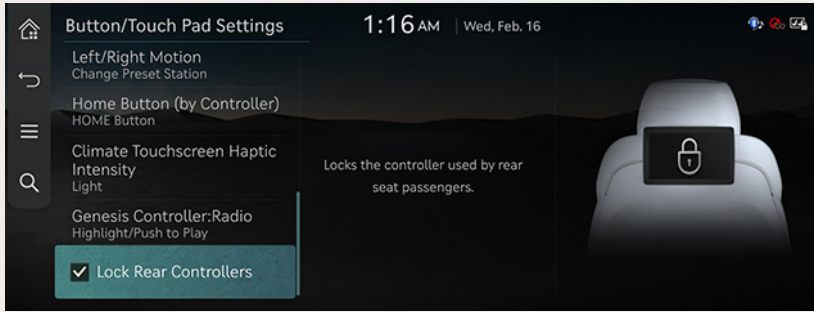

GENERAL SETTINGS

The images displayed on this system may differ from actual ones.

On the home screen, press [Setup] > [General].

The general settings screen is displayed.

SYSTEM INFORMATION CHECKING

SOFTWARE INFORMATION

You can check the version information applied to the system.

On the general settings screen, press [SW Info/Update].

NOTE

Software information is applied differently according to the system update time point.

UPDATE

For supplementation of system software, addition of new functions, and more, update is needed.

You can update latest map and software by downloading the Navigation Updater program from internet site (<http://update.genesis.com>) and through USB.

For details on update, check from internet site and carry out.

1. Download the latest file to USB and connect it to the USB terminal.
2. On the general settings screen, press [SW Info/Update] > [Update].
3. If you press [Background Update], update is in progress. After completion, turn off the engine and the system automatically reboots.

NOTE

- Update may take dozens of minutes according to data size.
- During update process, if power is blocked or USB is removed, data may be damaged, so be careful.

SYSTEM INFORMATION

1. On the general settings screen, press [System Info].

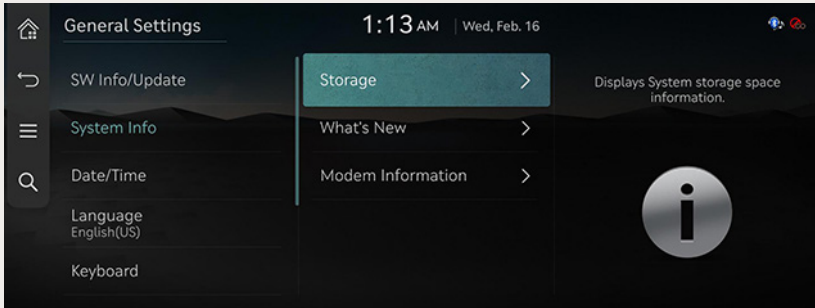

2. Select a desired item.
 - [Storage]: Displays the storage space of the voice memo currently in use.
 - [What's New]: Checks update history.
 - [Modem Information]: Checks the modem information.

DATE/TIME

1. On the general settings screen, press [Date/Time].

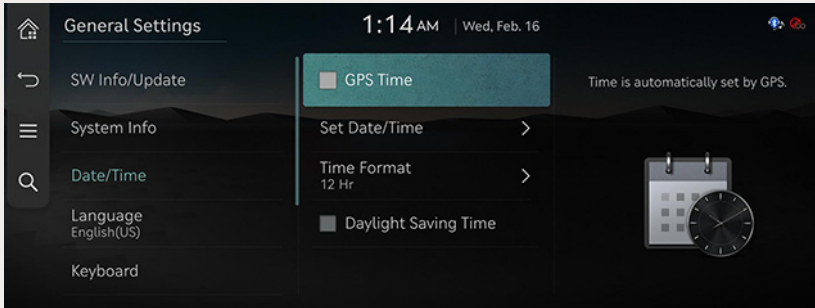

2. Press the desired item.
 - [GPS time]: Time is automatically set by GPS.
 - [Set Date/Time]: Sets time applied to the system.
 - [Time Format]: Sets the time format.
 - [Daylight Saving Time]: Sets the daylight savings time.

NOTE

- To manually set the time, use it after changing [GPS time] setting to off.
- When [Daylight Saving Time] is turned on, the clock is adjusted forward one hour.

LANGUAGE

You can set the language of the system display and voice language.

1. On the general settings screen, press [Language].

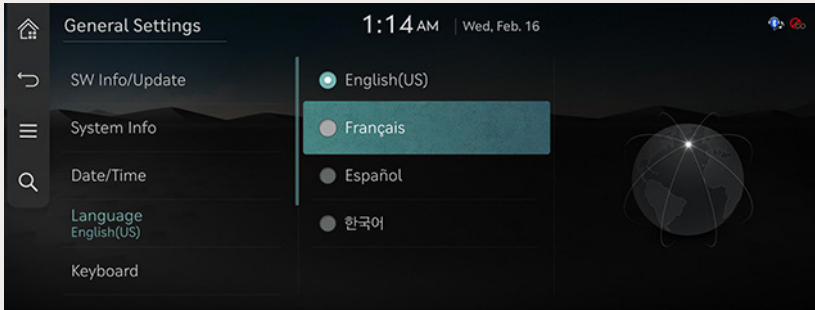

2. Select a desired item.

KEYBOARD

videopage008

You can set type of keyboard used in the system.

1. On the general settings screen, press [Keyboard].

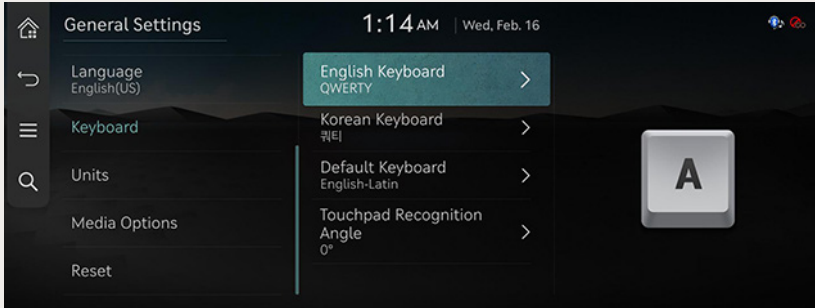

2. Select a desired item.

! NOTE

When you adjust the angle of handwriting and touch gesture recognition based on individual posture, press [Touchpad Recognition Angle].

UNITS

You can set the units used in the system.

1. On the general settings screen, press [Units].

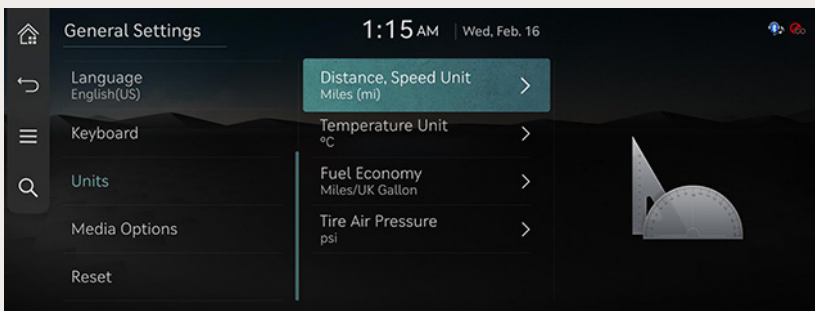

2. Select a desired item.

MEDIA OPTIONS

1. On the general settings screen, press [Media Options].

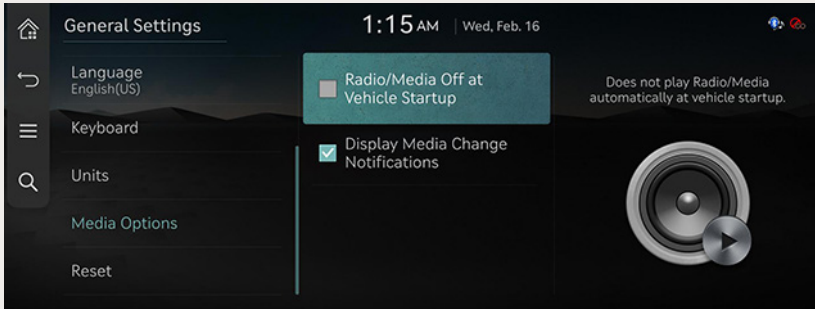

2. Select a desired item.
 - [Radio/Media Off at Vehicle Startup]: Stops media playback when engine is turning off. Media playback will not resume whilst engine is started up again.
 - [Display Media Change Notifications]: Briefly display media information whenever the content changes, except on media playing screen.

RESET

All stored data and profile settings will be lost and the system will be reset.
On the general settings screen, press [Reset].

USER PROFILE SETTINGS

videopage013

The images displayed on this system may differ from actual ones.

On the home screen, press [Setup] > [User Profile].

The user profile settings screen is displayed.

CHANGE USER PROFILE SETTINGS

Changes or reset the settings related to the profile.

1. On the user profile settings screen, press [Guest]/[Driver 1]/[Driver2].

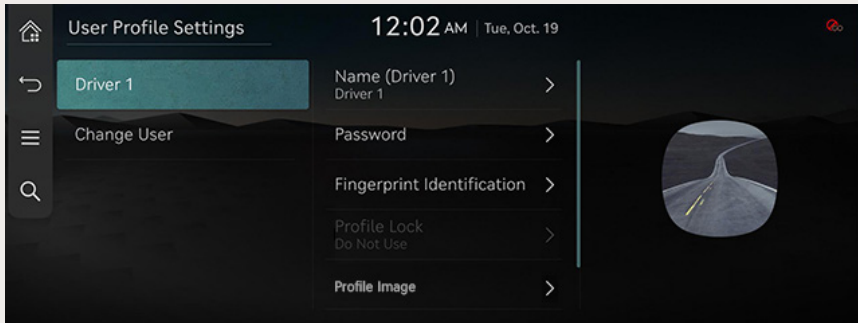

2. Press the desired item.

- [Name]: Changes the user name.
- [Password]: You can set the password when selecting the profile which is the connected services account.
- [Fingerprint Identification]: By setting your fingerprint, you can use fingerprint identification instead of a password for various convenience functions.

videopage026

- [Profile Lock]: You can set whether to use a password to access this profile.
- [Profile Image]: Selects an image to be used as a profile.
- [Link Connected Services Account]: You can link it after enabling the digital key setting in the vehicle settings.
- [Delete Driver 1/2 Profile]: All saved data and profile settings are deleted, and the system is initialized.

CHANGE USER

1. On the user profile settings screen, press [Change User].

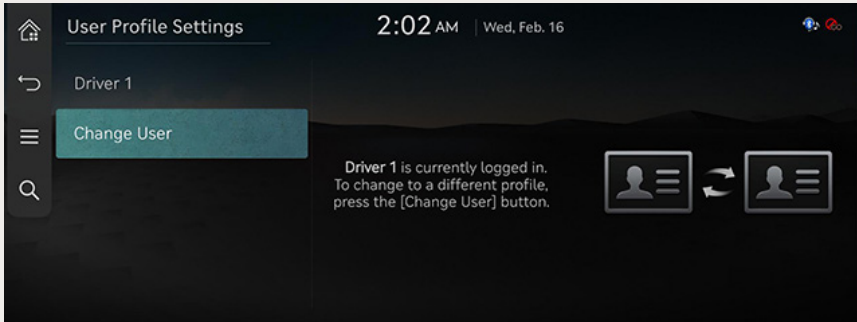

2. Select the desired profile.
3. When the profile is changed, safety warning page is displayed.

VOICE RECOGNITION SETTINGS

The images displayed on this system may differ from actual ones.

1. On the home screen, press [Setup] > [Voice Recognition].

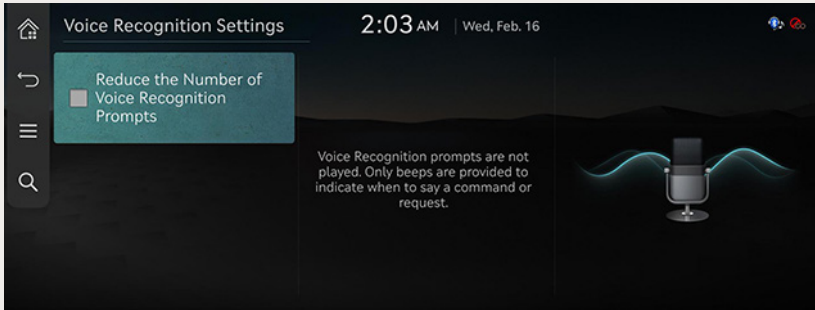

2. Press the desired item.

! NOTE

- Voice recognition support availability varies according to the language set for the system.
- Please verify the current language setting before using the voice recognition.

CONNECTED SERVICES SETTINGS

CONNECTED SERVICE

The images displayed on this system may differ from actual ones.

1. On the home screen, press [Setup] > [Connected Services].

< USA >

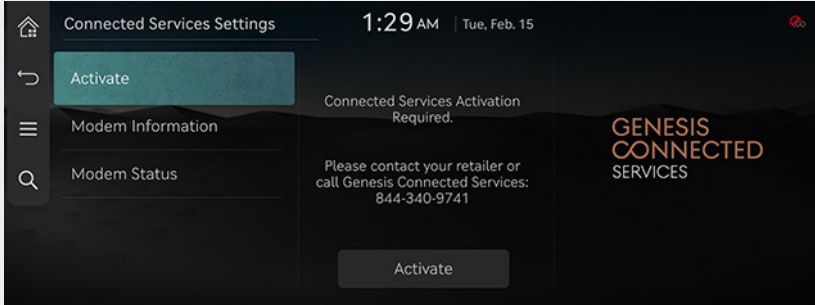

< Canada >

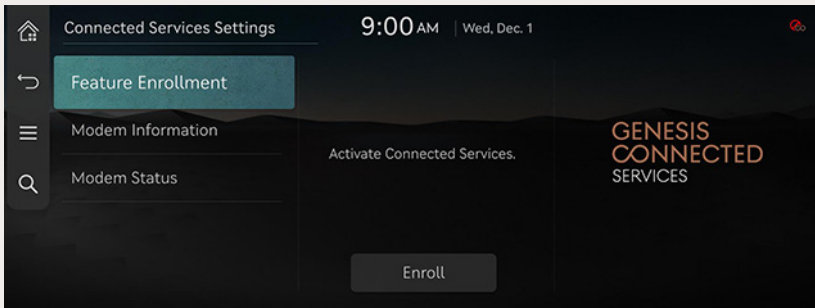

2. Select a desired item.

- [Activate]/[Feature Enrollment]: Activates the service.
- [Modem Information]: Checks the modem information.
- [Modem Status]: Checks the modem status.

UPDATE



WIRELESS UPDATE

videopage014

Downloads and installs the latest map and software automatically through wireless update.

After update, you can check the result by scanning QR code.

The images displayed on the screen can be differ from the actual one.

If you have signed up for Genesis Connected Services, the system is updated automatically when turning on the engine whenever there is a latest version.

1. When turning on the engine, the update file is downloaded and the download icon is displayed in top right of the screen.

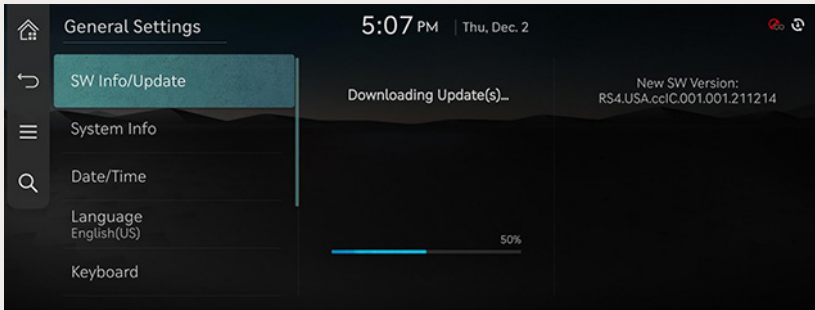

2. After finishing download, software and navigation are updated and the update icon is displayed in top right of the screen.

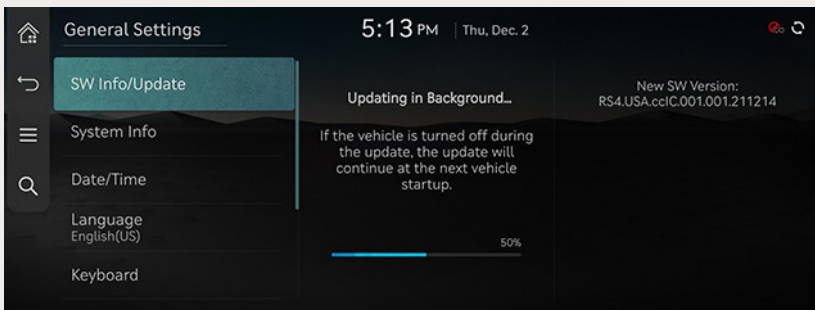

3. After update, a message turns up for the last step.

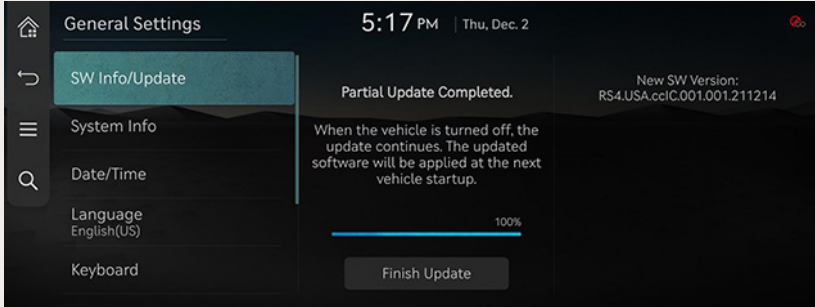

4. If you press [Finish Update] button, a message turns up for the last step.
5. The navigation system will restart and during the installation of the latest software of it, all functions including the sound are restricted.
6. After update, you can find update record [System Info] > [What's New] on the general settings screen.

A green circular icon containing a white exclamation mark.**NOTE**

- This function is offered during the subscription on Genesis Connected Services.
- Even if the engine is turned off and on again during the update, update is resumed.
- What's new is not displayed right after purchasing the vehicle or in case that update has never been performed.
- If the system failed update, the wireless update is performed automatically when next latest version is distributed.

USB UPDATE

1. Insert latest file downloaded USB to USB connector at front seat.
2. On the general settings screen, press [SW Info/Update] > [Update].

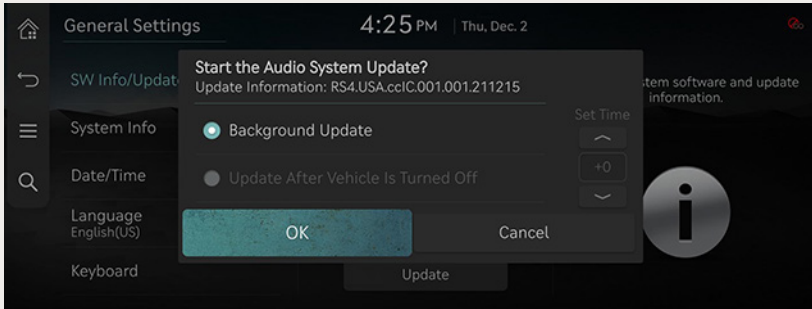

- [Background Update]: To perform update while using the system.
 - [Update After Vehicle Is Turned Off]: To update the navigation and infotainment system while not using the vehicle. (Make sure that a USB device with update files is connected to the system before turning off the vehicle.)
3. Validating update files in USB device.

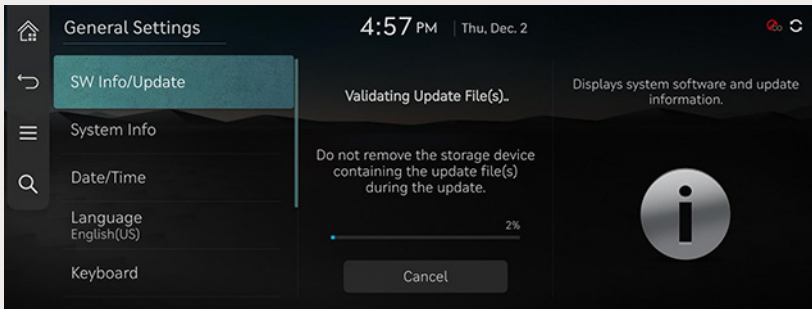

4. Software and navigation are updated and the update icon is displayed in top right of the screen.



5. After update, a message turns up for the last step.

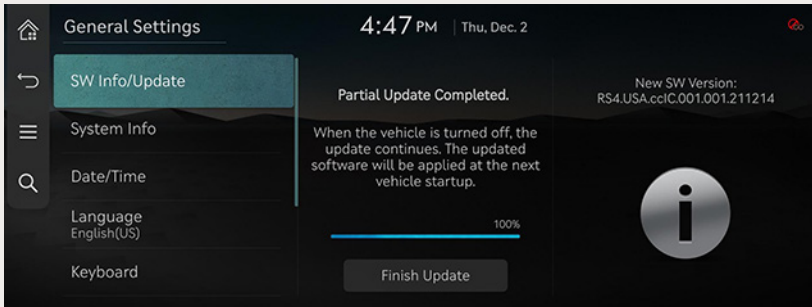

6. If you press [Finish Update] button, a message turns up for the last step.
7. The navigation system will restart and during the installation of the latest software of it, all functions including the sound are restricted.
8. After update, you can find update record [System Info] > [What's New] on the general settings screen.

NOTE

All features can be used during the update, but this may slow down the system.

OTHERS



USING PHONE PROJECTION

WHAT IS ANDROID AUTO/APPLE CARPLAY?

Securely access your smartphone while driving.

Various functions of your smartphone are displayed on and operable from the screen of the media device (ex. navigation, making a call, listening to music etc.)

When connected, an Android Auto/Apple CarPlay icon appears on the screen.

Available functions and operations may differ depending on the company model.

For more information, visit the Google or Apple website.

- Google: <http://support.google.com/androidauto/>
- Apple: <http://www.apple.com/ios/carplay/>

Cautions

- Android Auto is a registered trademark of Google Inc.
- Apple CarPlay is a registered trademark of Apple Inc.
- Android Auto and Apple CarPlay are unavailable if the phone OS is not the latest version or if the phone cannot be recognized due to a shutdown caused by a failure or defect in the device itself.
- Your phone may not be recognised if its battery is low. Charge your phone then try again.
- If your phone is shut down due to a defect in the device itself, reset your phone and try again.
- If the USB cable of the Android Auto/Apple CarPlay device is repeatedly disconnected and reconnected in a short period of time, the phone may malfunction. This can also cause a device failure.
- The device recognition time may differ depending on the device type and firmware/OS version.
- Using the USB cable that came with the phone is recommended. (Using a non-genuine product may cause noise or malfunction.)
- Normal operations cannot be guaranteed if the phone is arbitrarily manipulated while Android Auto/Apple CarPlay is active.
- Android Auto or Apple CarPlay may not operate normally due to mobile phone issues.
- Carrier charges may apply when using Android Auto or Apple CarPlay.
- Some features may not operate normally according to the version of iOS and Android.

※ The following problems may occur due to phone-related issues:

- [Android Auto]
 - Intermittent black screens appear when entering Android Auto.
 - Differentiation of phones that support Android Auto and those which do not, may not be possible.
 - Black screens appear in some areas of the screen due to app errors.
- [Apple CarPlay]
 - Intermittent black screens appear when entering Apple CarPlay.
 - Black screens appear in some areas of the screen due to app errors when navigating between screens in Apple CarPlay.
 - Audio volume cannot be adjusted depending on the status of a connected mobile phone.
 - The sound output of a call may be cut upon disconnecting Apple CarPlay during a call via Apple CarPlay.

 **NOTE**

If services do not work properly due to problems similar to the specified above, check your phone, and if necessary, reconnect your phone after restarting.

USING ANDROID AUTO/APPLE CARPLAY

1. To connect your mobile phone to the USB port, use a genuine Apple USB cable for Apple CarPlay, and use a standard USB cable for Android Auto.
2. Select [Android Auto] or [Apple CarPlay] on the home screen.
3. You can use the features such as navigation, music, phone, etc, provided by Android Auto or Apple CarPlay.

NOTE

- To use Android Auto or Apple CarPlay after connecting your mobile phone, please unlock it.
- You may need to agree to use Android Auto or Apple CarPlay, depending on the type of the mobile phone you use.
- The screens and features displayed in the infotainment system can be changed according to the policy of each company.

Cautions - Android Auto

- Bluetooth media features will be disabled when Android Auto is activated.
- After removing the USB cable, these features will be available again.
- If Android Auto is not activated even after a successful connection, follow these steps:
 - Check whether an error occurred on the phone.
 - Check whether Android Auto has been closed on the phone.
 - Check whether Android Auto is activated in the phone projection settings.
- If Android Auto does not work normally even after a reconnection has been made, visit the Google website. (<http://support.google.com/androidauto/>)
- Please refer to the following websites to check the available countries for the Android Auto. (<https://www.android.com/auto>)

Cautions- Apple CarPlay

- Bluetooth phone/media features will be disabled when Apple CarPlay is activated.
- After removing the USB cable, these features will be available again.
- If Apple CarPlay is not activated even after a successful connection, follow these steps:
 - Check whether Apple CarPlay is disabled in the iPhone's application settings.
 - Check whether Apple CarPlay is activated in the phone projection settings.
- If Apple CarPlay does not work normally even after a reconnection has been made, visit the Apple website. (<http://www.apple.com/ios/carplay/>)
- Please refer to the following websites to check the available countries for the Apple CarPlay. (<http://www.apple.com/ios/feature-availability/>)

USING VOICE MEMO

CREATING A VOICE MEMO

1. Press [Voice Memo] on the home screen.

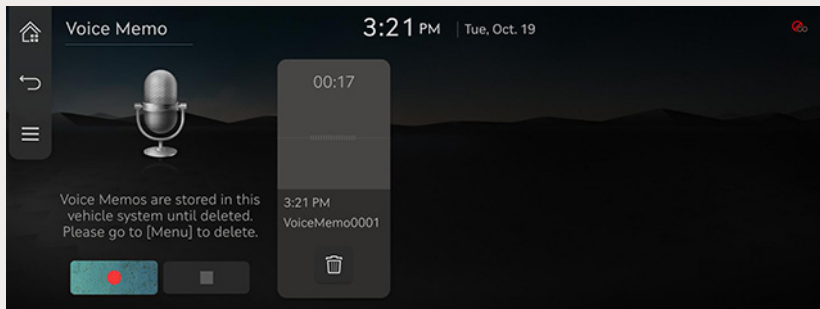

2. Press [●] on the voice memo screen.
3. Record a voice memo.

Location	Details
Screen	<ul style="list-style-type: none"> • To pause voice memo recording, press [■]. Press [●] to start recording again. • To stop recording the voice memo, press [■].

! NOTE

- All the sounds from this unit will not be output while the voice memo is operating.
- Voice memo pauses when you receive a Bluetooth phone call while the voice memo is operating.
- The location where you started recording is displayed at the top of the list of voice memo
- When the storage space is full during a voice memo, the voice memo is automatically saved and ends.
- [★] is available when you set to voice memo in the custom button settings.

RUNNING VOICE MEMO

PAUSE/PLAY VOICE MEMO

1. Select the voice memo you want to play in the voice memo list. The relevant voice memo is played.

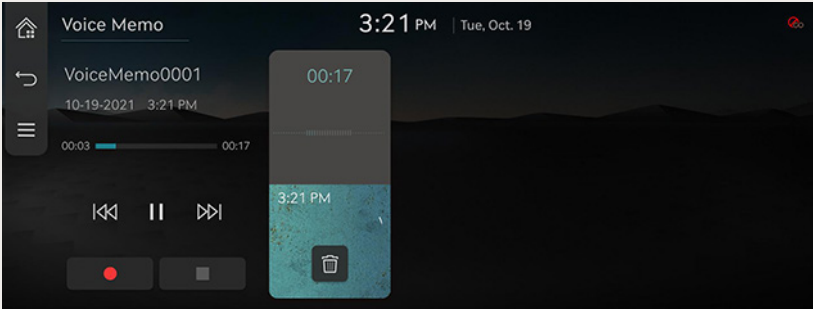

2. Press [⏸] to pause the playback of a voice memo.
3. Press [▶] to resume the playback while a voice memo is paused.

PLAY PREVIOUS/NEXT VOICE MEMO

Plays the previous/next voice memo.

Location	Details
Screen	Touch [⏮/⏭].

FORWARD/REVERSE SEARCH VOICE MEMO

Rapidly searches the voice memo in play.

Location	Details
Screen	Touch and hold [⏮/⏭], and release it to play the part.

! NOTE

- When pressing [⏮/⏭] for 5 seconds or longer, the play speed changes as 4X > 20X.
- No audio is on during forward/reverse searching.

DELETING VOICE MEMO

1. Press  > [Delete] on the voice memo screen.

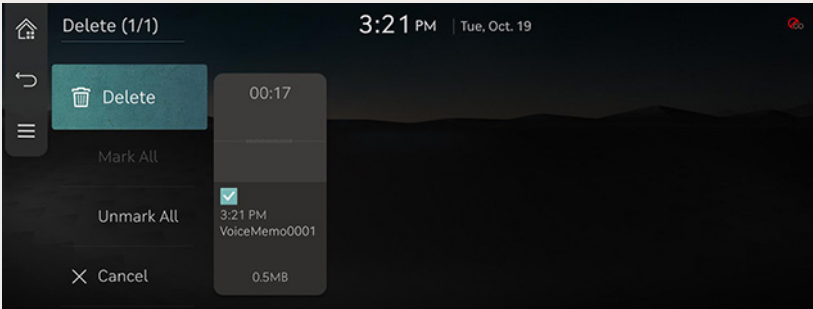

2. Select the desired item, press [Delete] > [Yes].

SAVING A VOICE MEMO TO USB

1. Connect USB to the USB port.
2. Press  > [Save to USB Device] on the voice memo screen.

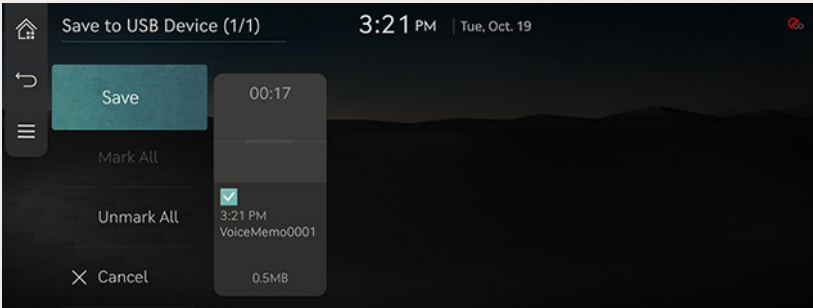

3. Select the desired item, press [Save].

NOTE

- It can be saved to a USB memory formatted with FAT 16/32 or exFAT/NTFS.
- When saved to USB, a voice memo is copied to "VoiceMemo" folder and saved.



USING VOICE RECOGNITION SYSTEM

WHAT IS VOICE RECOGNITION?

Voice recognition technology runs the system as ordered by recognizing your voice command to help with the operation of media while you are driving the car.

Regretfully, not all possible voice commands are recognized by the system due to technological limitations.

To make up for these limitations, the system displays the voice commands that are available for you to use.

There are errors in communication between people.

Likewise, voice recognition sometimes misunderstands your voice command under certain circumstances.

If this happens, either check the screen for the available options and say the command again, or manually select and press the button for the corresponding command on the screen.

VOICE RECOGNITION FEATURES BY LANGUAGE

Voice recognition support availability varies according to the language set for the system.

Please verify the current language setting before using the voice recognition.

- If you change the language set for the system to Korean, voice recognition will not be supported. Change the system language to other language.



OPERATING VOICE COMMANDS

CONDITION FOR VOICE COMMANDS SYSTEM

Most of the functions can be operated by voice.

Please follow the instructions below for optimal voice recognition performance.

- To improve the voice recognition performance, keep your car interior quiet by closing all windows and the sunroof.
- Press the voice recognition button and say the desired voice command after the beep sound.
- The microphone is positioned above the driver. Voice commands should be spoken by driver practicing proper posture.
- Pronounce the voice commands naturally and clearly as if in a normal conversation.
- Special symbols of Phonebook Name are not considered in voice recognition. Ex) James-Smith : "James Smith"
- House number or digits in Phonebook Name should be spoken discretely. Ex) S1234 : "South one two three four"
- Depending on the specifications, some commands may not be supported.

STARTING VOICE RECOGNITION

1. Press the voice recognition button on the steering wheel remote control.
2. Say the desired voice command after the beep sound.

NOTE

- For proper recognition, please say the command the voice instruction after the beep sound.
- You can set the voice recognition guide sound. For more details, refer to the "Voice recognition settings".

SKIPPING PROMPT MESSAGES

Press the voice recognition button on the steering wheel remote control briefly again during the voice recognition guidance.

ENDING VOICE RECOGNITION

1. Press and hold the voice recognition button on the steering wheel remote control while voice recognition system is operating.
2. While the voice recognition system is operating, press any button on the head unit or press the [Exit] on the screen.

ADJUSTING VOICE RECOGNITION VOLUME

During the voice recognition system operation, the volume can be adjusted with the volume button on the front seat control key or the volume button on the steering wheel remote control.

VOICE RECOGNITION COMMANDS LIST

Voice recognition commands are classified as "Global Commands" and "Local Commands".

- Global commands (●) : Commands that can be used immediately after activating voice recognition.
- Local commands (□) : Commands that can be used in specific multimedia/navigation/Bluetooth mode states.

NOTE

Some commands will operate properly only when a USB, Bluetooth or other device has been connected.

Basic commands

Command		Operation
●	Commands (Help)	Goes to the voice recognition help screen. All available commands can then be identified and used.
□	Yes/No	When voice recognition is active, this command is used when an answer is requested for a confirmation question.
□	Line 1-4 (One-Four)	When you cannot select a certain name, such as in call history, you can select it using line number. Simple numbers, such as "one" and "two", can be recognized.
□	Next/Previous	When five or more searched items are listed, you can move to the previous or next page using a voice command.
□	Go Back (Back)	Goes back to the previous screen.
●	Exit	Ends the voice recognition.

Radio commands

Command		Operation
●	FM	It plays FM radio.
●	AM	It plays AM radio.
●	SiriusXM	It plays SiriusXM radio.

Phone commands

- Voice commands related to phone calls can be used after connecting the Bluetooth phone device.
- To call a person, you must first download the mobile phone contacts.
- After downloading the Bluetooth phone contacts, it will take some time to convert the phone contacts into voice data during which time you cannot make a call by name yet.
- The time that it taken to convert voice data may vary depending on the number of contacts downloaded.

Command		Operation
●	Call	Downloaded mobile phone contacts is displayed on the screen, and afterwards, you can make a call by speaking the name.
●	Call <Name>	You can immediately make a call to (name) in the downloaded mobile phone contacts. Ex.) "Call John Smith"
●	Call <Name> on mobile	You can immediately make a call to (name) in the downloaded mobile phone contacts saved as 'mobile'. Ex) "Call John Smith on mobile"
●	Call <Name> at Work (Call <Name> in office)	You can immediately make a call to (name) in the downloaded mobile phone contacts saved as 'Office'. Ex.) "Call John Smith in office"
●	Call <Name> at home	You can immediately make a call to (name) in the downloaded mobile phone contacts saved as 'home'. Ex) "Call John Smith at home"
●	Call <Name> on other (Call <Name> on other number)	You can immediately make a call to (name) in the downloaded mobile phone contacts saved as another phone category except 'mobile, home, office'. Ex) "Call John Smith on other"
●	Dial number	Displays a screen where you can say a phone number to dial.
●	Dial <Phone #>	You can make a call by directly speaking the number you want to call. Ex) Dial 123-456-7890 : "Dial one two three four five six seven eight nine zero"
●	Change Bluetooth device	It can disconnect from the Bluetooth device currently connected and connect to other Bluetooth devices already paired.



Navigation commands

Check the following before you use navigation commands:

- Search for and find addresses located in the state or province your car is currently in.
- If you want to search in another state, say the name of state/province and then say the address.
- Searches are sorted by city/province for quick search.
- Some commands are available only when the destination is fixed.

Command		Operation
●	Saved places	Moves to the traffic Information menu screen.
●	Traffic information	Moves to the traffic Information menu screen.
●	Go home	Set your home as the destination. Your home address must be set up in the navigation system.
●	Change home	Changes location for home.
●	Go to work	Set the destination to your office/place of work. Your office/place of work must be set up in the navigation system.
●	Change work	Changes location for work.
●	Previous destinations	Displays a list of recent destinations and you can set a destination by saying the number on the list.
●	Cancel route	Cancels the route to the fixed destination and exits guidance.
●	Pause route	Pauses the route guidance.
●	Route options	Moves to the route options screen.
●	Reroute	Restarts the route guidance.
●	Destination information	Tells you the remaining distance and time to your destination.
●	Route Overview (Show Route)	Displays a map overview of the entire route to your destination.
●	Previous Searches	Displays a list of previous searched points.

List of nearest locations

Navigation location names may be changed after a software update.



USING REAR VIEW MONITOR(RVM) - OPTION

ABOUT RVM

- Rear camera is an option for the customers who selected the option.
- In this instrument, for the safety of the user, the rear view monitor that can secure the rear view during the backward driving is connected.
- After the vehicle is started, if the transmission lever is put to "R", the rear view monitor starts the operation.

OPERATING RVM

When the vehicle is started, put the transmission lever to "R" position.

NOTE

- The rear camera has a wide angle lens to provide a wide view, so the distance shown on the screen differs from the actual distance.
- For your safety, always check the rear, left and right views when reversing.

USING SURROUND VIEW MONITOR(SVM) - OPTION

ABOUT SVM

- SVM is an option that is provided to the customers who selected the option.
- While vehicle is started, if gear is put to "R" position, it automatically starts SVM.
- If gear is changed from "R" to "P" position, SVM operation stops.

OPERATING FRONT SVM

After starting the vehicle, if you press camera view button after putting gear to "N" or "D". The front SVM starts.

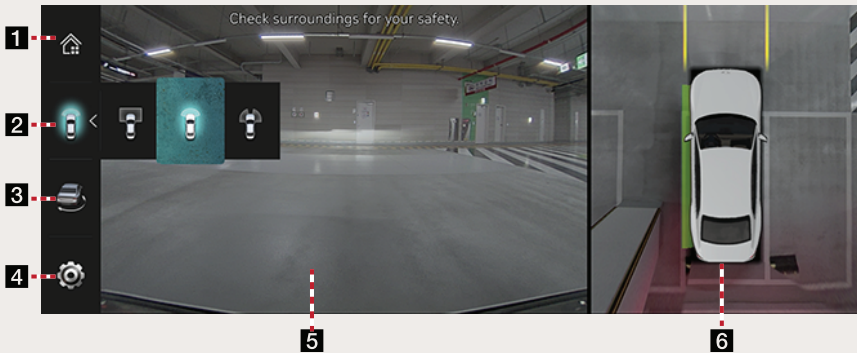

1 Home screen

Moves to the home screen.

2 Front top view

Displays an enlarged top view of the front.

Front wide view

Only front screen of the vehicle is displayed.

Front side view

Displays left front/right front screen of the vehicle simultaneously.



3 3D surround view

Displays 3D screen around the vehicle.

4 SVM settings

Move to SVM settings screen.

5 Front camera screen

Displays front camera view.

6 Top view camera screen

Displays top view that combines front, rear, left/right camera images.

! NOTE

- While front SVM is running, if you drive at about 10 km/h or more, SVM is turned off.
- At this state, even if you drive at about 10 km/h or less, SVM is remained at off state.

OPERATING REAR SVM

After starting the vehicle, if you put gear at "R" position. The rear SVM starts.

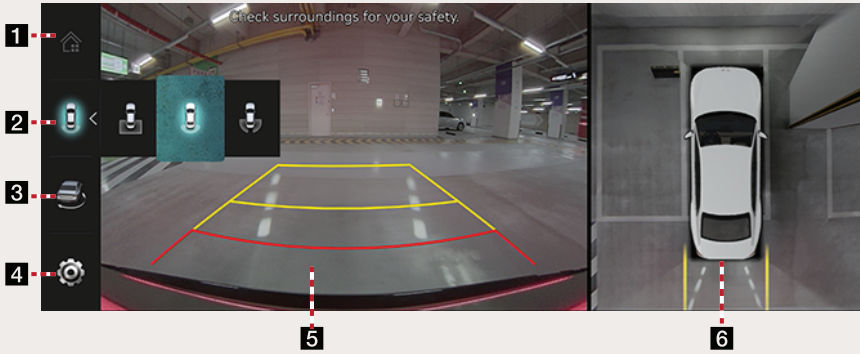

1 Home screen

Moves to the home screen.

2 Rear top view

Displays an enlarged top view of the rear.

Rear wide view

Displays only the rear screen of the vehicle.

Rear side view

Displays left rear/right rear screen of the vehicle simultaneously.

3 3D surround view

Displays 3D screen around the vehicle.

4 SVM settings

Move to SVM settings screen.

5 Rear camera screen

Displays rear view through the rear camera.

6 Top view camera screen

Displays top view that combines front, rear, left/right camera images.



 **NOTE**

- SVM camera has an optical lens to secure wide view, so there is a little difference between the distance shown on the screen and the actual one.
- For safety, make sure to check the rear, left, and right view by yourself.

CAMERA SETTINGS

Press [⚙️] on the SVM screen. Sets the properties of camera.

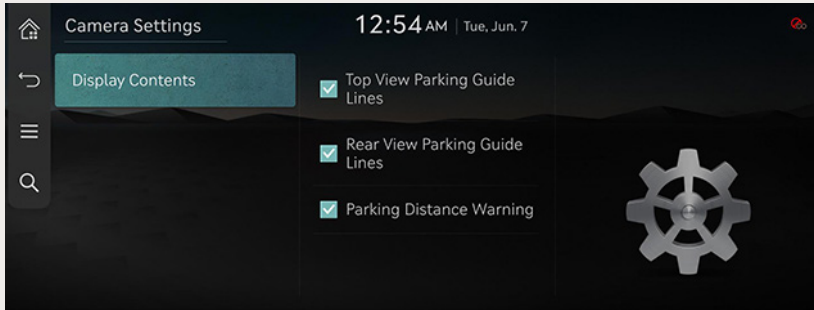

VIEWING CAMERA ON THE REAR SEAT

1. Press [Camera] on the rear seat display. The camera view is displayed.



2. Press [📺] repeatedly to change the camera view in sequence of front > rear > side > front.

WARNING DISPLAY

A warning icon is displayed on the screen when the vehicle door or trunk is opened, or the side mirrors are folded.

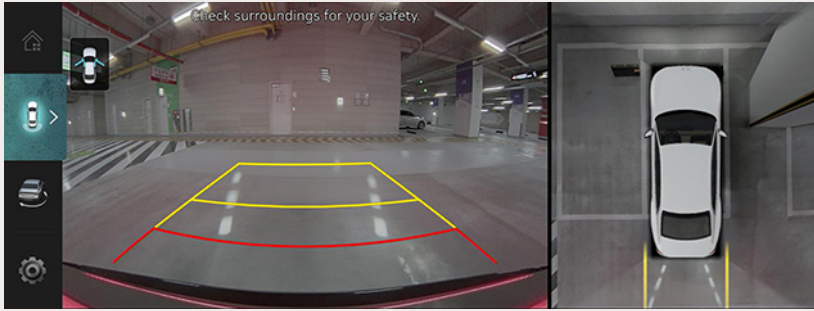

CLIMATE

The images displayed on this system may differ from actual ones.

OPERATING CLIMATE

Press [Climate] on the home screen.



1

Moves to the home screen.



Moves to the home screen or a previous screen.



Displays climate menu.

2 **Front seat set temperature**

Sets the set temperature of the front seat.

3 **Air clean mode**

The color is changed according to the air quality and condition inside the vehicle.

4 **Outside temperature**

Displays the current temperature outside the vehicle.

5 Activate upon Washer Fluid Use

Automatically prevents the washer fluid scent from entering the cabin.

When Entering Tunnels

Blocks outside air automatically when entering a tunnel.

Poor Air Quality Area

Blocks outside air automatically in locations where external air shut-off is recommended.

Smart Ventilation

When the climate control system is off, fresh air ventilation is activated automatically to maintain good cabin air quality.

Automatic Dehumidify

Automatically switches to fresh air ventilation to decrease humidity after an extended use of recirculated air.

Defog/Defrost

Sets the function used to reduce moisture on the windshield glass.

Auto Defog

Auto-activates various defog functions based on the level of humidity in the vehicle cabin.

Air Conditioner Auto-Dry

Turns on the fan to dry the inside of the air conditioner after the vehicle is turned off.

Climate Ctrl ECO Mode

Increases range of travel by reducing climate control cooling/heating power.

Driver Seat Warmer/Ventilation

Driver seat warmer/ventilation adjusts automatically based on climate control settings.

Steering Wheel Warmer

Steering wheel warmer adjusts automatically based on climate control settings.

6 Blower position

Changes the seat blower position to up/down.



7 AUTO

The air cooling and heating are automatically activated according to the set temperature.

A/C

When the A/C is active, air conditioner is operated for vehicle cooling.

HEAT

Turns the heater on and off.

DRIVER ONLY

Only the driver's seat activates the climate mode.

OFF

Turns off the climate function.

Blower level

Displays the set blower level.

SYNC

When the SYNC is active, passenger seat and driver seat are synchronized.

8 Rear Climate

You can set the rear seat climate controls.

OPERATING REAR CLIMATE

Controls the climate of the rear seat.

Press [Rear Climate] on the front climate screen.

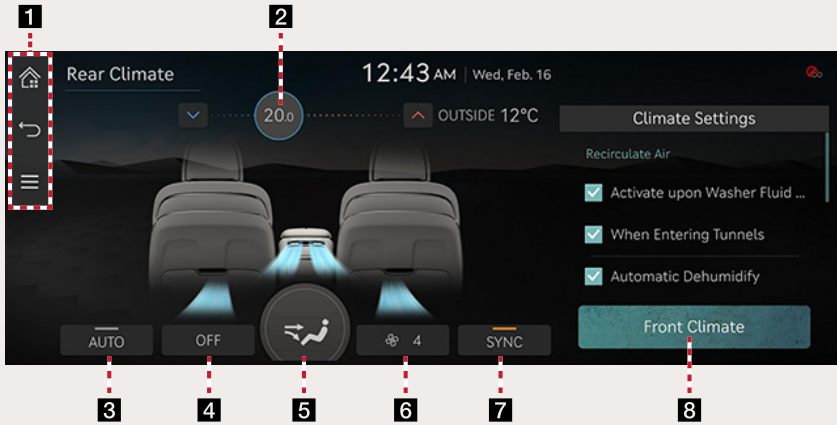

1

Moves to the home screen.



It moves to the home screen or a previous screen.



It displays climate menu.

2 **Rear Seat Set Temperature**

You can set the temperature of the rear seat.

3 **AUTO**

The air cooling and heating are automatically activated according to the set temperature.

4 **OFF**

Turns off the climate function.



5 Blower Position

Changes the seat blower position to up/down.

6 Blower Level

Sets the blower level.

7 SYNC

When the SYNC is active, front seat temperature is synchronized as the rear seat temperature.

8 Front Climate

You can set the front seat climate controls.

QUIET MODE

In quiet mode, radio/media is played only in the front seats.

Volume of the front seats is reduced to a level that can maintain quietness.

Press [Quiet Mode] on the home screen.

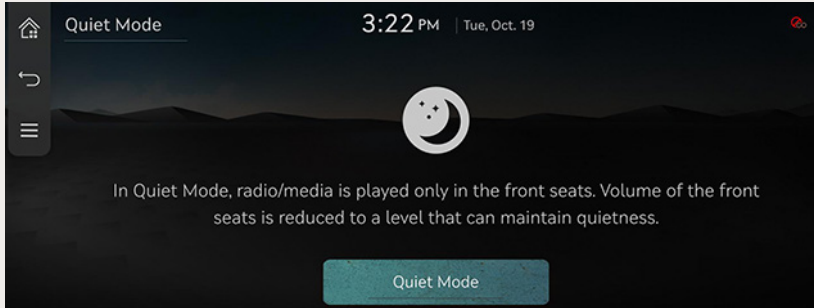

MANUAL

ONLINE MANUAL (NAVIGATION SYSTEM)

You can see web manual through QR code.

1. Press [Manual] > [Online Manual (Navigation System)] on the home screen.

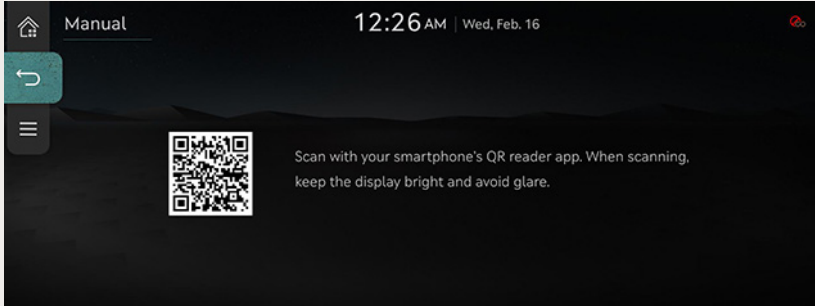

2. Scan QR code with mobile device.
3. For precise scan, avoid reflecting light, and maintain bright screen.

VEHICLE QUICK GUIDE

Quick guide may not include information which the user drives.

For more details, refer to the owner's manual.

Press [Manual] > [Vehicle Quick Guide] on the home screen.

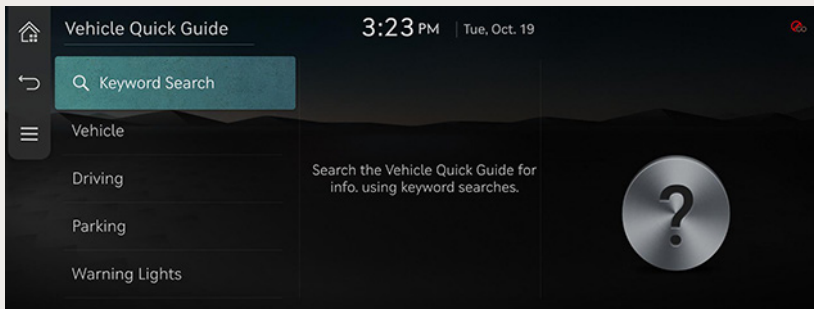

HANDWRITING MANUAL

Checks how to use the touch pad handwriting recognition and how to set the touch pad recognition angle.

Press [Manual] > [Handwriting Manual] on the home screen.

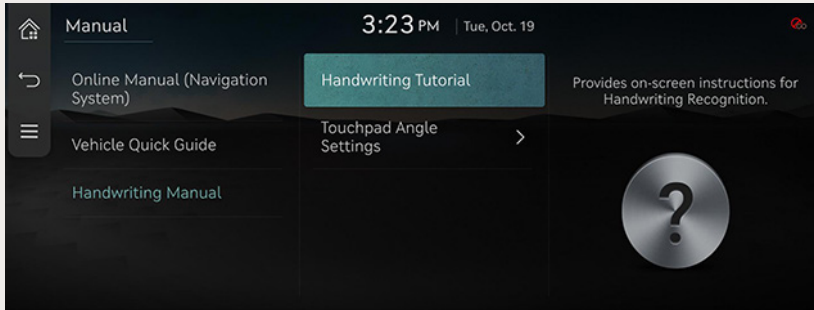

SEAT

Adjusts the seat position and angle to feel comfortable for the user.

1. Press [Seat] on the home screen,

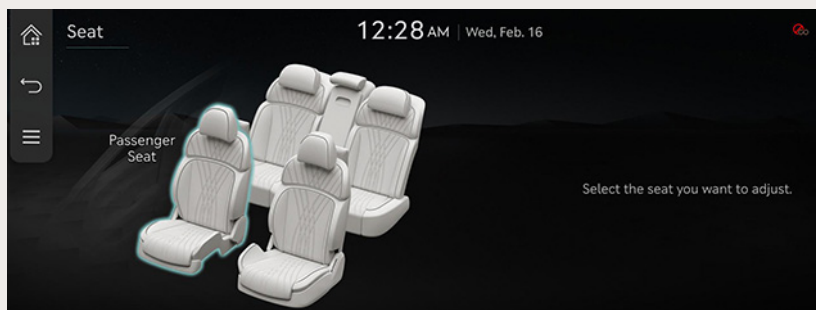

2. Adjust the desired items.

NOTIFICATION

Checks the notification by Genesis connected services center.

Provides vehicle related information and navigation updates.

Press [Notifications] on the home screen.

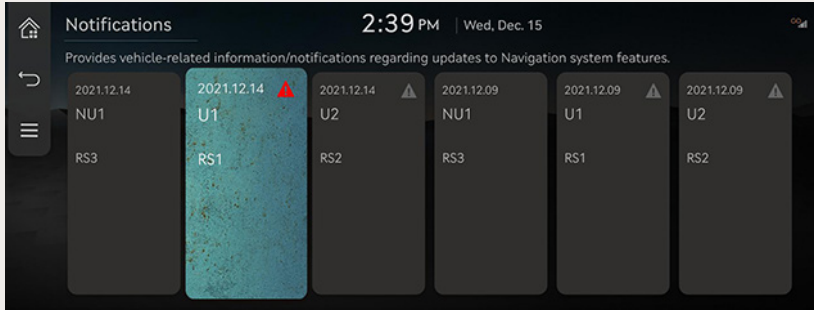

! NOTE

- You must activate to the Genesis connected services to use this function.
- Up to 100 notifications can be saved.

VALET MODE

videopage010

For privacy, disable the operation via the monitor or button when the valet mode is set. You can check the vehicle information through a smart phone application.

1. Press [Valet Mode] on the home screen.
2. Enter 4 new password to start valet mode.

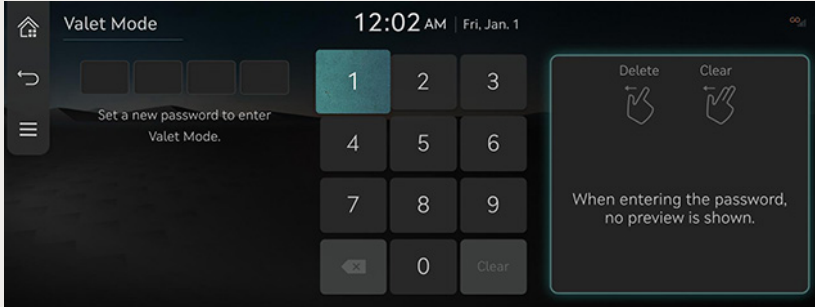

3. Enter the same password again.
4. When the valet mode is set, you can check the vehicle information in the smart phone application.
5. You can enter the four digits of the password you used to set the valet mode, or you can turn it off through the smart phone application.
6. If you fail to enter the password five times, you can only unlock it through the services center or the smart phone application.

! NOTE

- You must activate to the Genesis connected services to use this function.
- After signing up for the service, you need to install the Genesis connected services application on your smart phone.

3D SETUP

You can view the 3D vehicle image and enter the desired settings screen on the screen. Press [3D Setup] on the home screen.

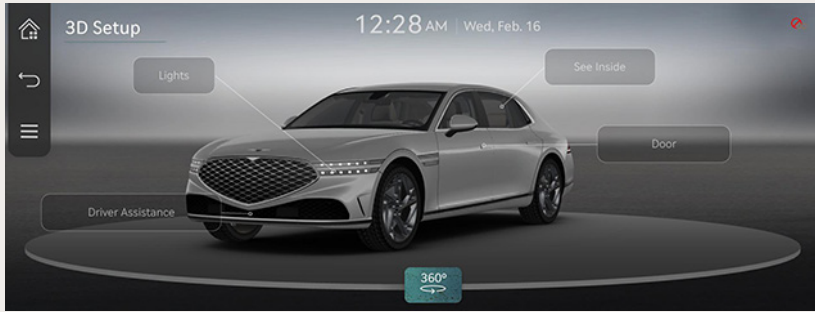

CLUSTER

SWITCHING GAUGE

The cluster style can be switched with two gauge.

You can change it by pressing the tumbler button on the left side of the steering wheel.

Digital Gauge

Displays the cluster in digital style.

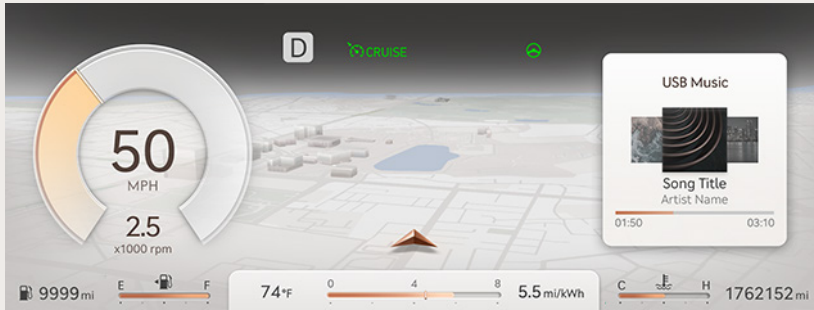

Analog Gauge

Displays the cluster in an analog way.

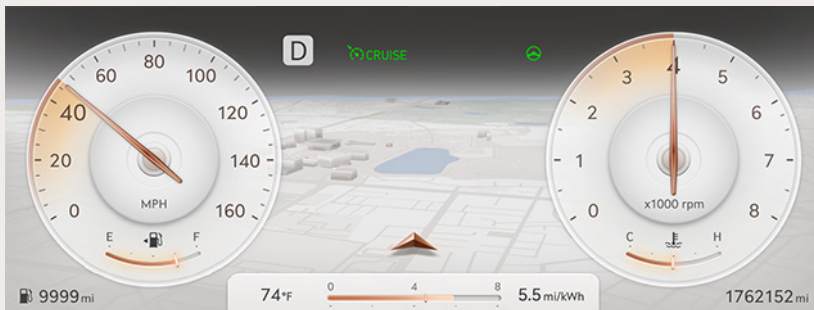

SWITCHING VIEW MODE

Each view mode can be changed by pressing the center of the tumbler button on the left side of the steering wheel.

In case of digital gauge

- Map view mode: Displays navigation directions in neon view. (If the navigation specification is equipped)
- Assist view mode: Displays driving comfort and driving safety-related status on the screen. (If the driver assistance function is equipped)
- AR view mode: Displays navigation directions in AR mode. (If the augmented reality specification is equipped)
- Normal view mode : Display various widgets in the center of the screen.

In case of analog gauge

- Map view mode: Displays navigation directions in neon view. (If the navigation specification is equipped)
- Assist view mode: Displays driving comfort and driving safety-related status on the screen. (If the driver assistance function is equipped)
- AR view mode: Displays navigation directions in AR mode. (If the augmented reality specification is equipped)
- Normal view mode : Display various widgets on the right side of the screen. In the center of the screen, you can check the trip computer information.

NOTE

For specifications without navigation or augmented reality navigation, map view mode and AR view mode are not supported.

CLUSTER WIDGET

- The cluster widget is displayed on the right side of the cluster screen.
- You can access the cluster widget by pressing the optical mouse on the right side of the steering wheel remote control.
- To navigate the widget menu, swipe the optical mouse in browse mode and then press the button to select.

! NOTE

- You can not use cluster widget while setting Display-Theme/Screen Composition Settings-Widget in AVN settings menu.
- The voice recognition widget is not displayed in the cluster when voice recognition is turned on in Vehicle-Head-Up Display-Display Information in AVN settings menu. (You must unmark the function of HUD in AVN to show it in the cluster.)

WARNING LIGHT

This is the warning light displayed on the cluster. For details, refer to the vehicle instruction manual.

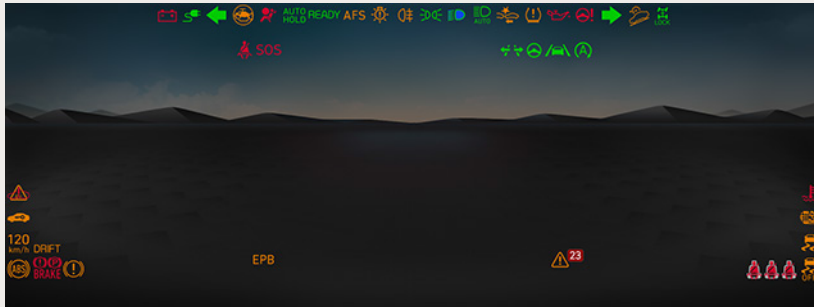

HUD (HEAD-UP DISPLAY)

The images displayed on this system may differ from actual ones.

SETTINGS HUD VIEW

When [Enable head-up display] is checked in the head-up display settings screen of the vehicle settings, the HUD screen is displayed on the driver's windshield.

SETTINGS HUD DISPLAY INFORMATION

1. On the vehicle settings screen, press [Head-Up Display] > [Content Selection].

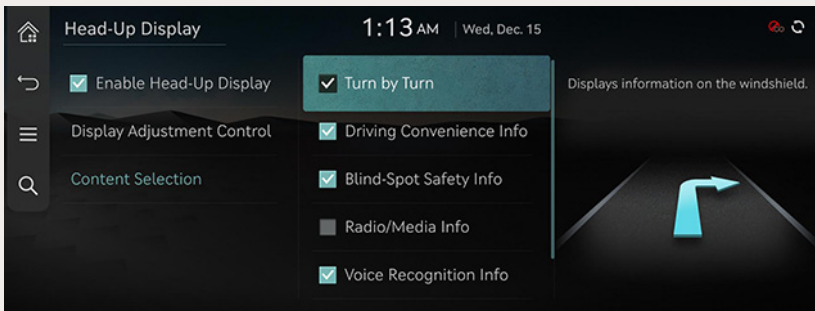

2. Press the desired item.
 - [Turn by Turn]: Displays information about navigation route guidance. It is displayed when setting a destination and guiding a route.
 - [Driving Convenience Info]: Displays information when driver assistance functions are activated.
 - [Blind-Spot Safety Info]: Displays warning when a risk is determined due to vehicle approaching from the rear.
 - [Radio/Media Info]: Displays information when changing radio frequencies or media files with the steering wheel. (including Bluetooth phone)
 - [Voice Recognition Info]: Displays information when activating voice recognition.

! NOTE

The HUD provides vehicle speed information, parking information, speed and sign/camera information, and driver assistance emergency alerts.

BLUETOOTH HEADPHONES

The rear seat passenger can listening to audio by pairing Bluetooth headphones to the vehicle. Only one device can be connected, and will support Bluetooth Audio only.

HEADPHONE CONNECTION (IF EQUIPPED)

1. Press [Bluetooth Headphones] on the rear seat display.

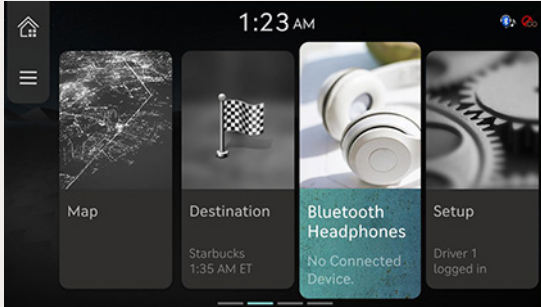

2. Press [Add] > [Search] on the headphone connection screen.

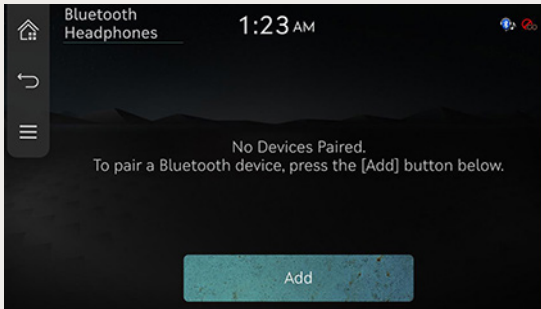

3. Selects a device to connect on the searched list.

MOOD CURATOR (IF EQUIPPED)

The combination of systems provides 4 moods that stimulate the senses and help improve emotions.

OPERATING MOOD CURATOR

Press [Mood Curator] on the home screen.

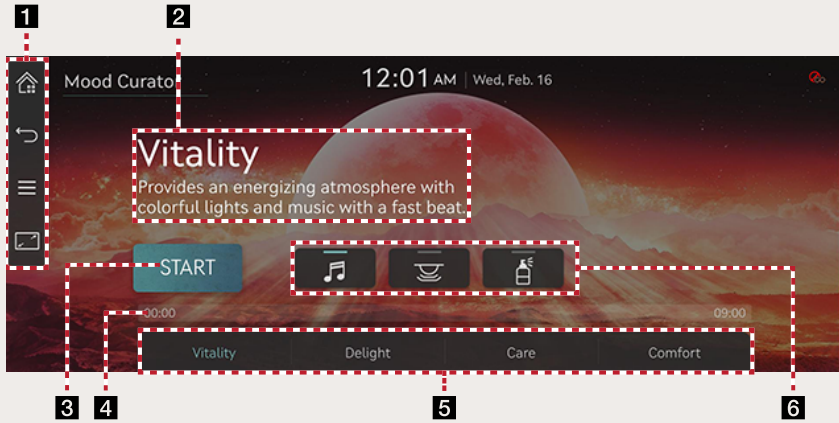

1

Moves to the home screen.



It moves to the home screen or a previous screen.



It displays mood curator menu.



Displays background image only.

2 **Mode Information**

Displays current mode information.

3 **Start/Stop**

Press to start or stop the mood curator.

4 **Playback progress bar**

Displays the playback progressing information.

5 Mode List

You can select a desired mode and displays currently playing mode.

6

Select whether to play music in the current mode.



Select whether to play interior mood light in the current mode.



Set whether to play scent diffusion in the current mode.

REFERENCE



THE INFORMATION ABOUT A OWNER'S MANUAL

ABOUT THIS OWNER'S MANUAL

Before use, please be sure to read precautions for safety and use it properly.

This owner's manual presents warning, caution and reference about the case that a driver or other person can be injured and its response to the case.

Be sure to read and observe this content since it is a very important point related to safety.

Please note that the vehicle model shown in the video manual may differ from your vehicle.

THE SYMBOL USED IN THIS OWNER'S MANUAL

WARNING

A symbol about issues that may lead to serious injury and accident related to life if the warnings described in this owner's manual are not observed.

CAUTION



A symbol about issues that may lead to an accident and bring injury or cause damage or failure of a car if the cautions described in this owner's manual are not observed.

NOTE

- Explanation about detailed information to understand the right use of product and its function.
- Explanation about related terms in case of explaining its function.

PRECAUTIONS FOR SAFETY

NOTATIONS USED WITHIN THIS USER'S MANUAL

	<div style="border: 1px solid black; padding: 5px;"> <p>CAUTION</p> <p>RISK OF ELECTRIC SHOCK DO NOT OPEN</p> </div>	
<p>CAUTION: TO REDUCE THE RISK OF ELECTRIC SHOCK, DO NOT REMOVE THE COVER (OR BACK). NO USER SERVICEABLE PARTS INSIDE. REFER SERVICING TO QUALIFIED SERVICE PERSONNEL.</p>		



The lightning flash with the arrowhead symbol within an equilateral triangle is intended to alert the user about the presence of uninsulated dangerous voltage within the product's enclosure that may be of sufficient magnitude to constitute a risk of electric shock.



The exclamation point within an equilateral triangle is intended to alert the user to the presence of important operating and maintenance (servicing) instructions in the literature accompanying the appliance.



Always operate the vehicle in a safe manner. Do not become distracted by the vehicle while driving and always be fully aware of all driving conditions. Do not change settings or any functions. Pull over in a safe and legal manner before attempting such operations.

To promote safety, certain functions are disabled unless the parking brake is on.



To reduce the risk of electric shock, do not remove the cover or back of this product. There are no user-serviceable parts inside. Refer servicing to qualified service personnel.



To reduce the risk of fire or electric shock, do not expose this product to dripping or splashing water, rain, or moisture.



When driving your vehicle, be sure to keep the volume of the unit low enough to allow you to hear sounds coming from the outside.



Do not drop it and avoid heavy impacts at anytime.



The driver should not watch the monitor while driving. If the driver watches the monitor while driving, it may lead to carelessness and cause an accident.

**WARNING:**

- Don't use a cellular phone when you are driving. You must stop at a safe place to use a cellular phone.
- The use of the navigation radio by no means relieves the driver of his/her responsibilities. The highway code must always be observed. Always observe the current traffic situation.
- The applicable traffic regulations and the prevailing traffic situation always take precedence over the instructions issued by the navigation system if they contradict one another.
- For traffic safety reasons, use the navigation system menus only before starting a journey or when the vehicle is stationary.
- In certain areas, one-way streets and turn off and entry prohibitions (e.g. pedestrian zones) are not recorded. In areas such as these the navigation system will issue a warning. Pay particular attention to one-way streets and turn off and entry restrictions.
- The navigation system does not take the relative safety of the suggested routes into consideration. Road blocks, building sites, height or weight restrictions, traffic or weather conditions or other influences which affect the route safety or travel time are not taken into consideration for the suggested routes. Use your own discretion in order to decide on the suitability of the suggested routes.
- The current legal road traffic speed limit always takes priority over the values saved on the data. It is impossible to provide an assurance that the speed values of the navigation system will always match those of the current traffic regulations in every situation.
- Always observe the applicable legal speed limits the traffic regulations. The vehicle speedometer must always be given priority for display of the vehicle speed.
- Do not rely exclusively on the navigation system when attempting to locate an emergency service (hospital, fire service etc.). It cannot be guaranteed that all available emergency services in your vicinity are saved in the database. Use your own discretion and abilities to secure help in such situations.



CAUTION:

- Do not keep the navigation system running with the engine stopped. Doing so may discharge the vehicle battery. When you use the navigation system, always keep the engine running.
- When the driver wants to operate the navigation system, first park the vehicle in a safe location and set the parking brake. Operating the system while driving can distract the driver and may result in a serious accident.
- Do not disassemble or modify this system. If you do, it may result in accidents, fire, or electrical shock.
- Some states/provinces may have laws limiting the use of video screens while driving. Use the system only where it is legal to do so.
- Do not use your phone in private mode when you are driving. You must stop at a safe location to use it.



FCC NOTICE (FOR USA)

This equipment has been tested and found to comply with the limits for a Class B digital device, pursuant to Part 15 of the FCC Rules. These limits are designed to provide reasonable protection against harmful interference in a residential installation. This equipment generates, uses, and can radiate radio frequency energy and, if not installed and used in accordance with the instructions, may cause harmful interference to radio communications. However, there is no guarantee that interference will not occur in a particular installation. If this equipment does cause harmful interference to radio or television reception, which can be determined by turning the equipment off and on, the user is encouraged to try to correct the interference by one or more of the following measures:

- Reorient or relocate the receiving antenna.
- Increase the separation between the equipment and the receiver.
- Connect the equipment to an outlet on a circuit different from that to which the receiver is connected.
- Consult the dealer or an experienced radio/TV technician for help.

This device complies with part 15 of the FCC Rules. Operation is subject to the following two conditions:

- (1) this device may not cause harmful interference and
- (2) this device must accept any interference received, including interference that may cause undesired operation. Any changes or modifications in construction of this device which are not expressly approved by the party responsible for compliance could void the user's authority to operate the equipment.

FCC RADIO FREQUENCY INTERFERENCE REQUIREMENTS (FOR UNII DEVICES)

High power radars are allocated as primary users of the 5.25 to 5.35 GHz and 5.65 to 5.85 GHz bands. These radar stations can cause interference with and/or damage this device. This device cannot be co-located with any other transmitter.

FCC RF RADIATION EXPOSURE STATEMENT

[For having wireless function (WLAN, Bluetooth,...)]

This equipment complies with FCC radiation exposure limits set forth for an uncontrolled environment. This transmitter must not be co-located or operating in conjunction with any other antenna or transmitter.

This equipment should be installed and operated with minimum distance 20 cm (7.8 inches) between the antenna and your body. Users must follow the specific operating instructions for satisfying RF exposure compliance.



INDUSTRY CANADA STATEMENT

[For having wireless function (WLAN, Bluetooth,...)]

This device contains licence-exempt transmitter(s)/receiver(s) that comply with Innovation, Science and Economic Development Canada's licence-exempt RSS(s). Operation is subject to the following two conditions:

- (1) This device may not cause interference.
- (2) This device must accept any interference, including interference that may cause undesired operation of the device.

IC RADIATION EXPOSURE STATEMENT

[For having wireless function (WLAN, Bluetooth,...)]

This equipment complies with IC radiation exposure limits set forth for an uncontrolled environment. This equipment should be installed and operated with minimum distance 20 cm (7.8 inches) between the antenna & your body.

NOTE: THE MANUFACTURER IS NOT RESPONSIBLE FOR ANY RADIO OR TV INTERFERENCE CAUSED BY UNAUTHORIZED MODIFICATIONS TO THIS EQUIPMENT. SUCH MODIFICATIONS COULD VOID THE USER'S AUTHORITY TO OPERATE THE EQUIPMENT.

RSS-247 REQUIREMENT (FOR CANADA)

[For product having the wireless function using 5 GHz frequency bands]

- i. the device for operation in the band 5150-5250 MHz is only for indoor use to reduce the potential for harmful interference to co-channel mobile satellite systems;
- ii. for devices with detachable antenna(s), the maximum antenna gain permitted for devices in the bands 5250-5350 MHz and 5470-5725 MHz shall be such that the equipment still complies with the e.i.r.p. limit;
- iii. for devices with detachable antenna(s), the maximum antenna gain permitted for devices in the band 5725-5850 MHz shall be such that the equipment still complies with the e.i.r.p. limits as appropriate; and
- iv. [for devices operating in the band 5250-5350 MHz having an e.i.r.p. greater than 200 mW] antenna type(s), antenna models(s), and worst-case tilt angle(s) necessary to remain compliant with the e.i.r.p. elevation mask requirement set forth in section 6.2.2.3 of RSS-247 shall be clearly indicated.

Users should also be advised that high-power radars are allocated as primary users (i.e. priority users) of the bands 5250-5350 MHz and 5650-5850 MHz and that these radars could cause interference and/or damage to LE-LAN devices.

GENERAL INFORMATION

CAUTIONS FOR THE USE OF USB

- Please use it by installing a USB device after starting an engine.
- If the engine is started with a USB device installed, a USB device can be damaged.
- If it is not a standard format file, it is not played.
- MP3/WMA file only supports a music file with a compression level of 8 Kbps to 320 Kbps.
- Be careful of static electricity when connecting and disconnecting a USB external device.
- If encrypted MP3 player is connected to an external USB device, it is not recognized.
- When connecting a USB external device, it may not be recognized depending on the condition of a USB external device.
- It supports FAT16, FAT32, exFAT and NTFS.
- Some USB devices may not be supported due to compatibility issue.
- Please do not allow human body or object to touch the USB connection.
- Connecting and disconnecting a USB device for a short time repeatedly can cause its failure.
- Please connect and disconnect a USB external device only with the audio power turned off.
- The recognition time can vary depending on the type, capacity and format of a stored file but it is not a product failure.
- When using separate devices like USB HUB and extension cables, the USB may not be recognized. So, please use it by directly connecting to an infotainment system port of a car.
- When uploading an application program in a specific USB, the file may not be played.
- When the USB device, that is not recognized as removable discs like MP3 Player, mobile phone and digital camera, was connected, it may not be operated properly.
- The charge through USB may not be supported in case of some mobile devices.
- No operation may be guaranteed except standard product (Metal Cover Type) USB memory
- The operation of HDD Type, CF and SD memory is not guaranteed.
- The file that applied DRM (Digital Rights Management) is not played.
- The USB memory stick (SD Type or CF Type) used by being inserted into an adapter may not be recognized.

PLAYABLE FILE STANDARD

MUSIC FILE INFORMATION

- Playable File Types: “.mp3”, “.wma”, “.mka”, “.wav”, “.flac”, “.ogg”, “.ac3”, “.dts”, “.m4a”
- Playable Codec Types: “MPEG-1 layer I, II, III”, “AC-3”, “AAC”, “WMA”, “PCM (WAV only)”, “ADPCM (WAV only)”, “DTS”, “FLAC”
- Sampling Frequency: 8 - 48 KHz (MP3), 22.5 - 96 KHz (WMA), 8 - 192 KHz (PCM/WAV), 8 - 44 KHz (ADPCM/WAV), 32, 33.1, 48 KHz (AC-3), 8 - 192 KHz (AAC), 8 - 192 KHz (FLAC), 8 - 192 KHz (DTS)
- Bit rate: 8 - 320 Kbps (MP3), 20 - 320 Kbps (WMA), 8 ~ 12.3Mbps (PCM/WAV), 8 ~ 352.8Kbps (ADPCM/WAV), 8 - 320Kbps (AC-3), 8 - 320 Kbps (AAC), 8~4.6Mbps (FLAC), 8 - 24.5 Mbps (DTS)

VIDEO FILE INFORMATION

- Playable File Types: “.avi”, “.mpg”, “.mpeg”, “.mp4”, “.asf”, “.wmv”, “.mkv”
- Playable Codec Types: “MPEG-1”, “MPEG-2 simple profile - main level”, “MPEG-2 main profile - low,main,high level”, “VC-1”, “AVC”, “H.263 profile 0 ~ profile2”, “MPEG4 v2,v3”
- Playable resolution and frame rate: (MPEG-1) within 1280 x 720 30fps, 720 x 480p 30fps / 720 x 576p 25fps (H.263), 1920 x 1080 30fps (other supported Codec format)
- Playable File Types: “.smi”, “.srt”
- When the file name of image and subtitles is different, subtitles may not be displayed.



BEFORE THINKING THE PRODUCT HAS MALFUNCTIONED

The current position as shown on the navigation may differ from the actual position under the following conditions.

The following occurrences are not malfunctions:

- When driving on Y-shaped roads with narrow angles the current position may be displayed in the opposite direction.
- Within city streets, the current position may be displayed on the opposite side or on an off-road position.
- When changing the zoom level from maximum to a different level, the current position may become displayed on a different road.
- If the vehicle is loaded onto a ferry or a car transport vehicle, the current position may become stalled on the last position prior to loading.
- When driving on a spiral-shaped road.
- When driving in mountain regions with sharp turns or sudden brakes.
- When entering a road after passing an underground parking structure, building parking structure, or roads with many rotations.
- When driving in heavy traffic with frequent starts and stops.
- When driving under slippery conditions, such as heavy sand, snow, etc.
- When the tires have recently been replaced. (Especially upon use of spare or studless tires.)
- When using tires of improper size.
- When the tire pressure for the 4 tires are different.
- When the replacement tire is worn or used. (Especially studless tires having passed a second season.)
- When driving near high-rise buildings.
- When a roof carrier has been installed.
- When a long distance route is calculated while driving on an expressway, in such cases, continued driving will automatically enable the system to conduct map matching or use updated GPS information to provide the current position. (In such cases, up to several minutes may be required.)

Correct route guidance may not occur due to search conditions or driving position.

The following occurrences are not malfunctions:

- Guidance to go straight may be given while driving on a straight road.
- Guidance may not be given even when having turned at an intersection.
- There are certain intersections in which guidance may not occur.
- A route guidance signaling for a u-turn may occur in some No u-turn intersections.
- Route guidance signaling entrance into a No-entry zone may occur. (No-entry zone, road under construction, etc.)
- Guidance may be given to a position that is not the actual destination if roads to reach the actual destination do not exist or are too narrow.
- Faulty voice guidance may be given if the vehicle breaks away from the designated route. (e.g. if a turn is made at an intersection while the navigation provided guidance to go straight.)

These situations may occur after conducting route calculation.

The following occurrences are not malfunctions:

- Guidance may be given to a position differing from the current position when turning at an intersection.
- When driving in high speeds, route recalculation may take a longer period of time.
- Route guidance signaling for a u-turn may occur in some No u-turn intersections.
- Route guidance signaling entrance into No-entry zone may occur. (No-entry zone, road under construction, etc.)
- Guidance may be given to a position removed from the actual destination if roads to reach the actual destination do not exist or are too narrow.
- Faulty voice guidance may be given if the vehicle breaks away from the designated route. (e.g. If a turn is made at an intersection while the navigation provided guidance to go straight.)



BEFORE YOU THINK THE PRODUCT IS DEFECTIVE

1. Errors which occur during the operation or installation of the device may be mistaken as a malfunction of the actual device.
2. If you are having problems with the device, try the suggestions listed below.
3. If the problems persist, contact your dealer.

Problem: There are small red, blue, or green dots on the screen
Possible Cause : Because the LCD is manufactured with technology requiring high point density, a pixel or lighting deficiency may occur within 0,01% of total pixels.
Problem: The sound or image is not working
Possible Cause : <ul style="list-style-type: none"> - Has the switch for the vehicle been turned to [ACC] or [ON]? - Has the system been turned off?
Problem: The screen is being displayed but sound is not working
Possible Cause : <ul style="list-style-type: none"> - Has the volume been set to a low level? - Has the volume been muted?
Problem: When the power is turned on, the corners of the screen are dark
Possible Cause : <ul style="list-style-type: none"> - The display appearing somewhat dark after prolonged periods of use is normal with LCD panels. It is not a malfunction. - If the screen is very dark, contact your nearest dealer for assistance.
Problem: Sound is working from only one speaker
Possible Cause : Are the positions of fader or balance sound controls adjusted to only one side?
Problem: The external device is not working
Possible Cause : Is the external device connected with a standard connector cable?
Problem: When turning power on, the most recent mode screen is not displayed
Possible Cause : <ul style="list-style-type: none"> - Within modes that play files by reading external sources, such as USB or Bluetooth® streaming mode, the most recently played mode screen prior to turning off power may not properly load. - If there is no the corresponding device is not connected, the mode operated prior to the most recent mode will operate. - If the previous mode still cannot be properly played, the mode operated prior to that will operate.



TROUBLESHOOTING

Problem: The power does not turn on.
<ul style="list-style-type: none"> • Possible Cause : The fuse is disconnected. • Countermeasure: <ul style="list-style-type: none"> - Replace with a suitable fuse. - If the fuse is disconnected again, please contact your dealer.
<ul style="list-style-type: none"> • Possible Cause : Device is not properly connected. • Countermeasure: Check to see that the device has been properly connected.
Problem: The system does not play.
<ul style="list-style-type: none"> • Possible Cause : The vehicle battery is low. • Countermeasure: Charge the battery if the problem persists, contact your point of purchase or service center.
Problem: The video color/tone quality is low.
<ul style="list-style-type: none"> • Possible Cause : The brightness, saturation, and contrast levels are not set properly. • Countermeasure: Properly adjust the brightness, saturation, and contrast levels through the display settings.
Problem: Sound does not work.
<ul style="list-style-type: none"> • Possible Cause : The volume level is set to the lowest level. • Countermeasure: Adjust the volume level.
<ul style="list-style-type: none"> • Possible Cause : The connection is not proper. • Countermeasure: Check to see that the device has been properly connected.
<ul style="list-style-type: none"> • Possible Cause : The device is currently fast-forwarding, rewinding, scanning, or playing in slow mode. • Countermeasure: The sound will not work when the device is fast-forwarding, rewinding, scanning, or playing in slow mode.
Problem: The sound or video quality is low.
<ul style="list-style-type: none"> • Possible Cause : Vibration is occurring from where the conversion switch has been installed. • Countermeasure: The sound may be short circuited and the video distorted if the device vibrates.



Problem: The USB does not work
<ul style="list-style-type: none"> • Possible Cause : USB memory is damaged. • Countermeasure: Please use after formatting the USB into FAT 16/32, exFAT, NTFS format.
<ul style="list-style-type: none"> • Possible Cause: USB memory has been contaminated. • Countermeasure: Remove any foreign substances on the contact surface of the USB memory and infotainment system.
<ul style="list-style-type: none"> • Possible Cause: A separately purchased USB HUB is being used. • Countermeasure: Directly connect the USB memory with the infotainment system on the vehicle.
<ul style="list-style-type: none"> • Possible Cause: A USB extension cable is being used. • Countermeasure: Directly connect the USB memory with the infotainment system on the vehicle.
<ul style="list-style-type: none"> • Possible Cause : A USB which is not a Metal Cover Type USB Memory is being used. • Countermeasure: Use standard USB Memory.
<ul style="list-style-type: none"> • Possible Cause : An HDD type, CF, SD Memory is being used. • Countermeasure: Use standard USB Memory.
<ul style="list-style-type: none"> • Possible Cause : There are no music files which can be played. • Countermeasure: Only MP3, WMA file formats are supported. Please use only the supported music file formats.

TRADEMARKS AND LICENSES

TRADE MARKS

DOLBY



DOLBY AUDIO

The product is produced under the license of Dolby Laboratories.

“Dolby” and the Double “D” signs are the trademarks of Dolby Laboratories.

DTS 2.0



For DTS patents, see <http://patents.dts.com>.

Manufactured under license from DTS, Inc. DTS, the symbol, DTS and the Symbol together, and Digital Surround are registered trademarks or trademarks of DTS, Inc. in the United States and/or other countries.

© DTS, Inc. All Rights Reserved.

Bluetooth®



Bluetooth® word mark and logo is a registered trademark of Bluetooth SIG, Inc. and all the Bluetooth marks and logos are under the license.

In order to use Bluetooth wireless technology, a mobile phone, that Bluetooth function is supported, is required.

SiriusXM™



© 2021 Sirius XM Radio Inc. SiriusXM, Automatic, Pandora and all related logos are trademarks of Sirius XM Radio Inc. and its respective subsidiaries. All rights reserved.

HD Radio™



HD Radio Technology manufactured under license from iBiquity Digital Corporation. U.S. and Foreign Patents. For patents see <http://dts.com/patents>.

HD Radio, Artist Experience, and the HD, HD Radio, and "ARC" logos are registered trademarks or trademarks of iBiquity Digital Corporation in the United States and/or other countries.



NAVIGATION

END USER LICENSE AGREEMENT

PLEASE READ THIS END USER LICENSE AGREEMENT ("EULA") CAREFULLY BEFORE USING THE NAVIGATION SYSTEM.

This is a license agreement between you and Hyundai Autoever, CORP. including its affiliates ("COMPANY") regarding a copy of COMPANY navigable map database together with associated software, media and explanatory printed documentation published by COMPANY (jointly the "Product").

The Product is provided for your personal, internal use only and not for resale.

It is protected by copyright and is subject to the following terms which are agreed to by you, on the one hand, and COMPANY and its licensors (and their licensors and suppliers) (collectively, "Licensors") on the other hand.

By using the Product, you accept and agree to all terms and conditions in this End User License Agreement ("EULA").

IF YOU DO NOT AGREE TO THE TERMS OF THIS EULA, YOU MUST PROMPTLY EXIT THE PRODUCT OPERATION PROGRAM AND DO NOT USE OR ACCESS TO THE PRODUCT.

You agree that your rights under this EULA may be terminated automatically without notice if you fail to comply with any term(s) of this EULA.



Terms and Conditions

Personal Use Only.

You agree to use this Product together with COMPANY authorized application for the solely personal, non-commercial purposes for which you were licensed, and not for service bureau, time-sharing or other similar purposes.

Accordingly, but subject to the restrictions set forth in the following paragraphs, you agree not to otherwise reproduce, copy, modify, decompile, disassemble, create any derivative works of, or reverse engineer any portion of this Data, and may not transfer or distribute it in any form, for any purpose, except to the extent permitted by mandatory laws.

You may not assign this EULA or any of the rights or licenses granted under this EULA, except when installed in the system for which it was created.

Restrictions.

Except where you have been specifically licensed to do so by COMPANY, and without limiting the preceding paragraph, you may not use the Product (i) with any products, systems, or applications installed or otherwise connected to or in communication with vehicles, capable of vehicle navigation, positioning, dispatch, real time route guidance, fleet management or similar applications; or (ii) with or in communication with any positioning devices or any mobile or wireless-connected electronic or computer devices, including without limitation cellular phones, palmtop and handheld computers, pagers, and personal digital assistants or PDAs.

COPYING OR USE OF THE PRODUCT EXCEPT AS PERMITTED BY THIS EULA IS UNAUTHORIZED AND IS COPYRIGHT INFRINGEMENT UNDER THE LAWS OF YOUR COUNTRY. IF YOU COPY OR USE THE PRODUCT WITHOUT COMPANY PERMISSION, EXCEPT AS PERMITTED BY THIS EULA, YOU ARE VIOLATING THE LAW AND LIABLE TO COMPANY AND ITS LICENSORS FOR DAMAGES, AND YOU MAY BE SUBJECT TO CRIMINAL PENALTIES.

THE PRODUCT MAY INCLUDE ENFORCEMENT TECHNOLOGY DESIGNED TO PREVENT (i) UNAUTHORIZED COPYING OF THE PRODUCT ONTO PHYSICAL STORAGE MEDIA OR VIA TRANSFER OVER THE INTERNET OR OTHER ELECTRONIC COMMUNICATION MEANS AND/OR (ii) ILLEGAL USAGE OF THE PRODUCT OTHER THAN BY A SPECIFICALLY AUTHORIZED DEVICE. YOU AGREE THAT COMPANY MAY USE THESE MEASURES TO PROTECT COMPANY AND THE LICENSORS AGAINST COPYRIGHT INFRINGEMENT.

**Uploads.**

The Product may provide functionality through which you are able to upload certain information about your use of the Product (collectively, "Uploads") to COMPANY servers or receive other services from COMPANY (collectively, the "Services").

If you use such functionality, you authorize COMPANY to retain your Uploads on its servers. COMPANY will have no obligation to provide any Services, may change the form and nature of any Services at any time with or without notice to you, will have no liability whatsoever to you for any failure of the Product or Services to transmit your Uploads to or from COMPANY servers, may cease providing any Services at any time with or without notice to you, and will have no obligation to retain your Uploads (or any other materials you may provide to COMPANY) on its servers or return your Uploads (or any other materials you may provide to COMPANY) to you before deleting them from its servers.

Storage.

The Product may provide functionality through which you are able to store information (such as images) on the device on which you are using the Product.

COMPANY will have no liability whatsoever to you or any third party for any failure of the Product to store any such information on such device.

Personal Information.

By using the Product, you agree to the collection, retention and processing of your personal data (including the location of your mobile device) by COMPANY and to the storage and processing of such personal information on computers located outside of the country in which you reside.

Even though COMPANY has taken steps intended to protect your personal information from being intercepted, accessed, used, or disclosed by unauthorized persons, COMPANY cannot fully eliminate security risks associated with your personal information and cannot guarantee that its systems will not be breached.

See [*] for additional information regarding COMPANY's use of your personal information.

**Warning.**

The Product reflects reality as existing before you received the product and it comprises data and information from government other sources.

Accordingly, the product may contain inaccurate or incomplete information due to the passage of time, changing circumstances, sources used and the nature of collecting comprehensive geographic product, any of which may lead to incorrect results.

THE PRODUCT AND SERVICES MAY NOT TO BE USED FOR SAFETY OF LIFE APPLICATIONS, OR FOR ANY OTHER APPLICATION IN WHICH THE ACCURACY OR RELIABILITY OF THE PRODUCT OR SERVICES COULD CREATE A SITUATION WHERE PERSONAL INJURY OR DEATH MAY OCCUR.

DO NOT ATTEMPT TO CONFIGURE THE PRODUCT OR INPUT INFORMATION WHILE DRIVING. FAILURE TO PAY FULL ATTENTION TO THE OPERATION OF YOUR VEHICLE COULD RESULT IN DEATH, SERIOUS INJURY, OR PROPERTY DAMAGE.

BY USING THE PRODUCT, YOU ASSUME ALL RESPONSIBILITY AND RISK.

Disclaimer of Warranty.

The Product is provided to you "as is," and you agree to use it at your own risk.

SUBJECT TO THE APPLICABLE LAWS, COMPANY AND THE LICENSORS MAKE NO GUARANTEES, REPRESENTATIONS OR WARRANTIES OF ANY KIND, EXPRESS OR IMPLIED, ARISING BY LAW OR OTHERWISE, INCLUDING BUT NOT LIMITED TO, content, QUALITY, accuracy, completeness, effectiveness, reliability, PERFORMANCE, MERCHANTABILITY, FITNESS FOR A PARTICULAR PURPOSE, NON-INFRINGEMENT, usefulness, use or results to be obtained from the Product, or that the Product or server will be uninterrupted or error-free, OR THAT ERRORS IN THE PRODUCT OR NONCONFORMITY TO ITS DOCUMENTATION CAN OR WILL BE CORRECTED.

YOU ACKNOWLEDGE THAT THE PROVISIONS OF THIS SECTION ARE A MATERIAL INDUCEMENT AND CONSIDERATION TO COMPANY AND THE LICENSORS TO GRANT THE LICENSE CONTAINED IN THIS EULA AND TO PROVIDE YOU WITH ACCESS TO THE SERVICES.

**Limitation of Liability.**

TO THE MAXIMUM EXTENT PERMITTED UNDER THE APPLICABLE LAWS, COMPANY AND THE LICENSORS SHALL NOT BE LIABLE TO YOU: IN RESPECT OF ANY CLAIM, DEMAND OR ACTION, IRRESPECTIVE OF THE NATURE OF THE CAUSE OF THE CLAIM, DEMAND OR ACTION ALLEGING ANY LOSS, INJURY OR DAMAGES, DIRECT OR INDIRECT, INCURRED BY YOU OR ANY THIRD PARTY WHICH MAY ARISE IN CONNECTION WITH OR RESULT FROM THE USE OR POSSESSION OF THE PRODUCT; OR FOR ANY LOSS OF DATA, PROFIT, REVENUE, CONTRACTS OR SAVINGS, OR OTHER DIRECT, INDIRECT, INCIDENTAL, SPECIAL OR CONSEQUENTIAL DAMAGES ARISING OUT OF YOUR USE OF OR INABILITY TO USE THE PRODUCT, ANY DEFECT IN THE PRODUCT, OR THE BREACH OF THESE TERMS OR CONDITIONS, WHETHER IN AN ACTION IN CONTRACT OR TORT OR BASED ON A WARRANTY, EVEN IF COMPANY OR THE LICENSORS HAVE BEEN ADVISED OF THE POSSIBILITY OF SUCH DAMAGES AND NOTWITHSTANDING THE FAILURE OF ANY LIMITED REMEDY PROVIDED HEREIN.

Exclusions.

Some jurisdictions do not allow certain warranty exclusions or the limitation or exclusion of liability, so to that extent the above exclusion may not apply to you.

To the extent that COMPANY may not, as a matter of applicable law, disclaim any implied warranty or limit its liabilities, the scope and duration of such warranty and the extent of COMPANY's liability shall be the minimum permitted under such applicable law.

The disclaimer of warranty and limitation of liability set forth in this EULA does not affect or prejudice your statutory rights where you have acquired the Product otherwise than in the course of business.



Third-Party Copyright Notices.

The third-party sourced data has been incorporated into or made a part of the Product and is being sublicensed to you subject to the terms and conditions of this EULA.

In this regard, you shall not remove or tamper with any intellectual property rights notice attached or used in relation to data supplied by the Licensors.

Entire Agreement.

This EULA is the entire agreement between COMPANY (and the Licensors) and you pertaining to the subject matter hereof, and supersedes in their entirety any and all previous written or oral communications or documents (including, if you are obtaining an update, any agreement that may have been included with an earlier version of the Product) with respect to such subject matter.

Governing Law.

This EULA shall be governed by the laws of the jurisdiction in which you reside at the date of acquisition of the Product.

Should you at that moment reside outside the European Union or Switzerland, the law of the jurisdiction within the European Union or Switzerland where you acquired the Product shall apply.

In all other cases, or if the jurisdiction where you acquired the Product cannot be defined, the laws of the Republic of Korea shall apply.

This EULA will not be governed by the U.N. Convention on Contracts for the International Sale of Goods.

The courts competent at your place of residence at the time you acquired the Product shall have jurisdiction over any dispute arising out of, or relating to this EULA, without prejudice to COMPANY's right to bring claims at your then current place of residence.



Export Control.

You agree not to export or re-export from anywhere any part of the Product in any form except in compliance with applicable export laws, rules and regulations, including but not limited to the laws, rules and regulations administered by the Office of Foreign Assets Control of the U.S. Department of Commerce and the Bureau of Industry and Security of the U.S. Department of Commerce.

Miscellaneous.

If any provision of this EULA is found to be invalid or unenforceable, it will be enforced to the extent permissible and the remainder of this EULA will remain in full force and effect.

Failure by COMPANY to prosecute any right with respect to a default hereunder will not constitute a waiver by COMPANY of the right to enforce rights with respect to the same or any other breach.

No refunds or replacements will be permitted on damaged Product.

**U.S. Government End Users.**

If the Product is being acquired by or on behalf of the United States Government or any other entity seeking or applying rights similar to those customarily claimed by the United States Government, this Product and related documentation are "Commercial Items" as that term is defined at 48 C.F.R. ("FAR") 2.101.

This Product and related documentation are licensed to the United States Government end users (a) only as "Commercial Items" and (b) with only those rights as are granted to all other end users in accordance with this EULA, and each copy of Product delivered or otherwise furnished shall be marked and embedded as appropriate with the following "Notice of Use," and shall be treated in accordance with such Notice:

Notice of Use.

Contractor (Manufacturer/Supplier) Name: Hyundai Autoever, CORP.

This Product and related documentation are commercial items as defined in FAR 2.101 and is subject to this EULA under which this Product is provided.

© 2021 Hyundai Autoever. All rights reserved.

If the Contracting Officer, federal government agency, or any federal official refuses to use the legend provided herein, the Contracting Officer, federal government agency, or any federal official must notify COMPANY prior to seeking additional or alternative rights in the Product.

End-User Terms Required by HERE.

The Product utilizes map data that COMPANY licenses from HERE and the following copyright notices apply to such map data (the "HERE Data"): © 2021 HERE. All rights reserved.

The HERE Data for areas of Canada includes information taken with permission from Canadian authorities, including:

© Her Majesty the Queen in Right of Canada, © Queen's Printer for Ontario, © Canada Post Corporation, GeoBase.®, © Department of Natural Resources Canada. All rights reserved.

HERE holds a non-exclusive license from the United States Postal Service® to publish and sell ZIP+4® information.

©United States Postal Service® 2021. Prices are not established, controlled or approved by the United States Postal Service®.

The following trademarks and registrations are owned by the USPS: United States Postal Service, USPS, and ZIP+4.



All Map Database cannot be copied without permission.

Copyright Notice: © 1987 - 2022 HERE.

You may not otherwise reproduce, modify and distribute the content without the prior written consent of HERE Technologies and Hyundai Autoever, CORP.



Copyright for Brand Icon

The marks of companies displayed by this product to indicate business locations are the marks of their respective owners.

The use of such marks in this product does not imply any sponsorship, approval, or endorsement by such companies of this product.

Copyright for Junction View

Junction View Data provided by ZENRIN USA, INC. Copyright(C) 2021, All rights Reserved.

About Map Updates

You can contact your dealer.

Information:

This product requires regular updates for new functions and map updates. Updating may require up to 1 hour depending on the data size.

Turning off the power or ejecting the USB during the update process may result in damage to the system. Make sure to keep the ignition on and wait until updating is complete.

CAUTION:

- The use of an uncertified USB may result in damage to the system due to heat related deformation.
- Product malfunctions caused by the use of an uncertified cards shall not be covered within the product warranty.
- Repeatedly connecting/disconnecting the USB in a short period of time may cause damage to the device.

SPECIFICATION

AV/NAVIGATION PRODUCT SPECIFICATION

Common	Power Supply	DC 12 V
	Operation Power	DC 9 ~ 16 V
	Current Consumption	Max. 6 A
	Dark Current (average)	Max. 1 mA
	Operating Temperature	-20 ~ 70 °C
	Storage Temperature	-40 ~ 85 °C
	Dimensions (HeadUnit)	178 (W) x 70 (H) x 153.8 (D) mm
	Weight (Headunit)	1,989 kg
Front Monitor	Screen Size (Outline Dimension)	847,06(H) x 162,65(V) x 7,99(D) mm (Typ.), (W/O PemNut, W/Cover Glass 1.1T)
	Resolution	1920 x 720 (12.3") / 1920 x 720 (12.3")
	Operating Method	TFT, In Plane Switching (IPS), Active Metrix
	Viewing Angle	89/89/89/89 (L/R/U/D)
	Internal Lighting	LED
SiriusXM™	Frequency Range	2320 ~ 2345 Mhz
	Min. Sensitivity	-80 dBm
	T,H,D	Max. 0,2%
Bluetooth	Supported Profile	HFP 1.7/A2DP 1.3/AVRCP 1.6/PBAP 1.2/MAP 1.2/SPP 1.2/BIP 1.2
	Supported Bluetooth Specification	5,1
	Frequency Range/Output Power	2402 ~ 2480 Mhz Max. 4,0 dBm
	Number of Channels	79
Radio	AM	
	Tuning Range	530~1710 KHz
	Usable Sensitivity	35 dBuV
	SNR Ratio	45 dB
	FM	
	Tuning Range	87,5 ~ 107,9 Mhz
	Usable Sensitivity	10 dBuV
SNR Ratio	50 dB	



-
- To obtain the source code under GPL, LGPL, MPL and other open source licenses, that is contained in this product, please visit <http://opensource.lge.com>.
 - In addition to the source code, all referred license terms, warranty disclaimers and copyright notices are available for download.
 - LG Electronics will also provide open source code to you on CD-ROM for a charge covering the cost of performing such distribution (such as the cost of media, shipping and handling) upon email request to opensource@lge.com.
 - This offer is valid for three (3) years from the date on which you purchased the product.
 - Designs and specifications are subject to change without prior notice.



OPEN SOURCE SOFTWARE NOTICE

This product from LG Electronics, Inc. contains the open source software detailed below. Please refer to the indicated open source licenses (as are included following this notice) for the terms and conditions of their use.

Open Source	License	Copyright
acl 2.2.52	GPL-2.0 LGPL-2.1	Copyright (c) 1999-2002 Andreas Gruenbacher, <a.gruenbacher@bestbits.at> Copyright (c) 2000-2002 Silicon Graphics, Inc.
alsa-lib 1.1.2	LGPL-2.1	
alsa-plugins 1.1.1	GPL-2.0 LGPL-2.1	
alsa-utils 1.1.2	GPL-2.0	
android-external-dnsmasq	GPL-2.0	
ATK 2.20.0	LGPL-2.1	
attr 2.4.47	GPL-2.0	Copyright (c) 2002 Andreas Gruenbacher <agruen@suse.de>, SuSE Linux AG. Copyright (c) 2001-2003,2005 Silicon Graphics, Inc.
AudioManager 7.0	MPL-2.0	Copyright (C) 2012, GENIVI Alliance, Inc. Copyright (C) 2012, BMW AG
audit 2.7	GPL-2.0 LGPL-2.1	Copyright (c) 2004-2016, Red Hat Inc., Durham, North Carolina.
automake 1.15	GPL-2.0	Copyright (c) 1997, 1998, 2001, 2002, 2003, 2004, 2005, 2006, 2007, 2010, 2011, 2012 Free Software Foundation, Inc
avahi 0.7	LGPL-2.1	Copyright (c) 2003, 2004 Porchdog Software. Copyright (c) 2006-2007 Collabora Ltd.
base-files 3.0.14	GPL-2.0	Copyright (c) 2016 Yocto Project, A Linux Foundation Collaborative Project.
base-passwd 3.5.29	GPL-2.0	Copyright (c) 1999-2002 Wichert Akkerman <wichert@deephackmode.org> Copyright (c) 2002, 2003, 2004 Colin Watson <cjwatson@debian.org>
bash 3.2.57	GPL-2.0	Copyright (c) 1987-2005 Free Software Foundation, Inc.
bash-completion 2.4	GPL-2.0	Copyright (c) David Paleino (Debian) Copyright (c) Freddy Vulto Copyright (c) Guillaume Rousse (Mandriva) Copyright (c) Igor Murzov Copyright (c) Mike Kelly (Exherbo) Copyright (c) Santiago M. Mola (Exherbo) Copyright (c) Ville Skyttä (Fedora/Red Hat)
Bellagio OpenMAX IL 0.9.3	LGPL-2.1	
bison 2.3	GPL-2.0	Copyright (C) 2002, 2003, 2004, 2005, 2006 Free Software Foundation, Inc.
bluez 5.50	GPL-2.0 LGPL-2.1	Copyright (c) 2007-2017, Intel Corporation Copyright (c) 2002-2014, Marcel Holtmann <marcel@holtmann.org> Copyright (c) 2005-2010, Nokia Corporation Copyright (c) 2000-2003, Qualcomm Incorporated
bridge-utils 1.5	GPL-2.0	Copyright (c) 2000 Lennert Buytenhek

BusyBox 1.24.1	GPL-2.0	Copyright (c) 1999-2008 Erik Andersen
ca-certificates 20160104	GPL-2.0	Copyright (c) 2003 Fumitoshi UKAI <ukai@debian.or.jp> Copyright (c) 2009 Philipp Kern <pkern@debian.org> Copyright (c) 2011 Michael Shuler <michael@pbandjelly.org> Copyright (c) Various Debian Contributors
cairo 1.14.12	LGPL-2.1	Copyright (c) 2002 University of Southern California Copyright (c) 2005 Red Hat, Inc.
cairo 1.4.12	MPL-1.1	Copyright (c) 2002 University of Southern California Copyright (c) 2005 Red Hat, Inc.
can-utils	GPL-2.0	Copyright (c) 2002-2008 Volkswagen Group Electronic Research
Check 0.10.0	LGPL-2.1	Copyright (c) 2001, 2002 Arien Malec Copyright (c) 2011 Mateusz Loskot Copyright (c) 2008 Holger Weiss Copyright (c) 1995 Patrick Powell
Common API C++ core runtime 3.1.5	MPL-2.0	Copyright (c) 2013-2014 BMW Group
Common API C++ dbus runtime 3.1.5	MPL-2.0	Copyright (c) 2013-2015 Bayerische Motoren Werke Aktiengesellschaft (BMW AG) Copyright (c) 2016-2017, GENIVI Alliance, Inc.
Common API C++ SOMEIP runtime 3.1.5	MPL-2.0	Copyright (c) 2014-2017 Bayerische Motoren Werke Aktiengesellschaft (BMW AG)
connman 1.29	GPL-2.0	Copyright (c) 2007-2012 Intel Corporation.
coreutils 6.9	GPL-2.0	Copyright (c) 2005, 2006 Free Software Foundation, Inc.
cracklib 2.9.5	LGPL-2.1	Copyright (c) 1993 Alec Muffett <alecm@crypto.dircon.co.uk> Copyright (c) Nathan Neulinger <nneul@neulinger.org> Copyright (c) 2003, Domenico Andreoli, Copyright (c) 2008, 2009, 2012 Jan Dittberner <jan@dittberner.info>
cryptodev-linux 1.8	GPL-2.0	Copyright (c) Michal Ludvig Copyright (c) Nikos Mavrogiannopoulos Copyright (c) Michael Weiser Copyright (c) Phil Sutter Copyright (c) Dmitry Kasatkin Copyright (c) Nikos Mavrogiannopoulos (nmav [at] gnutls [dot] org)
cryptsetup 1.7.2	GPL-2.0 LGPL-2.1	Copyright (c) 2009-2016, Red Hat, Inc. Copyright (c) 2009-2016, Milan Broz Copyright (c) 2004-2007, Clemens Fruhwirth <clemens@endorphin.org> Copyright (c) 2004, Jana Saout <jana@saout.de>
dhcp 4.4.1	MPL-2.0	Copyright (c) 2004-2018, Internet Systems Consortium, Inc. ("ISC") Copyright (c) 1995-2003, Internet Software Consortium
dlt-daemon 2.16.0	MPL-2.0	Copyright (C) 2011-2015, BMW AG
dosfstools 2.11	GPL-2.0	Copyright (c) 1993, 1994 David Hudson (dave@humbug.demon.co.uk) Copyright (c) 1992, 1993 Remy Card (card@masi.ibp.fr) and 1991 Linus Torvalds (torvalds@klaava.helsinki.fi) Copyright (c) Werner Almesberger <almesber@lrc.di.epfl.ch> and Roman Hodek <Roman.Hodek@informatik.uni-erlangen.de>.

e2fsprogs 1.43	GPL-2.0 LGPL-2.1	<p>Copyright (c) 1995 Gadi Oxman Copyright (c) 1995-2010, Theodore Ts'o Copyright (c) 1999 Andrea Arcangeli <andrea@suse.de> Copyright (c) 2000 Andreas Gruenbacher, <a.gruenbacher@computer.org> Copyright (c) 2002 David Woodhouse <dwmw2@infradead.org> Copyright (c) 1998-2000 Red Hat, Inc Copyright (c) 2014 Google Inc. Copyright (c) 1992-1995 Remy Card (card@masi.ibp.fr) Laboratoire MASI - Institut Blaise Pascal Université Pierre et Marie Curie (Paris VI) Copyright (c) 2014 Oracle. Copyright (c) 1999, 2001 Andreas Dilger (adilger@turbolinux.com) Copyright (c) 2004 Kay Sievers <kay.sievers@vrfy.org> Copyright (c) 1995-1999, 2000-2003 Free Software Foundation, Inc. Copyright (c) 1986-1989, MIT Information Systems and the MIT Student Information Processing Board.</p>
ecryptfs-utils 111	GPL-2.0	<p>Copyright (C) 2007 International Business Machines Author(s): Michael Halcrow <mhalcrow@us.ibm.com> Dustin Kirkland <kirkland@ubuntu.com></p>
Eigen 3.3.4	MPL-2.0	<p>Copyright (c) 2008-2016 Gael Guennebaud <gael.guennebaud@inria.fr> Copyright (c) 2006-2010 Benoit Jacob <jacob.benoit.1@gmail.com> Copyright (c) 2009 Rohit Garg <rpg.314@gmail.com> Copyright (c) 2009 Mathieu Gautier <mathieu.gautier@cea.fr> Copyright (c) 2009 Keir Mierle <mierle@gmail.com> Copyright (c) 2011 Timothy E. Holy <tim.holy@gmail.com > Copyright (c) 2007 Julien Pommier Copyright (c) 2010 Thomas Capricelli <orzef@freehackers.org> Copyright (c) 2009-2013 Hauke Heibel <hauke.heibel@gmail.com> Copyright (c) 2010-2016 Konstantinos Margaritis <markos@freevec.org> Copyright (c) 2010-2013 Jitse Niesen <jitse@maths.leeds.ac.uk> Copyright (c) 2013 Pavel Holoborodko <pavel@holoborodko.com> Copyright (c) 2014-2016 Benoit Steiner <benoit.steiner.goog@gmail.com> Copyright (c) 2014-2016 Pedro Gonnet (pedro.gonnet@gmail.com) Copyright (c) 2016 Eugene Brevdo <ebrevdo@gmail.com> Copyright (c) 2016 Fabian Giesen Copyright (c) 2010 Daniel Lowengrub <lowdanie@gmail.com> Copyright (c) 2016 Rasmus Munk Larsen <rmlarsen@google.com> Copyright (c) 2010 Vincent Lejeune Copyright (c) 2009 Claire Maurice Copyright (c) 2016 Tobias Wood <tobias@spincist.org.uk> Copyright (c) 2012 Alexey Korepanov <kaikaikai@yandex.ru> Copyright (c) 2011 Intel Corporation. Copyright (c) 1994 Xerox Corporation. Copyright (c) 2006 Timothy A. Davis. http://www.suitesparse.com Copyright (c) 1998-2003 the University of Florida. Copyright (c) 2012-2013 Desire Nuentza <desire.nuentza_wakam@inria.fr> Copyright (c) 2013 Pierre Zoppitelli <pierre.zoppitelli@ensimag.fr> Copyright (c) 2013 Jean Ceccato <jean.ceccato@ensimag.fr> Copyright (c) 2013 Gauthier Brun <brun.gauthier@gmail.com></p>
elfutils 0.148	GPL-2.0	<p>Copyright (c) 2011 Linux Foundation. Copyright (c) 2009 Red Hat, Inc.</p>
ethtool 4.6	GPL-2.0	<p>Copyright (c) 1996-2014, Free Software Foundation, Inc. Copyright (c) 2001, 2008, Sun Microsystems, Inc. Copyright (c) 2002, 2006-2009, 2012-2013, Intel Corporation Copyright (c) 2009-2012, Solarflare Communications Inc. Copyright (c) 1998-1999 David S. Miller.</p>
faad2 2.7	GPL-2.0	<p>Copyright (c) 2003-2005 M. Bakker, Nero AG, http://www.nero.com</p>
fbset 2.1	GPL-2.0	<p>Copyright (c) 1995-1998, Geert Uytterhoeven</p>

fdk-aac 2.0.1	Software License for The Fraunhofer FDK AAC Codec Library for Android	Copyright (c) 1995 - 2018 Fraunhofer-Gesellschaft zur Förderung der angewandten Forschung e.V.
ffmpeg 3.4.2	GPL-2.0 LGPL-2.1	Copyright (c) 2002-2013, Michael Niedermayer <michaelni@gmx.at> Copyright (c) 2000-2003, Fabrice Bellard Copyright (c) 2012-2017, Paul B Mahol Copyright (c) 2008-2012, Mans Rullgard <mans@mansr.com> Copyright (c) 2012, MIPS Technologies, Inc., California. Copyright (c) 2003-2006, Roman Shaposhnik Copyright (c) 2006, Daniel Maas <dmaas@maasdigital.com>
flac 1.3.1	GPL-2.0 LGPL-2.1	Copyright (c) 2011-2014 Xiph.Org Foundation Copyright (c) 2000-2009 Josh Coalson Copyright (c) 1998 Todd C. Miller <Todd.Miller@courtesan.com> Copyright (c) 2002-2009 Daisuke Shimamura Copyright (c) 1998-2000 Peter Alm, Mikael Alm, Olle Hallnas, Thomas Nilsson and 4Front Technologies Copyright (c) 2000-2002 Jerome Couderc <j.couderc@ifrance.com> Copyright (c) 1999-2001 Håvard Kvålen <havardk@xmms.org> Copyright (c) 2001 Edmund Grimley Evans <edmund@rano.org> Copyright (c) 2002 John Edwards Additional code Magnus Holmgren and Gian-Carlo Pascutto Copyright (c) 2001 Peter Harris <peter.harris@hummingbird.com> Copyright (c) 2001 David Robinson and Glen Sawyer Copyright (c) 1987-1999 Free Software Foundation, Inc. Copyright (c) 2003 Philip Jägenstedt Copyright (c) 2000-2001 Robert Leslie
gawk 3.1.5	GPL-2.0	Copyright (c) 2008 Free Software Foundation, Inc.
gconf 3.2.6	LGPL-2.1	Copyright (c) 1999, 2000 Red Hat Inc
gdbm 1.8.3	GPL-2.0	Copyright (C) 1990, 1991, 1993 Free Software Foundation, Inc.
gdk-pixbuf 2.36.11	LGPL-2.1	Copyright (c) 1999, 2002-2003, 2011-2012, The Free Software Foundation Copyright (c) 1999-2000, 2007, 2012-2016, Red Hat, Inc. Copyright (c) 2008 Alberto Ruiz Copyright (c) 2008 Dominic Lachowicz
GENIVI Node State Manager (NSM) 2.0.0	MPL-2.0	Copyright (C) 2012 Continental Automotive Systems, Inc
gettext 0.16.1	GPL-2.0 LGPL-2.1	Copyright (c) 1998, 2010, 2013 Free Software Foundation, Inc.
GLib 2.48.2	LGPL-2.1	Copyright (c) 2005 - 2015 The GNOME Project
glib-networking 2.48.2	LGPL-2.1	
glibc 2.24	GPL-2.0 LGPL-2.1	
gmp 6.1.1	GPL-2.0	Copyright (c) 2000, 2001, 2003 Free Software Foundation, Inc.
GnuTLS 3.3.17.1	LGPL-2.1	Copyright (c) 2000-2012, Free Software Foundation, Inc.
gobject-introspection 1.48.0	GPL-2.0 LGPL-2.1	
grep 2.5.1a	GPL-2.0	Copyright (c) 1996-2014 Free Software Foundation Inc.

gst-libav 1.8.3	LGPL-2.1	Copyright (c) 2008 Michael Niedermayer Copyright (c) 2009 Robert Swain (rob opendot cl) Copyright (c) 2002 Jindrich Makovicka Copyright (c) 2011 Stefano Sabatini
gst-plugins-bad 1.8.3	GPL-2.0 LGPL-2.1	Copyright (c) 1994-2014, Free Software Foundation, Inc. Copyright (c) 2012,2015, Matthew Waters Copyright (c) 2008, Filippo Argiolas Copyright (c) 2008-2016, Julien Isorce Copyright (c) 1999, Erik Walthinsen Copyright (c) 2007, Alessandro Decina Copyright (c) 2010, Ole André Vadla Ravnås Copyright (c) 2008-2009, Sebastian Dröge
gst-plugins-base 1.8.3	LGPL-2.1	Copyright (c) Erik Walthinsen <omega@temple-baptist.com> Copyright (c) Matt Howell <mhowell@users.sourceforge.net> Copyright (c) Brent Bradburn <bbradburn@users.sourceforge.net> Copyright (c) Wim Taymans <wim.taymans@gmail.com> Copyright (c) Richard Boulton <richard@tartarus.org> Copyright (c) Zaheer Abbas Merali <zaheerabbas at merali dot org> Copyright (c) David I. Lehn <dlehnn@users.sourceforge.net> Copyright (c) Chris Emerson <chris@tartarus.org> Copyright (c) Jens Thiele <karme@unforgettable.com> Copyright (c) Thomas Nyberg <thomas@codefactory.se> Copyright (c) Bastien Nocera <hadess@hadess.net> Copyright (c) Christian Fredrik Kalager Schaller <Uraeus@linuxrising.org> Copyright (c) Thomas Vander Stichele <thomas@apestaart.org> Copyright (c) Andy Wingo <wingo@pobox.com> Copyright (c) Cameron Hutchison <camh@xdna.net> Copyright (c) David Schleef <ds@schleef.org> Copyright (c) Benjamin Otte <in7y118@public.uni-hamburg.de> Copyright (c) Ronald Bultje <rbultje@ronald.bitfreak.net> Copyright (c) Julien MOUTTE <julien@moutte.net> Copyright (c) Jan Schmidt <thaytan@mad.scientist.com> Copyright (c) Arwed v. Merkatz <v.merkatz@gmx.net> Copyright (c) Tim-Philipp Müller <tim at centricular dot net> Copyright (c) Mark Borgerding <mark at borgerding dot net> (kissfft, used in libgstfft)
gst-plugins-good 1.8.3	LGPL-2.1	Copyright (c) 1999, Erik Walthinsen Copyright (c) 1994-2014 Free Software Foundation, Inc Copyright (c) 2005-2007, Wim Taymans Copyright (c) 2003, iOS-Software
gst-plugins-ugly 1.8.3	LGPL-2.1	Copyright (c) 1994-2014, Free Software Foundation, Inc. Copyright (c) 1999, Erik Walthinsen Copyright (c) 2006 , Tim-Philipp Müller Copyright (c) 2005-2007, Wim Taymans
Gstreamer 1.8.3	LGPL-2.1	Copyright (c) Erik Walthinsen <omega@temple-baptist.com> Copyright (c) Matt Howell <mhowell@users.sourceforge.net> Copyright (c) Brent Bradburn <bbradburn@users.sourceforge.net> Copyright (c) Wim Taymans <wim.taymans@chello.be> Copyright (c) Richard Boulton <richard@tartarus.org> Copyright (c) Zaheer Abbas Merali <zaheerabbas at merali dot org> Copyright (c) David I. Lehn <dlehnn@users.sourceforge.net> Copyright (c) Chris Emerson <chris@tartarus.org> Copyright (c) Jens Thiele <karme@unforgettable.com> Copyright (c) Thomas Nyberg <thomas@codefactory.se> Copyright (c) Bastien Nocera <hadess@hadess.net> Copyright (c) Christian Fredrik Kalager Schaller <Uraeus@linuxrising.org> Copyright (c) Thomas Vander Stichele <thomas@apestaart.org> Copyright (c) David Schleef <ds@schleef.org> Copyright (c) Benjamin Otte <in7y118@public.uni-hamburg.de> Copyright (c) Ronald Bultje <rbultje@ronald.bitfreak.net> Copyright (c) Andy Wingo <wingo@pobox.com> Copyright (c) Julien Moutte <julien@moutte.net> Copyright (c) Jan Schmidt <thaytan@noraisin.net>



GStreamer OpenMAX IL wrapper plugin 1.2.0	LGPL-2.1	Copyright (c) 2011, Hewlett-Packard Development Company, L.P. Copyright (c) 2013, Collabora Ltd. Copyright (c) 2014, Sebastian Dröge <sebastian@centricular.com>
GTK+ 3.12.2	LGPL-2.1	
guider 1.0	GPL-2.0	
gzip 1.3.12	GPL-2.0	Copyright (c) 1999, 2001 Free Software Foundation, Inc. Copyright (c) 1992, 1993 Jean-loup Gailly
i2c-tools 3.1.2	GPL-2.0	copyright (c) 2002-2003 Stefano Barbato <stefano@codesink.org> Copyright (c) 2013 Jaromir Capik Copyright (c) 2004-2010 Jean Delvare <jdelvare@suse.de> Copyright (c) 2005-2007 Mark M. Hoffman <mhoffman@lightlink.com> Copyright (c) 1998-1999 Frodo Looijgaard <frodo@dds.nl> Copyright (c) 1995-1997 Simon G. Vogl
init-ifupdown 1.0	GPL-2.0	
iproute2 4.7.0	GPL-2.0	
iptables 1.6.0	GPL-2.0	Copyright (c) 2002-2008 BalaBit IT Ltd. Copyright (c) 2000-2003 Michal Zalewski Copyright (c) 2003 Mike Frantzen Copyright (c) 2007-2008 CC Computer Consultants GmbH Copyright (c) 2000 Emmanuel Roger Copyright (c) 2003+ Evgeniy Polyakov Copyright (c) 2005 Evgeniy Polyakov Copyright (c) Martin F. Krafft Copyright (c) 2011 Jan Engelhardt Copyright (c) 2000-2002 Joakim Axelsson Copyright (c) 2003-2010 Jozsef Kadlecsek Copyright (c) 2006, 2008 Junio C Hamano Copyright (c) 2002,2004 MARA Systems AB Copyright (c) 2000 Marc Boucher Copyright (c) 2009 Matteo Frigo Copyright (c) 2009 Mike Frysinger Copyright (c) 2000-2001 Netfilter Core Team. Copyright (c) 2004, 2010 Nokia Corporation Copyright (c) 2011 Patrick McHardy Copyright (c) 2006 Red Hat, Inc., James Morris Copyright (c) 2007 Sebastian Claßen Copyright (c) 2009 Steven G. Johnson Copyright (c) 2007 Sven Schnelle Copyright (c) 2006 UfoMechanic Copyright (c) 2006 USAGI/WIDE Project
iptables 1.4.19.1	GPL-2.0	
iputils s20151218	GPL-2.0	
iso-codes 3.70	LGPL-2.1	

kbd 2.0.3	GPL-2.0	Copyright (c) 1992 Rickard E. Faith. Copyright (c) 1993 Risto Kankkunen. Copyright (c) 1993 Eugene G. Crosser. Copyright (c) 1994 H. Peter Anvin. Copyright (c) 1994-1999 Andries E. Brouwer. Copyright (c) 1994 by Jon Toms <jon@gtex02.us.es> Copyright (c) Andries E. Brouwer <aeb@cwi.nl> Copyright (c) Joshua Spoorri <josh@cooper.edu> Copyright (c) Chuck Martin <cmartin@bigfoot.com> Copyright (c) Alexey Gladkov <gladkov.alexey@gmail.com> Copyright (c) 2011 Canonical Ltd. Copyright (c) Seth Forshee <seth.forshee@canonical.com> Copyright (c) Dustin Kirkland <kirkland@canonical.com> Copyright (c) 1994-1998 Michael K. Johnson <johnsonm@redhat.com> Copyright (c) 2002, 2005 Dmitry V. Levin <ldv@altlinux.org>
keyutils 1.5.9	GPL-2.0 LGPL-2.1	Copyright (c) 2005-2006, 2011-2014, Red Hat, Inc.
kmod 23	GPL-2.0 LGPL-2.1	
libcgroup 0.41	LGPL-2.1	Copyright (c) 2007-2009 IBM Corporation. Copyright (c) 2008-2012 Red Hat, Inc. Copyright (c) 2005 Matt Helsley, IBM Corp. Derived from fcctl.c by Guillaume Thouvenin Copyright (c) 1996-1997, Cristian Gafton <gafton@redhat.com> Copyright (c) 2005 Guillaume Thouvenin, BULL SA. <guillaume.thouvenin@bull.net>
libcroco 0.6.13	LGPL-2.1	Copyright (c) 2002-2003 Dodji Seketeli <dodji@seketeli.org>
libdaemon 0.14	LGPL-2.1	
libdca 0.0.5	GPL-2.0	Copyright (c) 2000-2003 Michel Lespinaise <walken@zoy.org> Copyright (c) 1999-2000 Aaron Holtzman <aholtzma@ess.engr.uvic.ca> Copyright (C) 2004 Gildas Bazin <gbazin@videolan.org>
libebml 1.3.4	LGPL-2.1	
liberation-fonts 1.07.4 or earlier	GPL-2.0	Copyright (c) 2007 Red Hat, Inc.
libfuse 2.9.8	GPL-2.0 LGPL-2.1	Copyright (c) 2001-2007 Miklos Szeredi <miklos@szeredi.hu> Copyright (c) 2010 Miklos Szeredi <miklos@szeredi.hu> Copyright (c) 2008 SUSE Linux Products GmbH Copyright (c) 2008 Tejun Heo <teheo@suse.de>
libgcrypt 1.8.4	GPL-2.0 LGPL-2.1	Copyright (c) 2013-2016 Jussi Kiviniina <jussi.kiviniina@iki.fi> Copyright (c) 2012-2017 g10 Code GmbH Copyright (c) 2012, Intel Corporation Copyright (c) 2013 Stephan Mueller <smueller@chronox.de>
libgpg-error 1.28	LGPL-2.1	Copyright (c) 2003-2007, 2013-2014 g10 Code GmbH
libgudev 230	LGPL-2.1	Copyright (c) 2008 David Zeuthen <davidz@redhat.com> Copyright (c) 1999-2014 Free Software Foundation, Inc.
libical 3.0.6	MPL-2.0	Copyright (c) 1999-2001 Eric Busboom <eric@softwarestudio.org> Copyright (c) 2015 William Yu <williamyu@gnome.org> Copyright (c) 2001-2002 Critical Path
libiconv 1.14	LGPL-2.1	Copyright (c) 1998, 2010 Free Software Foundation, Inc.
libid3tag 0.15.1	GPL-2.0	Copyright (c) 2000-2004 Underbit Technologies, Inc.

libidn 0.6.14	GPL-2.0 LGPL-2.1	Copyright (C) 2002-2007, Simon Josefsson
libmatroska 1.4.5	LGPL-2.1	Copyright (C) 2002-2010 Steve Lhomme.
libmnl 1.0.4	LGPL-2.1	Copyright (c) 2008-2012 by Pablo Neira Ayuso <pablo@netfilter.org>
libnetfilter-contrack 1.0.4	GPL-2.0	Copyright (c) 1999-2014 Harald Welte, Pablo Neira Ayuso .
libnetfilter_acct 1.0.3	LGPL-2.1	Copyright (c) 2011 Pablo Neira Ayuso <pablo@netfilter.org> Copyright (c) 2011 Intra2Net AG < http://www.intra2net.com >
libnetfilter_log 1.0.1	GPL-2.0	Copyright (c) 2005 by Harald Welte <laforge@gnumonks.org> Copyright (c) 2005, 2008-2010 by Pablo Neira Ayuso <pablo@netfilter.org>
libnftnl 1.0.1	GPL-2.0	Copyright (c) 2001-2005 Netfilter Core Team <coreteam@netfilter.org>
libnl 3.2.28	LGPL-2.1	Copyright (c) 2003-2013 Thomas Graf <tgraf@suug.ch> Copyright (c) 2007 Secure Computing Corporation Copyright (c) 2007 Philip Craig <philipc@snapgear.com> Copyright (C) 1992-2013 Free Software Foundation, Inc. Copyright (c) 2013 Sassano Systems LLC <joe@sassanosystems.com> Copyright (c) 2013 Cong Wang <xiyou.wangcong@gmail.com> Copyright (c) 2014 Susant Sahani <susant@redhat.com> Copyright (c) 2012 Rich Fought <rich.fought@watchguard.com> Copyright (c) 2007, 2008 Patrick McHardy <kaber@trash.net>
libproxy 0.4.13	LGPL-2.1	Copyright (c) 2006-2010, Nathaniel McCallum Copyright (c) 2006-2007 Red Hat, Inc. Copyright (c) 2016 Fabian Vogt Copyright (c) 2010 Novell Inc. Copyright (c) 2010 SUSE LINUX Products GmbH, Nuernberg, Germany. Copyright (c) 2009 Goneri Le Bouder Copyright (c) 2008-2011, 2016, Dominique Leuenberger Copyright (c) 2005-2010 Kitware, Inc. Copyright (c) 2011 Bjoern Ricks Copyright (c) 2012 Rolf Eike Beer Copyright (c) 2007, 2009, Arno Rehn arno@arnorehn.de Copyright (c) 2008 Helio castro helio@kde.org
libqrencode 4.0.2	LGPL-2.1	Copyright (c) 2006-2017 Kentaro Fukuchi
libsvg 2.40.20	LGPL-2.1	Copyright (c) 2000, Eazel, Inc. Copyright (c) 2002, Dom Lachowicz <cinamod@hotmail.com> Copyright (c) 2006, Yangli Hector Yee Copyright (c) 2003, 2004, 2005, Caleb Moore <c.moore@student.unsw.edu.au> Copyright (c) 2002, 2003, 2004, 2005, Dom Lachowicz <cinamod@hotmail.com> Copyright (c) 1994-2013, Free Software Foundation, Inc.
libsamplerate 0.1.8	GPL-2.0 LGPL-2.1	Copyright (c) 1999-2011 Erik de Castro Lopo
libsndfile 1.0.28	LGPL-2.1	Copyright (c) 1999-2017, Erik de Castro Lopo Copyright (c) 1992, Jutta Degener and Carsten Bormann, Technische Copyright (c) 2011, Apple Inc. Copyright (c) 1994-2016 Free Software Foundation, Inc.
libsocketcan 0.0.10	LGPL-2.1	Copyright (c) 2009, Luotao Fu, Pengutronix
libsoup 2.54.1	LGPL-2.1	-
libtool 2.4.6	GPL-2.0 LGPL-2.1	Copyright (c) 1996, 1998-2015 Free Software Foundation, Inc.

libusb 1.0,2.0	LGPL-2.1	Copyright (c) 2001 Johannes Erdfelt <johannes@erdfelt.com> Copyright (c) 2007-2009 Daniel Drake <dstd@gentoo.org> Copyright (c) 2010-2012 Peter Stuge <peter@stuge.se> Copyright (c) 2008-2013 Nathan Hjelm <nhjelm@users.sourceforge.net> Copyright (c) 2009-2013 Pete Batard <pete@akeo.ie> Copyright (c) 2009-2013 Ludovic Rousseau <ludovic.rousseau@gmail.com> Copyright (c) 2010-2012 Michael Plante <michael.plante@gmail.com> Copyright (c) 2011-2013 Hans de Goede <hdegoede@redhat.com> Copyright (c) 2012-2013 Martin Pleuchot <mpi@openbsd.org> Copyright (c) 2012-2013 Toby Gray <toby.gray@realvnc.com> Copyright (c) 2013-2015 Chris Dickens <christopher_a.dickens@gmail.com>
libusb-compat 0.1,5	LGPL-2.1	
LIGHT MEDIA SCANNER 0.5.1	LGPL-2.1	
LIGHT MEDIA SCANNER	LGPL-2.1	
linux-libc-headers 4.9	GPL-2.0	
Linux-PAM 1.3.0	GPL-2.0	Copyright (c) YEAR Linux-PAM Project Copyright (c) 2005-2010, Thorsten Kukuk <kukuk@suse.de> Copyright (c) 2005-2009, Red Hat, Inc.
linuxptp 1.6	GPL-2.0	Copyright (c) 2011-2013, 2015, Richard Cochran <richardcochran@gmail.com> Copyright (c) 2013-2015, Miroslav Lichvar <mlichvar@redhat.com> Copyright (c) 2013, Delio Brignoli <dbrignoli@audioscience.com>
logrotate 3.13.0	GPL-2.0	Copyright (c) 1995-2001 Red Hat, Inc.
ltrace 0.7.91	GPL-2.0	
lvmm2 2.02.138	GPL-2.0 LGPL-2.1	
LZMA Utils 5.2.2	GPL-2.0	
lzo 2.09	GPL-2.0	Copyright (C) 1996 - 2015 Markus F.X.J. Oberhumer
m4 1.4.9	GPL-2.0	
media-manager	MPL-2.0	Copyright (c) 2014, Jaguar Land Rover
media-manager-interfaces	MPL-2.0	Copyright (c) 2014, Jaguar Land Rover
minicom 2.7	GPL-2.0	Minicom is Copyright (C) 1991,1992,1993,1994,1995,1996 Miquel van Smoorenburg.
mmc-utils	GPL-2.0	Copyright (c) 2016 SanDisk Corp
Mozilla Firefox	MPL-1.1	
mp4v2 2.0.0	MPL-1.1	Copyright (C) Cisco Systems Inc. 2001. Copyright (C) Ximpo Group Ltd. 2003, 2004. Copyright (C) 2008 Kona Blend.
mpg123 1.23.6	LGPL-2.1	Copyright (c) 1995-2013 by Michael Hipp and others
mtd-utils 1.5.2	GPL-2.0	
neard 0.16	GPL-2.0	Copyright (C) 2011 Intel Corporation. Copyright (C) 2004-2010 Marcel Holtmann <marcel@holtmann.org>



neon 0,30.1	LGPL-2.1	<p>Copyright (c) 1999-2008 Joe Orton <joe@manyfish.co.uk> Portions are: Copyright (c) Aleix Conchillo Flaque <aleix@member.fsf.org> Copyright (c) Arfrever Frehtes Taifers Arahesis Copyright (c) Arun Garg <arung@pspl.co.in> Copyright (c) Daniel Stenberg <daniel@haxx.se> Copyright (c) Free Software Foundation, Inc. Copyright (c) Henrik Holst <henrik.holst2@gmail.com> Copyright (c) Jiang Lei <tristone@deluxe.ocn.ne.jp> Copyright (c) Kai Sommerfeld <kso@openoffice.org> Copyright (c) Karl Ove Hufthammer, Copyright (c) Michael Sobolev Copyright (c) Nobuyuki Tschimura <tutimura@nn.iij4u.or.jp> Copyright (c) Sylvain Glaise <mokona@puupuu.org> Copyright (c) Thomas Schultz <tststs@gmx.de> Copyright (c) Vladimir Berezniker @ http://public.xdi.org/=vmpn Copyright (c) Yves Martin <ymartin59@free.fr></p>
net-tools 1,60-26	GPL-2.0	<p>Copyright (c) 1993 Fred Baumgarten Copyright (c) 1999-2000 Free Software Foundation, Inc. Copyright (c) 1999 J.M.Vansteene Copyright (c) 1999 Ralf B?hle Copyright (c) 1997-2000 Andi Kleen Copyright (c) 1988-1994 MicroWalt Corporation Copyright (c) 1995-1996, 2000-2007 Bernd Eckenfels Copyright (c) 2000 David A. Hinds Copyright (c) 1994 John Paul Morrison (VE7JPM), Copyright (c) 1997-2000 Donald Becker Copyright (c) 2008-2009 Luk Claes, Martin Ferrari Copyright (c) 2000 Anthony Towns</p>
net-tools 1.60	GPL-2.0	<p>Copyright (c) 1988-1994 MicroWalt Corporation Copyright (c) 1995-1996 Bernd Eckenfels Copyright (c) 1997-2000 Andi Kleen Copyright (c) 1997-2000 Donald Becker Copyright (c) 2008-2009 Luk Claes, Martin Ferrari Copyright (c) 2000-2007 Bernd Eckenfels Copyright (c) 2000 Anthony Towns</p>
netbase 5.3	GPL-2.0	<p>Copyright (c) 1987,88,89,90,91,92,93,94,95,96,98,99,2000,2001 Free Software Foundation, Inc. Copyright (c) 1994-2010 Peter Tobias, Anthony Towns and Marco d'Itri</p>
nettle 2,7.1	GPL-2.0 LGPL-2.1	<p>Copyright (c) 2002 Niels M?ller Copyright (c) 1992 Dana L. How</p>
nfacct 1,0.2	GPL-2.0	<p>Copyright (c) 2011 by Pablo Neira Ayuso <pablo@netfilter.org> Copyright (c) 2011 by Intra2net AG <http://www.intra2net.com></p>
node-health-monitor 1,3,5	MPL-2.0	Copyright (C) 2013 Continental Automotive Systems, Inc.
node-startup-controller 1,0,3	MPL-2.0	
nspr 4,12	MPL-2.0	Copyright (c) 1998-2000 Netscape Communications Corporation
nss 3,25	MPL-2.0	
nss-mdns 0,10	LGPL-2.1	Copyright (c) 2004-2007 Lennart Poettering <mzaffzqaf (at) Opointer (dot) de>
nvidia-linux 4,9	GPL-2.0	
obexftp 0,23	GPL-2.0	Copyright (c) 2002 Christian W. Zuckschwerdt <zany@triq.net>
ofono 1,16	GPL-2.0	Copyright (C) 2008-2011 Intel Corporation.

openobex 1.5	GPL-2.0 LGPL-2.1	Copyright (c) 1998-2000 Dag Brattli <dagb@cs.uit.no> Copyright (c) 1999-2000 Pontus Fuchs <pontus.fuchs@tactel.se> Copyright (c) 2001-2002 Jean Tourrilhes <jt@hpl.hp.com> Copyright (c) 2002-2008 Marcel Holtmann <marcel@holtmann.org>
opkg-utils 0.3.2	GPL-2.0	
pango 1.40.1	LGPL-2.1	Copyright (C) 2000 Red Hat Software Copyright (C) 2001 Sun Microsystems Copyright (C) 2005-2007 Imendio AB Copyright (C) 2010 Kristian Rietveld <kris@gtk.org> Copyright (C) 2000 Tor Lillqvist Copyright (C) 2001 Alexander Larsson Copyright (C) 2001,2002 Behdad Esfahbod. Copyright (C) 2007 Novell, Inc. Copyright (C) 1999,2000 Dov Grobgedl
pciutils 3.5.1	GPL-2.0	Copyright (c) 1997-2015, Martin Mares
persistence-administrator 1.0.5	MPL-2.0	Copyright (C) 2012 Continental Automotive Systems, Inc.
persistence-administrator	MPL-2.0	
persistence-client-library 1.0.0	MPL-2.0	Copyright (C) 2016 Mentor Graphics.
persistence-common-object 1.0.3	MPL-2.0	Copyright (c) 2012 Continental Automotive Systems, Inc.
persistence-common-object	MPL-2.0	Copyright (c) 2012 Continental Automotive Systems, Inc.
ppp 2.4.7	GPL-2.0 LGPL-2.1	Copyright (C) 2000 by Roaring Penguin Software Inc. Copyright (C) 2006,2007,2008 Katalix Systems Ltd Copyright (C) Andrew Tridgell 1999-2004
pps-tools	GPL-2.0	Copyright (C) 2009-2011 Alexander Gordeev <alex@gordick.net> Copyright (C) 2005-2007 Rodolfo Giometti <giometti@linux.it>
procps 3.3.12	GPL-2.0 LGPL-2.1	
psmisc 22.21	GPL-2.0	
psplash 0.1	GPL-2.0	Copyright (c) 2006 Matthew Allum <mallum@o-hand.com>
pulseaudio 9.0	GPL-2.0 LGPL-2.1	Copyright (c) 2004-2006 Lennart Poettering Copyright (c) 2006 Pierre Ossman <ossman@cendio.se> for Cendio AB Copyright (c) 2009 Tanu Kaskinen Copyright (c) 2009 Vincent Filali-Ansary <filali.v@azurdigitalnetworks.net> Copyright (c) 2008 Colin Guthrie
PyGObject 3.20.1	LGPL-2.1	Copyright (c) James Henstridge <james@daa.com.au> Copyright (c) Johan Dahlin <johan@gnome.org> Copyright (c) Tomeu Vizoso <tomeu.vizoso@collabora.co.uk> Copyright (c) Martin Pitt <martinpitt@gnome.org> Copyright (c) Paolo Borelli <pborelli@gnome.org> Copyright (c) Ignacio Casal Quinteiro <icq@gnome.org> Copyright (c) Sebastian Pölsterl <sebp@k-d-w.org> Copyright (c) Simon Feltman <sfeltman@gnome.org> Copyright (c) 1992-2015 Free Software Foundation, Inc.
quota 4.03	GPL-2.0	Copyright (c) 2007 SUSE CR Copyright (c) 2000 Silicon Graphics, Inc.
readline 5.2	GPL-2.0	Copyright (c) 1987-2010 Free Software Foundation, Inc.

rpm 5.4.16	GPL-2.0 LGPL-2.1	
rt-tests 1.1	GPL-2.0	
sbc 1.3	GPL-2.0 LGPL-2.1	Copyright (c) 2008-2010 Nokia Corporation Copyright (c) 2004-2010 Marcel Holtmann <marcel@holtmann.org> Copyright (c) 2004-2005 Henryk Plötz <henryk@ploetzli.ch> Copyright (c) 2005-2008 Brad Midgley <bmidgley@xmission.com>
sed 4.1.2	GPL-2.0	
shadow 4.2.1	GPL-2.0	Copyright (c) 1989 - 1994, Julianne Frances Haugh Copyright (c) 1996 - 2001, Marek Michałkiewicz Copyright (c) 2001 - 2006, Tomasz Kłoczko Copyright (c) 2004 The FreeBSD Project Copyright (c) 1997, Guy Maor <maor@ece.utexas.edu> Copyright (c) 2007 - 2013, Nicolas François Copyright (c) 1991 - 1993, Chip Rosenthal
shared-mime-info 1.6	GPL-2.0	
smack 1.1.0	GPL-2.0	Copyright (c) 2011, 2012, 2013 Intel Corporation Copyright (c) 2010, 2011 Nokia Corporation Copyright (c) 2012, 2013 Samsung Electronics Co.
smart 1.5	GPL-2.0	Copyright (c) 2004 Conectiva, Inc.
smem 1.4	GPL-2.0	Copyright (c) 2008-2009 Matt Mackall <mpm@selenic.com>
Socat 1.7.3.1	GNU General Public License v2.0 w/ OpenSSL Exception	Copyright (c) 2001-2011, Gerhard Rieger and contributors
sysutils 2.1.0	GPL-2.0 LGPL-2.1	Copyright (c) Ananth Mavinakayanahalli Copyright (c) Daniel Stekloff Copyright (c) Mohan Kumar Copyright (c) Nitin Vashisth Copyright (c) Ananth Mavinakayanahalli Copyright (c) Daniel Stekloff Copyright (c) Mohan Kumar Copyright (c) Nitin Vashisth
systemd 230	GPL-2.0 LGPL-2.1	Copyright (c) 2010-2016 Lennart Poettering, Copyright (c) 2017 Zbigniew Jędrzejewski-Szmek
systemd-serialgetty	LGPL-2.1	
taglib 1.9.1	LGPL-2.1	Copyright (c) 2002 - 2008 by Scott Wheeler Copyright (c) 2010 by Alex Novichkov Copyright (c) 2006 by Lukáš Lalinský Copyright (c) 2004 by Allan Sandfeld Jensen
tar 1.17	GPL-2.0	
tslib 1.1	LGPL-2.1	Copyright (c) 2001-2002, Russell King. Copyright (c) 2002-2003, Douglas Lowder Copyright (c) 2003-2006, Chris Larson.
ulogd 2.0.7	GPL-2.0	Copyright (c) 2000-2006 by Harald Welte <laforge@gnumonks.org> Copyright (c) 2008-2012 Pablo Neira Ayuso <pablo@netfilter.org> Copyright (c) 2008-2013 Eric Leblond <eric@regit.org>
update-rc.d 0.7	GPL-2.0	Copyright (c) 2003, 2004 Phil Blundell <pb@handhelds.org>



usbutils 008	GPL-2.0	Copyright (c) Thomas Sailer, <t.sailer@alumni.ethz.ch> Copyright (c) Johannes Erdfelt Copyright (c) David Brownell Copyright (c) Aurelien Jarno
Util-Linux 2.28.1	GPL-2.0 LGPL-2.1	Copyright (c) 2014 Sami Kerola <kerolasa@iki.fi> Copyright (c) 1995,1996,1997,1998,1999,2000,2008 Theodore Ts'o. Copyright (c) 2009 Karel Zak <kzak@redhat.com> Copyright (c) 2009 Red Hat, Inc. Copyright (c) 2000, 2001, 2003 Theodore Ts'o Copyright (c) 2001 Andreas Dilger
vCard/vCal Parser C Library 1.0	MPL-1.1	
videolan-x264	GPL-2.0	Copyright (c) 2003-2014 x264 project
vsomeip 2.5.2	MPL-2.0	Copyright (C) 2015-2016, Bayerische Motoren Werke Aktiengesellschaft (BMW AG)
Wireless Tools 30	GPL-2.0	Copyright (c) 1997-2004 Jean Tourrilhes <jt@hpl.hp.com>

The source code for the above may be obtained free of charge from LG Electronics, Inc. at <https://opensource.lge.com>. LG Electronics, Inc. will also provide open source code to you on CD-ROM for a charge covering the cost of performing such distribution (such as the cost of media, shipping, and handling) upon email request to opensource@lge.com. This offer is valid for a period of three years after our last shipment of this product. This offer is valid to anyone in receipt of this information.

Please be informed that LG Electronics, Inc. product may contain open source software listed in the tables below.

Open Source	License	Copyright
action-core 0.1.1	Apache-2.0	Copyright (c) 2010-2011 Ning, Inc.
alsa-state 0.2.0	MIT	Copyright (c) 2007 Matthias Hentges <devel@hentges.net>
Android Open Source Project	Apache-2.0	Copyright (c) 2005-2016, The Android Open Source Project
android-external-dhccpd	BSD-like License (android-external-dhccpd)	
android-external-dhccpd-6.8.2	BSD-like License (android-external-dhccpd)	Copyright (c) 2006-2015 Roy Marples <roy@marples.name> Copyright (c) 2004,2007 by Internet Systems Consortium, Inc. ("ISC") Copyright (c) 1996-2003 by Internet Software Consortium Copyright (c) 1991, 1993 The Regents of the University of California. Copyright (c) 2008, Damien Miller <djm@openbsd.org> Copyright (c) 1996 David Mazieres <dm@lcs.mit.edu>. Copyright (c) 2005 Colin Percival
android-external-mdnsresponder	Apache-2.0	
android-external-safe-iop	ISC	Copyright (c) 2007,2008 Will Drewry <redpig@dataspill.org> Copyright (c) 2008, Google Inc.
android-hardware-broadcom-wlan	Apache-2.0 BSD-3-Clause ISC	Copyright (C) 2008 The Android Open Source Project Copyright (c) 2005-2010, The Android Open Source Project Copyright (c) 2002-2010, Jouni Malinen <j@w1.fi> Copyright (c) 2003-2004, Instant802 Networks, Inc. Copyright (c) 2005-2006, Devicescape Software, Inc. Copyright (c) 2007, Johannes Berg <johannes@sipsolutions.net> Copyright (c) 2009-2010, Atheros Communications Copyright (C) 1999-2013, Broadcom Corporation
android-system-core	Apache-2.0	Copyright (c) 2010 The Android Open Source Project Copyright (c) 2005-2008 The Android Open Source Project Copyright (c) 1999-2006 The Apache Software Foundation Copyright (c) 2005,2006 The Apache Software Foundation. Copyright (c) 2007 Nuance Communications Copyright (c) 1998 - 2009 PacketVide Copyright (c) 2002-2008 by John Cowan. Copyright (c) 2003-2010 VisualOn Copyright (c) 2004-2010 NXP Software Copyright (c) 2010 The Android Open Source Project
android-system-core-base 9.0	Apache-2.0	Copyright (C) 2016 The Android Open Source Project
android-system-core-fastboot	BSD-2-Clause	Copyright (c) 2008 The Android Open Source Project
android-system-core-include-mincrypt 4.2.2	BSD-3-Clause	Copyright (c) 2005-2013 The Android Open Source Project
android-system-netd	Apache-2.0	Copyright (c) 2016 The Android Open Source Project
android-tools 4.2.2	Apache-2.0 BSD-2-Clause BSD-3-Clause	Copyright (c) 2006-2012, The Android Open Source Project Copyright (c) 2006, Brian Swetland <swetland@frotz.net> Copyright (c) 2012, Linaro Ltd. Copyright (c) 2012, Laszlo Boszormenyi (GCS) <gcs@debian.hu> Copyright (c) 2007, Google Inc.
ANGLE	BSD-3-Clause	Copyright (c) 2018 The ANGLE Project Authors.

Anti-Grain Geometry 2.4	Anti-Grain Geometry Public License	Copyright (c) 2002-2005 Maxim Shemanarev (http://www.antigrain.com)
assimp 3.1.1	BSD-3-Clause	Copyright (c) 2006-2016, assimp team Poly2Tri Copyright (c) 2009-2010, Poly2Tri Contributors
BIND 9.10.6	ISC	Copyright (c) 1996-2003, 2007, 2012, Internet Software Consortium.
Boost 1.62.0	BSL-1.0	Copyright (c) 1998-2005 Beman Dawes, David Abrahams, Copyright (c) 2004-2007 Rene Rivera.
Boost	BSL-1.0	Copyright (c) 1998-2005 Beman Dawes, David Abrahams, Copyright (c) 2004-2007 Rene Rivera.
bzip2 1.0.6	bzip2-1.0.6	Copyright (c) 1996-2010 Julian Seward < jseward@bzip.org >
c-ares 1.14.0	MIT-like License (c-ares)	Copyright (c) 2007 - 2018, Daniel Stenberg with many contributors, see AUTHORS file. Copyright (c) 1998 by the Massachusetts Institute of Technology.
can-utils	BSD-3-Clause	Copyright (c) 2002-2008 Volkswagen Group Electronic Research
capstone 3.0.5	BSD-3-Clause	Copyright (c) 2013, COSEINC.
Catch2	BSL-1.0	Copyright (c) 2018 Two Blue Cubes Ltd. All rights reserved.
compact_enc_det 1.0.2	Apache-2.0	Copyright (c) 2016 Google Inc.
curl 7.66.0	curl	Copyright (c) 1998 - 2017, Daniel Stenberg
curl 7.40.0	curl	Copyright (c) 1996 - 2015, Daniel Stenberg, < daniel@haxx.se >.
dbus 1.10.20	AFL-2.1	Copyright (c) 2002-2007, Red Hat, Inc.
dbus 1.10.10	AFL-2.1	
dbus-glib 0.108	AFL-2.1	Copyright (c) 1994-2014 Free Software Foundation, Inc. Copyright (c) 2005 Red Hat, Inc.
dbus-glib 0.106	AFL-2.1	Copyright (c) 2008 David Zeuthen < davidz@redhat.com > Copyright (c) 2002, 2003 CodeFactory AB Copyright (c) 2004 Ximian, Inc. Copyright (c) 2003, 2004, 2005 Red Hat, Inc. Copyright (c) 2005 Nokia
dbus-python 1.2.4	MIT	Copyright (c) 2005-2008 Collabora Ltd. < http://www.collabora.co.uk/ >
dropbear 2017.75	MIT	Copyright (c) 2002-2014, Matt Johnston Portions copyright (c) 2004, Mihnea Stoenescu
e2fsprogs 1.43	MIT-like License (e2fsprogs)	Copyright (c) 1995 Gadi Oxman Copyright (c) 1995-2010, Theodore Ts'o Copyright (c) 1999 Andrea Arcangeli < andrea@suse.de > Copyright (c) 2000 Andreas Gruenbacher, < a.gruenbacher@computer.org > Copyright (c) 2002 David Woodhouse < dwmw2@infradead.org > Copyright (c) 1998-2000 Red Hat, Inc Copyright (c) 2014 Google Inc. Copyright (c) 1992-1995 Remy Card (card@masi.ibp.fr) Laboratoire MASI - Institut Blaise Pascal Universite Pierre et Marie Curie (Paris VI) Copyright (c) 2014 Oracle. Copyright (c) 1999, 2001 Andreas Dilger (adilger@turbolinux.com) Copyright (c) 2004 Kay Sievers < kay.sievers@vrfy.org > Copyright (c) 1995-1999, 2000-2003 Free Software Foundation, Inc. Copyright (c) 1986-1989, MIT Information Systems and the MIT Student Information Processing Board.

EasyLoggingPP	MIT	Copyright (c) 2012-2018 Muflihun Labs Copyright (c) 2012-2018 @abumusamq
expat 2.2.8	MIT	Copyright (c) 1998-2000 Thai Open Source Software Center Ltd and Clark Cooper Copyright (c) 2000-2017 Expat maintainers
FFT	FFT License	Copyright (c) 1996-2001 Takuya OOURA
file 5.36	BSD-like License (file)	Copyright (c) Ian F. Darwin 1986-1995. Software written by Ian F. Darwin and others;
flac 1.3.1	BSD-3-Clause	Copyright (c) 2011-2014 Xiph.Org Foundation Copyright (c) 2000-2009 Josh Coalson Copyright (c) 1998 Todd C. Miller <Todd.Miller@courtesan.com> Copyright (c) 2002-2009 Daisuke Shimamura Copyright (c) 1998-2000 Peter Alm, Mikael Alm, Olle Hallnas, Thomas Nilsson and 4Front Technologies Copyright (c) 2000-2002 Jerome Couderc <j.couderc@ifrance.com> Copyright (c) 1999-2001 Håvard Kvålen <havardk@xmms.org> Copyright (c) 2001 Edmund Grimley Evans <edmund@rano.org> Copyright (c) 2002 John Edwards Additional code Magnus Holmgren and Gian-Carlo Pascutto Copyright (c) 2001 Peter Harris <peter.harris@hummingbird.com> Copyright (c) 2001 David Robinson and Glen Sawyer Copyright (c) 1987-1999 Free Software Foundation, Inc. Copyright (c) 2003 Philip Jägenstedt Copyright (c) 2000-2001 Robert Leslie
flex 2.6.0	BSD-like License (flex)	Copyright (c) 2001, 2002, 2003, 2004, 2005, 2006, 2007 The Flex Project. Copyright (c) 1990, 1997 The Regents of the University of California.
fontconfig 2.12.1	MIT-like License (fontconfig)	Copyright (c) 2000,2001,2002,2003,2004,2006,2007 Keith Packard Copyright (c) 2005 Patrick Lam Copyright (c) 2009 Roozbeh Pournader Copyright (c) 2008,2009 Red Hat, Inc. Copyright (c) 2008 Danilo Šegan Copyright (c) 2012 Google, Inc.
freetype 2.6.5	FTL	Copyright (c) 2006-2016 by David Turner, Robert Wilhelm, and Werner Lemberg
Google C++ Mocking Framework 1.7.0	BSD-3-Clause	Copyright (c) 2008, Google Inc.
googlecartographer-cartographer	Apache-2.0	Copyright (c) 2016 The Cartographer Authors
googletest 1.7.0	BSD-3-Clause	Copyright (c) 2008, Google Inc.
gpsd 3.14	BSD-3-Clause	Copyright (c) GPSD project. Copyright (c) 2005, Eric S. Raymond. Copyright (c) 1997-2002, Remco Treffkorn, and others
HarfBuzz 1.7.5	MIT-like License (HarfBuzz)	-
hostapd 2.9	BSD-3-Clause	Copyright (c) 2002-2019, Jouni Malinen <j@w1.fi> and contributors
icu 57.1	ICU	Copyright (c) 1995-2016 International Business Machines Corporation and others Copyright (c) 1991-2016 Unicode
iperf 3.1.3	BSD-like License (iperf)	Copyright (c) 2014-2016, The Regents of the University of California, through Lawrence Berkeley National Laboratory (subject to receipt of any required approvals from the U.S. Dept. of Energy).



iperf 2.0.10	NCSA	Copyright (c) 1999-2007, The Board of Trustees of the University of Illinois
Itzam/C 6.0.4	BSD-2-Clause	Copyright (c) 2011 Scott Robert Ladd
iw 4.7	ISC	Copyright (c) 2007, 2008 Johannes Berg Copyright (c) 2007 Andy Lutomirski Copyright (c) 2007 Mike Kershaw Copyright (c) 2008-2009 Luis R. Rodriguez
Jansson 2.9	MIT	Copyright (c) 2009-2016 Petri Lehtinen <petri@digip.org>
jpeg 6b	IJG	copyright (C) 1991-1998, Thomas G. Lane.
jpeg	IJG	Copyright (C) 1992-1997, Thomas G. Lane.
json-c 0.12	MIT	Copyright (c) 2009-2012 Eric Haszlakiewicz Copyright (c) 2004, 2005 Metaparadigm Pte Ltd
JsonCPP 1.8.3	MIT	Copyright (c) 2007-2010 Baptiste Lepilleur and The JsonCpp Authors
JsonCPP 1.8.0	MIT	Copyright (c) 2007-2010 Baptiste Lepilleur
JsonCPP 1.7.1	MIT	Copyright (c) 2007-2010 Baptiste Lepilleur
JsonCPP 1.6.2	MIT	Copyright (c) 2007-2010 Baptiste Lepilleur
krb5 1.16	MIT-like License (krb5)	
less 481	Less	Copyright (c) 1984-2016 Mark Nudelman
libarchive 3.4.0	BSD-2-Clause	Copyright (c) 2003-2007 Tim Kientzle Copyright (c) 2012 Michihiro NAKAJIMA
libatomic_ops 7.4.4	MIT	Copyright (c) 1999-2003 by Hewlett-Packard Company. Copyright (c) 1991-1994 by Xerox Corporation. Copyright (c) 1996-1999 by Silicon Graphics. Copyright (C) 2016 Marek Vasut <marex@denx.de>

libbsd 0.8.3	BSD-2-Clause BSD-3-Clause BSD-4-Clause ISC MIT	<p>Copyright (c) 1994, 1997-2000, 2002, 2008, The NetBSD Foundation, Inc. Copyright (c) 1998, M. Warner Losh Copyright (c) 1997, Christos Zoulas. Copyright (c) 2001, Dima Dorfman. Copyright (c) 2001, FreeBSD Inc. Copyright (c) 2002, Niels Provos Copyright (c) 2002, Thomas Moestl Copyright (c) 2005, Colin Percival Copyright (c) 2005, Pawel Jakub Dawidek Copyright (c) 2007, Dag-Erling Coidan Smørgrav Copyright (c) 2007, Dag-Erling Coidan Smørgrav Copyright (c) 2007, Eric Anderson Copyright (c) 2007, Pawel Jakub Dawidek Copyright (c) 2009, Advanced Computing Technologies LLC Copyright (c) 2011, Guillem Jover</p> <p>Copyright (c) 2004-2006, 2008-2015, Guillem Jover Copyright (c) 2005, Hector Garcia Alvarez Copyright (c) 2005, Aurelien Jarno Copyright (c) 2006, Robert Millan Copyright (c) 1980, 1982, 1986, 1989-1994, The Regents of the University of California. Copyright (c) 2001, Mike Barcroft Copyright (c) UNIX System Laboratories, Inc. Copyright (c) 1995-1996, Peter Wemm Copyright (c) 2002, Networks Associates Technology, Inc. Copyright (c) 1997, Niels Provos Copyright (c) 2001, Christopher G. Demetriou Copyright (c) 2004, Ted Unangst and Todd Miller Copyright (c) 1996, David Mazieres Copyright (c) 1998, 2000-2002, 2004-2005, 2007, 2010, 2012-2014, Todd C. Miller Copyright (c) 2008, Damien Miller Copyright (c) 2008, Otto Moerbeek Copyright (c) 2013, Markus Friedl Copyright (c) 2014, Bob Beck Copyright (c) 2014, Brent Cook Copyright (c) 2014, Pawel Jakub Dawidek Copyright (c) 2014, Theo de Raadt Copyright (c) 2015, Michael Felt Copyright (c) 2015, Guillem Jover Copyright (c) 2010, William Ahern Copyright (c) 2012, Guillem Jover</p>
libcap 2.25	BSD-3-Clause	Copyright (c) The Regents of the University of California.
libevent 2.1.8	MIT	Copyright (c) 2013 Red Hat, Inc.
libevent 2.1.8	BSD-3-Clause	<p>Copyright (c) 2000-2007 Niels Provos <provos@citi.umich.edu> Copyright (c) 2007-2010 Niels Provos and Nick Mathewson log.c: Copyright (c) 2000 Dug Song <dugsong@monkey.org> Copyright (c) 1993 The Regents of the University of California.</p> <p>strlcpy.c: Copyright (c) 1998 Todd C. Miller <todd.miller@courtesan.com></p> <p>win32select.c: Copyright (c) 2003 Michael A. Davis <mike@datanerds.net></p> <p>evport.c: Copyright (c) 2007 Sun Microsystems</p> <p>ht-internal.h: Copyright (c) 2002 Christopher Clark</p> <p>minheap-internal.h: Copyright (c) 2006 Maxim Yegorushkin <maxim.yegorushkin@gmail.com></p>

libevent 2.0.22	BSD-3-Clause MIT-like License (OpenBSD)	Copyright (c) 2000-2007 Niels Provos <provos@citi.umich.edu> Copyright (c) 2007-2012 Niels Provos and Nick Mathewson Copyright (c) 2000 Dug Song <dugsong@monkey.org> Copyright (c) 1993 The Regents of the University of California, Copyright (c) 1998 Todd C. Miller <todd.miller@courtesan.com> Copyright (c) 2003 Michael A. Davis <mike@datanerds.net> Copyright (c) 2007 Sun Microsystems Copyright (c) 2002 Christopher Clark Copyright (c) 2006 Maxim Yegorushkin <maxim.yegorushkin@gmail.com> Copyright (c) 1996, David Mazieres <dm@uun.org> Copyright (c) 2008, Damien Miller <djm@openbsd.org>
libffi 3.2.1	MIT	Copyright (c) 1996-2014 Anthony Green, Red Hat, Inc and others. Copyright (c) 2011 Anthony Green Copyright (c) 2008 Red Hat, Inc. Copyright (c) 2006 Free Software Foundation, Inc. Copyright (c) 2003-2004 Randolph Chung <tausq@debian.org>
libGuarded 1.1.0	BSD-2-Clause	Copyright (c) 2016, Ansel Sermersheim
libinput 1.5.0	MIT	Copyright (c) 2006-2009 Simon Thum Copyright (c) 2008-2012 Kristian Høgsberg Copyright (c) 2010-2012 Intel Corporation Copyright (c) 2010-2011 Benjamin Franzke Copyright (c) 2011-2012 Collabora, Ltd. Copyright (c) 2013-2014 Jonas Ådahl Copyright (c) 2013-2015 Red Hat, Inc.
libjpeg-turbo 1.5.0	IJG	
libnfsidmap 0.25	BSD-3-Clause	Copyright (c) 2004 The Regents of the University of Michigan. Copyright (c) Marius Aamodt Eriksen <marius@umich.edu> Copyright (c) J. Bruce Fields <bfields@umich.edu>
libogg 1.3.2	BSD-3-Clause	Copyright (c) 2002, Xiph.Org.
libpcap 1.9.1	BSD-3-Clause	
libphonenumber 8.10.16	Apache-2.0	Copyright (c) 2011 The Libphonenumber Authors
libphonenumber	Apache-2.0	Copyright (c) 2009 The Libphonenumber Authors
libpng 1.6.14	Libpng	Copyright (c) 1998-2015 Glenn Randers-Pehrson Copyright (c) 1996, 1997 Andreas Dilger Copyright (c) 1995, 1996 Guy Eric Schalnat, Group 42, Inc.
libpng 1.2.8	Libpng	Copyright (c) 2000, 2004 Cosmin Truta. Copyright (c) 1998-2004 Glenn Randers-Pehrson. Copyright (c) 1996-1997 Andreas Dilger. Copyright (c) 1995-1996 Guy Eric Schalnat, Group 42, Inc.
libpng 1.2.6	Libpng	Copyright (c) 1998-2014 Glenn Randers-Pehrson Copyright (c) 1996, 1997 Andreas Dilger Copyright (c) 1995, 1996 Guy Eric Schalnat, Group 42, Inc.
libpng 1.2.57	Libpng	Copyright (c) 1998-2002,2004,2006-2015 Glenn Randers-Pehrson Copyright (c) 1996, 1997 Andreas Dilger Copyright (c) 1995, 1996 Guy Eric Schalnat, Group 42, Inc.
libpng 1.6.37	libpng-2.0	Copyright (c) 1995-2019 The PNG Reference Library Authors. Copyright (c) 2018-2019 Cosmin Truta. Copyright (c) 2000-2002, 2004, 2006-2018 Glenn Randers-Pehrson. Copyright (c) 1996-1997 Andreas Dilger. Copyright (c) 1995-1996 Guy Eric Schalnat, Group 42, Inc.
libtheora 1.1.1	BSD-3-Clause	Copyright (C) 2002-2009 Xiph.org Foundation

libtirpc 1.1.4	BSD-3-Clause	Copyright (c) 1984-1992, 2009 Sun Microsystems, Inc.
libunwind 1.2	MIT	Copyright (c) 2002 Hewlett-Packard Co.
libusb-compat 0.1.5	BSD-3-Clause	Copyright (c) 2000-2003 Johannes Erdfelt <johannes@erdfelt.com>
libuuid 1.0.3	BSD-3-Clause	Copyright (c) 1996-1999, Theodore Ts'o.
libvcard 1.0.0	BSD-3-Clause	Copyright (c) 2010, Emanuele Bertoldi (Card Tech srl)
libvorbis 1.3.5	BSD-3-Clause	Copyright (c) 2002-2015 Xiph.org Foundation
libwebp 1.1.0	BSD-3-Clause	Copyright (c) 2010-2018 Google Inc.
libwebp 0.5.1	BSD-3-Clause	Copyright (c) 2010, Google Inc.
libxkbcommon 0.6.1	MIT-like License (libxkbcommon)	
libxml2 2.9.4	MIT	Copyright (c) 1998-2012 Daniel Veillard, Copyright (c) 1998, 2000, 2012 Bjorn Reese, Copyright (c) 2000 Gary Pennington.
libxml2 2.4.26	MIT-like License (libxml2)	Copyright (c) 1998-2002 Daniel Veillard
libxslt 1.1.32	X11	Copyright (C) 2001-2002 Thomas Broyer, Charlie Bozeman and Daniel Veillard.
libzen 0.4.34	Zlib	Copyright (c) 2002-2014, MediaArea.net SARL.
Linux-PAM 1.3.0	BSD-3-Clause	Copyright (c) YEAR Linux-PAM Project Copyright (c) 2005-2010, Thorsten Kukuk <kukuk@suse.de> Copyright (c) 2005-2009, Red Hat, Inc.
Isosf 4.89	MIT-like License (Isosf)	Copyright (c) 1994 Purdue Research Foundation, West Lafayette, Indiana 47907.
mDNSResponder 765.20.4	Apache-2.0 BSD-3-Clause NICTA Public Software Licence 1.0	Copyright (c) 1997-2011, Apple Computer, Inc. Copyright (c) 1995-1998, Eric Young Copyright (c) 1995-1999, WIDE Project. Copyright (c) 1997-2011, Apple Computer, Inc. Copyright (c) 2004, National ICT Australia Ltd
MediaInfoLib 0.7.91	BSD-2-Clause	Copyright (c) 2002-2014 MediaArea.net SARL.
Mesa3D	MIT	Copyright (C) 2007 VMware, Inc. Copyright (C) 2012 Intel Corporation Copyright (C) 1999-2008 Brian Paul Copyright (C) 2010 LunarG Inc. Copyright (C) 2013 Rob Clark <robclark@freedesktop.org>
mtdev 1.1.5	MIT	Copyright (C) 2010 Henrik Rydberg Copyright (C) 2010 Canonical Ltd.
NamedType 1.0.0	MIT	Copyright (c) 2017 Jonathan Boccara
ncurses 6.1	MIT-like License (ncurses)	Copyright (c) 1998-2017,2018 Free Software Foundation, Inc.
Ne10 1.2.1	BSD-3-Clause	Copyright (c) 2012-15 ARM Limited and Contributors.
netcat-openbsd 1.105	BSD-2-Clause BSD-3-Clause	Copyright (c) 2006 Damien Miller Copyright (c) 1995,1999 Theo de Raadt Copyright (c) 2005 Anil Madhavapeddy Copyright (c) 2004, 2005 Damien Miller Copyright (c) 2001 Eric Jackson <ericj@monkey.org> Copyright (c) 1999 Niklas Hallqvist Copyright (c) 1996 David Sacerdote



nlohmann-json 3.6.1	MIT	Copyright (c) 2013-2019 Niels Lohmann
nlohmann-json 3.2.0	MIT	Copyright (c) 2013-2018 Niels Lohmann
nlohmann-json 3.1.2	MIT	Copyright (c) 2013-2018 Niels Lohmann
ntp 4.2.8p9	BSD-2-Clause NTP	Copyright (c) Network Time Foundation 2011-2015 Copyright (c) University of Delaware 1992-2015
opencv 4.3.0	BSD-3-Clause	Copyright (c) 2000-2008, Intel Corporation Copyright (c) 2009, Willow Garage Inc. Copyright (c) 2013, OpenCV Foundation
OpenGL	SGI-B-2.0	
openssh 7.6p1	OpenSSH License	
openssl 1.0.2o	OpenSSL	Copyright (c) 1998-2015 The OpenSSL Project Copyright (c) 1995-1998 Eric A. Young, Tim J. Hudson
openssl 1.0.2h	OpenSSL	Copyright (c) 1998-2016 The OpenSSL Project.
openssl 1.0.1j	OpenSSL	
OpenVG 1.0.1	MIT	Copyright (c) 2007 The Khronos Group Inc.
Opus 1.1.2	BSD-3-Clause	Copyright (c) 2001-2011 Xiph.Org, Skype Limited, Octasic, Copyright (c) 2001-2011 Jean-Marc Valin, Timothy B. Terriberry, Copyright (c) 2001-2011 CSIRO, Gregory Maxwell, Mark Borgerding, Copyright (c) 2001-2011 Erik de Castro Lopo
Opus 0.2.1	BSD-3-Clause	Copyright (c) 1994-2013 Xiph.Org Foundation and contributors Copyright (c) 2017 Jean-Marc Valin
orc 0.4.25	BSD-2-Clause BSD-3-Clause	Copyright (c) 2002 - 2009 David A. Schleefer <ds@schleefer.org> Copyright (c) 1997 - 2002, Makoto Matsumoto and Takuji Nishimura
OSSP-uuid 1.6.2	MIT-like License (OSSP- uuid)	Copyright (c) 2004-2008 Ralf S. Engelschall <rse@engelschall.com> Copyright (c) 2004-2008 The OSSP Project < http://www.ossip.org/ >
pcre 8.43	BSD-3-Clause	Copyright (c) 1997-2019 University of Cambridge Copyright (c) 2009-2019 Zoltan Herczeg Copyright (c) 2003, 2005, 2007-2012, Google Inc.
perl 5.22.1	Artistic-1.0-Perl	Copyright (C) 1993-2017 by Larry Wall and others.
persistence-client-library 1.0.0	MIT	Copyright (C) 2016 Mentor Graphics, (c) copyright 2012 Company XS Embedded GmbH
pip 8.1.2	MIT	Copyright (c) 2008-2016 The pip developers
Pipe Viewer	Artistic-2.0	
Pixman 0.9.6	MIT	

Pixman 0,34.0	MIT	Copyright (c) 1987, 1988, 1989, 1998 The Open Group Copyright (c) 1987, 1988, 1989 Digital Equipment Corporation Copyright (c) 1999, 2004, 2008 Keith Packard Copyright (c) 2000 SuSE, Inc. Copyright (c) 2000 Keith Packard, member of The XFree86 Project, Inc. Copyright (c) 2004, 2005, 2007, 2008, 2009, 2010 Red Hat, Inc. Copyright (c) 2004 Nicholas Miell Copyright (c) 2005 Lars Knoll & Zack Rusin, Trolltech Copyright (c) 2005 Trolltech AS Copyright (c) 2007 Luca Barbato Copyright (c) 2008 Aaron Plattner, NVIDIA Corporation Copyright (c) 2008 Rodrigo Kumpera Copyright (c) 2008 André Tupinambá Copyright (c) 2008 Mozilla Corporation Copyright (c) 2008 Frederic Plourde Copyright (c) 2009, Oracle and/or its affiliates. Copyright (c) 2009, 2010 Nokia Corporation
pointercal 0.0	MIT	
popt 1.16	X11	Copyright (c) 1998, Red Hat Software
portmap 6.0	BSD-4-Clause	Copyright (c) 1990 The Regents of the University of California.
ppp 2.4.7	BSD-like License (ppp)	Copyright (c) 1995 Pedro Roque Marques.
Protocol Buffers 3.5.1	BSD-3-Clause	Copyright (c) 2008, Google Inc.
python 3.5.2	Python-2.0	
python 2.7.12	Python-2.0	
python-cson	MIT	Copyright (c) 2014 gt3389b
python-pam 1.8.2	MIT	Copyright (c) 2007 Chris AtLee
QR Code generator library 1.6.0	MIT	Copyright (c) 2016 Project Nayuki
QR Code generator library 1.0.0	MIT	Copyright (c) 2016 Project Nayuki
quota 4.03	BSD-4-Clause	Copyright (c) 1980, 1990 Regents of the University of California. Copyright (C) 2000, 2001 Silicon Graphics, Inc. [SGI]
range-v3 0.3.6	BSL-1.0	
rapidjson Parser 1.1.0	MIT	Copyright (c) 2015 THL A29 Limited, a Tencent company, and Milo Yip.
rapidjson Parser	MIT	Copyright (C) 2015 THL A29 Limited, a Tencent company, and Milo Yip.
rpcbind 0.2.3	BSD-3-Clause	Copyright (c) 2005 Bull S.A.
run-postinsts 1.0	MIT	Copyright (c) 2007 Openedhand Ltd.
RxCpp	Apache-2.0	Copyright (c) Microsoft Open Technologies, Inc.
scws 1.2.3	BSD-3-Clause	Copyright (c) 2010-2013, hightman
setuptools 22.0.5	MIT	Copyright (C) 2016 Jason R Coombs <jaraco@jaraco.com>

shadow 4.2.1	BSD-2-Clause BSD-3-Clause	Copyright (c) 1989 - 1994, Julianne Frances Haugh Copyright (c) 1996 - 2001, Marek Michalkiewicz Copyright (c) 2001 - 2006, Tomasz Kloczko Copyright (c) 2004 The FreeBSD Project Copyright (c) 1997, Guy Maor <maor@ece.utexas.edu> Copyright (c) 2007 - 2013, Nicolas François Copyright (c) 1991 - 1993, Chip Rosenthal
spdlog 1.0.0	MIT	Copyright (c) 2016 Gabi Melman,
speex 1.2rc2	BSD-3-Clause	Copyright (c) 2002-2008, Xiph.org Foundation Copyright (c) 2002-2008, Jean-Marc Valin Copyright (c) 2005-2007, Analog Devices Inc. Copyright (c) 2005-2008, Commonwealth Scientific and Industrial Research Organisation (CSIRO) Copyright (c) 1993, 2002, 2006, David Rowe Copyright (c) 2003, EpicGames Copyright (c) 1992-1994, Jutta Degener, Carsten Bormann
SpeexDSP 1.2	BSD-3-Clause	Copyright (c) 2002-2008 Xiph.org Foundation Copyright (c) 2002-2008 Jean-Marc Valin Copyright (c) 2005-2007 Analog Devices Inc. Copyright (c) 2005-2008 Commonwealth Scientific and Industrial Research Organisation (CSIRO) Copyright (c) 1993, 2002, 2006 David Rowe Copyright (c) 2003 EpicGames Copyright (c) 1992-1994 Jutta Degener, Carsten Bormann
stlport 4.0	STLport License	
strace 4.13	BSD-3-Clause	Copyright (c) 1991, 1992 Paul Kranenburg <pk@cs.few.eur.nl> Copyright (c) 1993 Branko Lankester <branko@hacktic.nl> Copyright (c) 1993 Ulrich Pegelow <pegelow@moorea.uni-muenster.de> Copyright (c) 1995, 1996 Michael Elizabeth Chastain <mec@duracef.shout.net> Copyright (c) 1993, 1994, 1995, 1996 Rick Sladkey <jrs@world.std.com> Copyright (C) 1998-2001 Wichert Akkerman <wakkerma@deephackmode.org>
sudo 1.8.22	MIT-like License (sudo)	Copyright (c) 1994-1996, 1998-2015, Todd C. Miller <Todd.Miller@courtesan.com> Copyright (c) 2001, Emin Martinian Copyright (c) 2008, Otto Moerbeek <otto@drijf.net> Copyright (c) 1989, 1990, 1991, 1993, The Regents of the University of California. Copyright (c) 2011, VMware, Inc. Copyright (c) 2000, The NetBSD Foundation, Inc. Copyright (c) 1996, Internet Software Consortium. Copyright (C) 1995-2017, Jean-loup Gailly and Mark Adler
systemd-compat-units	MIT	
tcp-wrappers 7.6	BSD-like License (tcp-wrappers)	Copyright (c) 1995 by Wietse Venema,
tcpdump 4.9.2	BSD-3-Clause	Copyright (c) 1998-2015, The Tcpdump Project
tftp-hpa 5.2	BSD-3-Clause	Copyright (c) 1983, 1990, 1993, 1994, The Regents of the University of California. Copyright (c) 2001, H. Peter Anvin Copyright (c) 2011, Intel Corporation
tinyxml 2.6.1	Zlib	Copyright (c) 2000-2002 Lee Thomason (www.grinninglizard.com)
tremor	BSD-3-Clause	Copyright (c) 2002, Xiph.org Foundation
unzip 6.0	Info-ZIP	Copyright (c) 1990-2009 Info-ZIP.

util-macros 1.19.0	MIT-like License (util-macros)	Copyright (c) 2005 Red Hat, Inc. Copyright (c) 2005, 2006, Oracle and/or its affiliates.
VASer 0.42	BSD-3-Clause	Copyright (c) 2011-2016 Tsang Hao Fung (Chris Tsang) tyt2y3@gmail.com
Vulkan-LoaderAndValidationLayers 1.1.73.0	Apache-2.0 BSD-2-Clause BSD-3-Clause MIT	Copyright (c) 2015-2018 The Khronos Group Inc. Copyright (c) 2014-2018 Valve Corporation Copyright (c) 2014-2018 LunarG, Inc. Copyright (c) 2015-2017 Google, Inc. Copyright (c) 2012-2016, Yann Collet. Copyright (c) 2008, Google Inc. Copyright 2000-2009 Kitware, Inc., Insight Software Consortium Copyright (c) 2011 Fredrik Höglund <fredrik@kde.org> Copyright (c) 2008 Helio Chissini de Castro, <helio@kde.org> Copyright (c) 2007 Matthias Kretz, <kretz@kde.org> Copyright (c) 2005 - 2014 G-Truc Creation (www.g-truc.net) Copyright (c) 2009 Dave Gamble
Wayland 1.8.91 or later	MIT	Copyright (c) 2008-2012 Kristian Høgsberg Copyright (c) 2010-2012 Intel Corporation Copyright (c) 2011 Benjamin Franzke Copyright (c) 2012 Collabora, Ltd.
Wayland 1.13.0	MIT	Copyright (c) 2008-2012 Kristian Høgsberg Copyright (c) 2010-2012 Intel Corporation Copyright (c) 2011 Benjamin Franzke Copyright (c) 2012 Collabora, Ltd.
wayland-ivi-extension 1.13.0	Apache-2.0	Copyright (c) 2010,2011, BMW Car IT GmbH Copyright (c) 2011, DENSO CORPORATION and Robert Bosch Car Multimedia GmbH
wcelibcex	MIT	Created by Stéphane Dunand (sdunand@sirap.fr)
Weston 2.0.0	MIT	Copyright (c) 2008-2012 Kristian Høgsberg Copyright (c) 2010-2012 Intel Corporation Copyright (c) 2010-2011 Benjamin Franzke Copyright (c) 2011-2012 Collabora, Ltd. Copyright (c) 2010 Red Hat <mjg@redhat.com>
weston-init 1.0	MIT	
wpa_supplicant 2.5	BSD-3-Clause	Copyright (c) 2002-2015, Jouni Malinen <j@w1.fi> and contributors
xkeyboard-config 2.18	MIT-like License (xkeyboard-config)	Copyright (c) 1996, Joseph Moss Copyright (c) 2002-2007, Free Software Foundation, Inc. Copyright (c) 2003-2004, Dmitry Golubev Copyright (c) 2004, Gregory Mokhin Copyright (c) 2006, Erdal Ronahi Copyright (c) 1996, Digital Equipment Corporation Copyright (c) 1996, 1998 The Open Group Copyright (c) 2004-2005, Sun Microsystems, Inc. Copyright (c) 1996, Silicon Graphics Computer Systems, Inc. Copyright (c) 1996, X Consortium Copyright (c) 2004, 2006, Ævar Arnfjörð Bjarmason
xxHash - Fast Hash algorithm	BSD-2-Clause	Copyright (c) 2012-2014, Yann Collet.
zip 3.0	Info-ZIP	
zlib 1.2.8	Zlib	Copyright (c) 1995-2013 Jean-loup Gailly and Mark Adler
zlib 1.2.3	Zlib	Copyright (c) 1995-2013 Jean-loup Gailly and Mark Adler
zlib 1.2.11	Zlib	Copyright (c) 1995-2017 Jean-loup Gailly and Mark Adler



-	MIT	Copyright (c) 1991, 2000, 2001 by Lucent Technologies
-	Zlib	Copyright (c) 1999, 2000, 2002 Aladdin Enterprises.

IJG Attribution

This software is based in part on the work of the Independent JPEG Group.

OpenSSL Attribution

This product includes software developed by the OpenSSL Project for use in the OpenSSL Toolkit. (<http://www.openssl.org/>)

MIT

Permission is hereby granted, free of charge, to any person obtaining a copy of this software and associated documentation files (the "Software"), to deal in the Software without restriction, including without limitation the rights to use, copy, modify, merge, publish, distribute, sublicense, and/or sell copies of the Software, and to permit persons to whom the Software is furnished to do so, subject to the following conditions:

The above copyright notice and this permission notice shall be included in all copies or substantial portions of the Software.

THE SOFTWARE IS PROVIDED "AS IS", WITHOUT WARRANTY OF ANY KIND, EXPRESS OR IMPLIED, INCLUDING BUT NOT LIMITED TO THE WARRANTIES OF MERCHANTABILITY, FITNESS FOR A PARTICULAR PURPOSE AND NONINFRINGEMENT. IN NO EVENT SHALL THE AUTHORS OR COPYRIGHT HOLDERS BE LIABLE FOR ANY CLAIM, DAMAGES OR OTHER LIABILITY, WHETHER IN AN ACTION OF CONTRACT, TORT OR OTHERWISE, ARISING FROM, OUT OF OR IN CONNECTION WITH THE SOFTWARE OR THE USE OR OTHER DEALINGS IN THE SOFTWARE.

Zlib

zlib License

This software is provided 'as-is', without any express or implied warranty. In no event will the authors be held liable for any damages arising from the use of this software.

Permission is granted to anyone to use this software for any purpose, including commercial applications, and to alter it and redistribute it freely, subject to the following restrictions:

1. The origin of this software must not be misrepresented; you must not claim that you wrote the original software. If you use this software in a product, an acknowledgment in the product documentation would be appreciated but is not required.
2. Altered source versions must be plainly marked as such, and must not be misrepresented as being the original software.
3. This notice may not be removed or altered from any source distribution.

AFL-2.1

The Academic Free License
v.2.1

This Academic Free License (the "License") applies to any original work of authorship (the "Original Work") whose owner (the "Licensor") has placed the following notice immediately following the copyright notice for the Original Work:

Licensed under the Academic Free License version 2.1

1) Grant of Copyright License. Licensor hereby grants You a world-wide, royalty-free, non-exclusive, perpetual, sublicenseable license to do the following:

- a) to reproduce the Original Work in copies;
- b) to prepare derivative works ("Derivative Works") based upon the Original Work;
- c) to distribute copies of the Original Work and Derivative Works to the public;
- d) to perform the Original Work publicly; and
- e) to display the Original Work publicly.

2) Grant of Patent License. Licensor hereby grants You a world-wide, royalty-free, non-exclusive, perpetual, sublicenseable license, under patent claims owned or controlled by the Licensor that are embodied in the Original Work as furnished by the Licensor, to make, use, sell and offer for sale the Original Work and Derivative Works.

3) Grant of Source Code License. The term "Source Code" means the preferred form of the Original Work for making modifications to it and all available documentation describing how to modify the Original Work. Licensor hereby agrees to provide a machine-readable copy of the Source Code of the Original Work along with each copy of the Original Work that Licensor distributes. Licensor reserves the right to satisfy this obligation by placing a machine-

readable copy of the Source Code in an information repository reasonably calculated to permit inexpensive and convenient access by You for as long as Licensor continues to distribute the Original Work, and by publishing the address of that information repository in a notice immediately following the copyright notice that applies to the Original Work.

4) Exclusions From License Grant. Neither the names of Licensor, nor the names of any contributors to the Original Work, nor any of their trademarks or service marks, may be used to endorse or promote products derived from this Original Work without express prior written permission of the Licensor. Nothing in this License shall be deemed to grant any rights to trademarks, copyrights, patents, trade secrets or any other intellectual property of Licensor except as expressly stated herein. No patent license is granted to make, use, sell or offer to sell embodiments of any patent claims other than the licensed claims defined in Section 2. No right is granted to the trademarks of Licensor even if such marks are included in the Original Work. Nothing in this License shall be interpreted to prohibit Licensor from licensing under different terms from this License any Original Work that Licensor otherwise would have a right to license.

5) This section intentionally omitted.

6) Attribution Rights. You must retain, in the Source Code of any Derivative Works that You create, all copyright, patent or trademark notices from the Source Code of the Original Work, as well as any notices of licensing and any descriptive text identified therein as an "Attribution Notice." You must cause the Source Code for any Derivative Works that You create to carry a prominent Attribution Notice reasonably calculated to inform recipients that You have modified the Original Work.

7) Warranty of Provenance and Disclaimer of Warranty. Licensor warrants that the copyright in and to the Original Work and the patent rights granted herein by Licensor are owned by the Licensor or are sublicensed to You under the terms of this License with the permission of the contributor(s) of those copyrights and patent rights. Except as expressly stated in the immediately preceding sentence, the Original Work is provided under this License on an "AS IS" BASIS and WITHOUT WARRANTY, either express or implied, including, without limitation, the warranties of NON-INFRINGEMENT, MERCHANTABILITY or FITNESS FOR A PARTICULAR PURPOSE. THE ENTIRE RISK AS TO THE QUALITY OF THE ORIGINAL WORK IS WITH YOU. This DISCLAIMER OF WARRANTY constitutes an essential part of this License. No license to Original Work is granted hereunder except under this disclaimer.

8) Limitation of Liability. Under no circumstances and under no legal theory, whether in tort (including negligence), contract, or otherwise, shall the Licensor be liable to any person for any direct, indirect, special, incidental, or consequential damages of any character arising as a result of this License or the use of the Original Work including, without limitation, damages for loss of goodwill, work stoppage, computer failure or malfunction, or any and all other commercial damages or losses. This limitation of liability shall not apply to liability for death or personal injury resulting from Licensor's negligence to the extent applicable law prohibits such limitation. Some jurisdictions do not allow the exclusion or limitation of incidental or

consequential damages, so this exclusion and limitation may not apply to You.

9) Acceptance and Termination. If You distribute copies of the Original Work or a Derivative Work, You must make a reasonable effort under the circumstances to obtain the express assent of recipients to the terms of this License. Nothing else but this License (or another written agreement between Licensor and You) grants You permission to create Derivative Works based upon the Original Work or to exercise any of the rights granted in Section 1 herein, and any attempt to do so except under the terms of this License (or another written agreement between Licensor and You) is expressly prohibited by U.S. copyright law, the equivalent laws of other countries, and by international treaty. Therefore, by exercising any of the rights granted to You in Section 1 herein, You indicate Your acceptance of this License and all of its terms and conditions.

10) Termination for Patent Action. This License shall terminate automatically and You may no longer exercise any of the rights granted to You by this License as of the date You commence an action, including a cross-claim or counterclaim, against Licensor or any licensee alleging that the Original Work infringes a patent. This termination provision shall not apply for an action alleging patent infringement by combinations of the Original Work with other software or hardware.

11) Jurisdiction, Venue and Governing Law. Any action or suit relating to this License may be brought only in the courts of a jurisdiction wherein the Licensor resides or in which Licensor conducts its primary business, and under the laws of that jurisdiction excluding its conflict-of-law provisions. The application of the United Nations Convention on Contracts for the International Sale of Goods is expressly excluded. Any use of the Original Work outside the scope of this License or after its termination shall be subject to the requirements and penalties of the U.S. Copyright Act, 17 U.S.C. § 101 et seq., the equivalent laws of other countries, and international treaty. This section shall survive the termination of this License.

12) Attorneys Fees. In any action to enforce the terms of this License or seeking damages relating thereto, the prevailing party shall be entitled to recover its costs and expenses, including, without limitation, reasonable attorneys' fees and costs incurred in connection with such action, including any appeal of such action. This section shall survive the termination of this License.

13) Miscellaneous. This License represents the complete agreement concerning the subject matter hereof. If any provision of this License is held to be unenforceable, such provision shall be reformed only to the extent necessary to make it enforceable.

14) Definition of "You" in This License. "You" throughout this License, whether in upper or lower case, means an individual or a legal entity exercising rights under, and complying with all of the terms of, this License. For legal entities, "You" includes any entity that controls, is controlled by, or is under common control with you. For purposes of this definition, "control" means (i) the power, direct or indirect, to cause the direction or management of such entity,



whether by contract or otherwise, or (ii) ownership of fifty percent (50%) or more of the outstanding shares, or (iii) beneficial ownership of such entity.

15) Right to Use. You may use the Original Work in all ways not otherwise restricted or conditioned by this License or by law, and Licensor promises not to interfere with or be responsible for such uses by You.

This license is Copyright (C) 2003-2004 Lawrence E. Rosen. All rights reserved.

Permission is hereby granted to copy and distribute this license without modification. This license may not be modified without the express written permission of its copyright owner.

Anti-Grain Geometry Public License

Permission to copy, use, modify, sell and distribute this software is granted provided this copyright notice appears in all copies.

This software is provided "as is" without express or implied warranty, and with no claim as to its suitability for any purpose.

Apache-2.0

Apache License

Version 2.0, January 2004

<http://www.apache.org/licenses/>

TERMS AND CONDITIONS FOR USE, REPRODUCTION, AND DISTRIBUTION

1. Definitions.

"License" shall mean the terms and conditions for use, reproduction, and distribution as defined by Sections 1 through 9 of this document.

"Licensor" shall mean the copyright owner or entity authorized by the copyright owner that is granting the License.

"Legal Entity" shall mean the union of the acting entity and all other entities that control, are controlled by, or are under common control with that entity. For the purposes of this definition, "control" means (i) the power, direct or indirect, to cause the direction or management of such entity, whether by contract or otherwise, or (ii) ownership of fifty percent (50%) or more of the outstanding shares, or (iii) beneficial ownership of such entity.



"You" (or "Your") shall mean an individual or Legal Entity exercising permissions granted by this License.

"Source" form shall mean the preferred form for making modifications, including but not limited to software source code, documentation source, and configuration files.

"Object" form shall mean any form resulting from mechanical transformation or translation of a Source form, including but not limited to compiled object code, generated documentation, and conversions to other media types.

"Work" shall mean the work of authorship, whether in Source or Object form, made available under the License, as indicated by a copyright notice that is included in or attached to the work (an example is provided in the Appendix below).

"Derivative Works" shall mean any work, whether in Source or Object form, that is based on (or derived from) the Work and for which the editorial revisions, annotations, elaborations, or other modifications represent, as a whole, an original work of authorship. For the purposes of this License, Derivative Works shall not include works that remain separable from, or merely link (or bind by name) to the interfaces of, the Work and Derivative Works thereof.

"Contribution" shall mean any work of authorship, including the original version of the Work and any modifications or additions to that Work or Derivative Works thereof, that is intentionally submitted to Licensor for inclusion in the Work by the copyright owner or by an individual or Legal Entity authorized to submit on behalf of the copyright owner. For the purposes of this definition, "submitted" means any form of electronic, verbal, or written communication sent to the Licensor or its representatives, including but not limited to communication on electronic mailing lists, source code control systems, and issue tracking systems that are managed by, or on behalf of, the Licensor for the purpose of discussing and improving the Work, but excluding communication that is conspicuously marked or otherwise designated in writing by the copyright owner as "Not a Contribution."

"Contributor" shall mean Licensor and any individual or Legal Entity on behalf of whom a Contribution has been received by Licensor and subsequently incorporated within the Work.

2. Grant of Copyright License. Subject to the terms and conditions of this License, each Contributor hereby grants to You a perpetual, worldwide, non-exclusive, no-charge, royalty-free, irrevocable copyright license to reproduce, prepare Derivative Works of, publicly display, publicly perform, sublicense, and distribute the Work and such Derivative Works in Source or Object form.

3. Grant of Patent License. Subject to the terms and conditions of this License, each Contributor hereby grants to You a perpetual, worldwide, non-exclusive, no-charge, royalty-free, irrevocable (except as stated in this section) patent license to make, have made, use,

offer to sell, sell, import, and otherwise transfer the Work, where such license applies only to those patent claims licensable by such Contributor that are necessarily infringed by their Contribution(s) alone or by combination of their Contribution(s) with the Work to which such Contribution(s) was submitted. If You institute patent litigation against any entity (including a cross-claim or counterclaim in a lawsuit) alleging that the Work or a Contribution incorporated within the Work constitutes direct or contributory patent infringement, then any patent licenses granted to You under this License for that Work shall terminate as of the date such litigation is filed.

4. Redistribution. You may reproduce and distribute copies of the Work or Derivative Works thereof in any medium, with or without modifications, and in Source or Object form, provided that You meet the following conditions:

(a) You must give any other recipients of the Work or Derivative Works a copy of this License; and

(b) You must cause any modified files to carry prominent notices stating that You changed the files; and

(c) You must retain, in the Source form of any Derivative Works that You distribute, all copyright, patent, trademark, and attribution notices from the Source form of the Work, excluding those notices that do not pertain to any part of the Derivative Works; and

(d) If the Work includes a "NOTICE" text file as part of its distribution, then any Derivative Works that You distribute must include a readable copy of the attribution notices contained within such NOTICE file, excluding those notices that do not pertain to any part of the Derivative Works, in at least one of the following places: within a NOTICE text file distributed as part of the Derivative Works; within the Source form or documentation, if provided along with the Derivative Works; or, within a display generated by the Derivative Works, if and wherever such third-party notices normally appear. The contents of the NOTICE file are for informational purposes only and do not modify the License. You may add Your own attribution notices within Derivative Works that You distribute, alongside or as an addendum to the NOTICE text from the Work, provided that such additional attribution notices cannot be construed as modifying the License.

You may add Your own copyright statement to Your modifications and may provide additional or different license terms and conditions for use, reproduction, or distribution of Your modifications, or for any such Derivative Works as a whole, provided Your use, reproduction, and distribution of the Work otherwise complies with the conditions stated in this License.

5. Submission of Contributions. Unless You explicitly state otherwise, any Contribution intentionally submitted for inclusion in the Work by You to the Licensor shall be under the terms and conditions of this License, without any additional terms or conditions.



Notwithstanding the above, nothing herein shall supersede or modify the terms of any separate license agreement you may have executed with Licensor regarding such Contributions.

6. Trademarks. This License does not grant permission to use the trade names, trademarks, service marks, or product names of the Licensor, except as required for reasonable and customary use in describing the origin of the Work and reproducing the content of the NOTICE file.

7. Disclaimer of Warranty. Unless required by applicable law or agreed to in writing, Licensor provides the Work (and each Contributor provides its Contributions) on an "AS IS" BASIS, WITHOUT WARRANTIES OR CONDITIONS OF ANY KIND, either express or implied, including, without limitation, any warranties or conditions of TITLE, NON-INFRINGEMENT, MERCHANTABILITY, or FITNESS FOR A PARTICULAR PURPOSE. You are solely responsible for determining the appropriateness of using or redistributing the Work and assume any risks associated with Your exercise of permissions under this License.

8. Limitation of Liability. In no event and under no legal theory, whether in tort (including negligence), contract, or otherwise, unless required by applicable law (such as deliberate and grossly negligent acts) or agreed to in writing, shall any Contributor be liable to You for damages, including any direct, indirect, special, incidental, or consequential damages of any character arising as a result of this License or out of the use or inability to use the Work (including but not limited to damages for loss of goodwill, work stoppage, computer failure or malfunction, or any and all other commercial damages or losses), even if such Contributor has been advised of the possibility of such damages.

9. Accepting Warranty or Additional Liability. While redistributing the Work or Derivative Works thereof, You may choose to offer, and charge a fee for, acceptance of support, warranty, indemnity, or other liability obligations and/or rights consistent with this License. However, in accepting such obligations, You may act only on Your own behalf and on Your sole responsibility, not on behalf of any other Contributor, and only if You agree to indemnify, defend, and hold each Contributor harmless for any liability incurred by, or claims asserted against, such Contributor by reason of your accepting any such warranty or additional liability.

END OF TERMS AND CONDITIONS

APPENDIX: How to apply the Apache License to your work.

To apply the Apache License to your work, attach the following boilerplate notice, with the fields enclosed by brackets "[]" replaced with your own identifying information. (Don't include the brackets!) The text should be enclosed in the appropriate comment syntax for the file format. We also recommend that a file or class name and description of purpose be included on the same "printed page" as the copyright notice for easier identification within third-party

archives.

Copyright [yyyy] [name of copyright owner]

Licensed under the Apache License, Version 2.0 (the "License");
you may not use this file except in compliance with the License.
You may obtain a copy of the License at

<http://www.apache.org/licenses/LICENSE-2.0>

Unless required by applicable law or agreed to in writing, software distributed under the License is distributed on an "AS IS" BASIS, WITHOUT WARRANTIES OR CONDITIONS OF ANY KIND, either express or implied.

See the License for the specific language governing permissions and limitations under the License.

Artistic-1.0-Perl

The "Artistic License"

Preamble

The intent of this document is to state the conditions under which a Package may be copied, such that the Copyright Holder maintains some semblance of artistic control over the development of the package, while giving the users of the package the right to use and distribute the Package in a more-or-less customary fashion, plus the right to make reasonable modifications.

Definitions:

"Package" refers to the collection of files distributed by the Copyright Holder, and derivatives of that collection of files created through textual modification.

"Standard Version" refers to such a Package if it has not been modified, or has been modified in accordance with the wishes of the Copyright Holder as specified below.

"Copyright Holder" is whoever is named in the copyright or copyrights for the package.

"You" is you, if you're thinking about copying or distributing this Package.

"Reasonable copying fee" is whatever you can justify on the basis of media cost, duplication charges, time of people involved, and so on. (You will not be required to justify it to the Copyright Holder, but only to the computing community at large as a market that must bear the fee.)

"Freely Available" means that no fee is charged for the item itself, though there may be fees involved in handling the item. It also means that recipients of the item may redistribute it under the same conditions they received it.

1. You may make and give away verbatim copies of the source form of the Standard Version of this Package without restriction, provided that you duplicate all of the original copyright notices and associated disclaimers.

2. You may apply bug fixes, portability fixes and other modifications derived from the Public Domain or from the Copyright Holder. A Package modified in such a way shall still be considered the Standard Version.

3. You may otherwise modify your copy of this Package in any way, provided that you insert a prominent notice in each changed file stating how and when you changed that file, and provided that you do at least ONE of the following:

- a) place your modifications in the Public Domain or otherwise make them Freely Available, such as by posting said modifications to Usenet or an equivalent medium, or placing the modifications on a major archive site such as uunet.uu.net, or by allowing the Copyright Holder to include your modifications in the Standard Version of the Package.
- b) use the modified Package only within your corporation or organization.
- c) rename any non-standard executables so the names do not conflict with standard executables, which must also be provided, and provide a separate manual page for each non-standard executable that clearly documents how it differs from the Standard Version.
- d) make other distribution arrangements with the Copyright Holder.

4. You may distribute the programs of this Package in object code or executable form, provided that you do at least ONE of the following:

- a) distribute a Standard Version of the executables and library files, together with instructions (in the manual page or equivalent) on where to get the Standard Version.
- b) accompany the distribution with the machine-readable source of the Package with your modifications.
- c) give non-standard executables non-standard names, and clearly document the differences in manual pages (or equivalent), together with instructions on where to get the Standard Version.

d) make other distribution arrangements with the Copyright Holder.

5. You may charge a reasonable copying fee for any distribution of this Package. You may charge any fee you choose for support of this Package. You may not charge a fee for this Package itself. However, you may distribute this Package in aggregate with other (possibly commercial) programs as part of a larger (possibly commercial) software distribution provided that you do not advertise this Package as a product of your own. You may embed this Package's interpreter within an executable of yours (by linking); this shall be construed as a mere form of aggregation, provided that the complete Standard Version of the interpreter is so embedded.

6. The scripts and library files supplied as input to or produced as output from the programs of this Package do not automatically fall under the copyright of this Package, but belong to whoever generated them, and may be sold commercially, and may be aggregated with this Package. If such scripts or library files are aggregated with this Package via the so-called "undump" or "unexec" methods of producing a binary executable image, then distribution of such an image shall neither be construed as a distribution of this Package nor shall it fall under the restrictions of Paragraphs 3 and 4, provided that you do not represent such an executable image as a Standard Version of this Package.

7. C subroutines (or comparably compiled subroutines in other languages) supplied by you and linked into this Package in order to emulate subroutines and variables of the language defined by this Package shall not be considered part of this Package, but are the equivalent of input as in Paragraph 6, provided these subroutines do not change the language in any way that would cause it to fail the regression tests for the language.

8. Aggregation of this Package with a commercial distribution is always permitted provided that the use of this Package is embedded; that is, when no overt attempt is made to make this Package's interfaces visible to the end user of the commercial distribution. Such use shall not be construed as a distribution of this Package.

9. The name of the Copyright Holder may not be used to endorse or promote products derived from this software without specific prior written permission.

10. THIS PACKAGE IS PROVIDED "AS IS" AND WITHOUT ANY EXPRESS OR IMPLIED WARRANTIES, INCLUDING, WITHOUT LIMITATION, THE IMPLIED WARRANTIES OF MERCHANTABILITY AND FITNESS FOR A PARTICULAR PURPOSE.

The End

Artistic-2.0

The Artistic License 2.0

Copyright (c) 2000-2006, The Perl Foundation.

Everyone is permitted to copy and distribute verbatim copies of this license document, but changing it is not allowed.

Preamble

This license establishes the terms under which a given free software Package may be copied, modified, distributed, and/or redistributed. The intent is that the Copyright Holder maintains some artistic control over the development of that Package while still keeping the Package available as open source and free software.

You are always permitted to make arrangements wholly outside of this license directly with the Copyright Holder of a given Package. If the terms of this license do not permit the full use that you propose to make of the Package, you should contact the Copyright Holder and seek a different licensing arrangement.

Definitions

"Copyright Holder" means the individual(s) or organization(s) named in the copyright notice for the entire Package.

"Contributor" means any party that has contributed code or other material to the Package, in accordance with the Copyright Holder's procedures.

"You" and "your" means any person who would like to copy, distribute, or modify the Package.

"Package" means the collection of files distributed by the Copyright Holder, and derivatives of that collection and/or of those files. A given Package may consist of either the Standard Version, or a Modified Version.

"Distribute" means providing a copy of the Package or making it accessible to anyone else, or in the case of a company or organization, to others outside of your company or organization.

"Distributor Fee" means any fee that you charge for Distributing this Package or providing support for this Package to another party. It does not mean licensing fees.

"Standard Version" refers to the Package if it has not been modified, or has been modified only in ways explicitly requested by the Copyright Holder.

"Modified Version" means the Package, if it has been changed, and such changes were not explicitly requested by the Copyright Holder.

"Original License" means this Artistic License as Distributed with the Standard Version of the Package, in its current version or as it may be modified by The Perl Foundation in the future.

"Source" form means the source code, documentation source, and configuration files for the Package.

"Compiled" form means the compiled bytecode, object code, binary, or any other form resulting from mechanical transformation or translation of the Source form.

Permission for Use and Modification Without Distribution

(1) You are permitted to use the Standard Version and create and use Modified Versions for any purpose without restriction, provided that you do not Distribute the Modified Version.

Permissions for Redistribution of the Standard Version

(2) You may Distribute verbatim copies of the Source form of the Standard Version of this Package in any medium without restriction, either gratis or for a Distributor Fee, provided that you duplicate all of the original copyright notices and associated disclaimers. At your discretion, such verbatim copies may or may not include a Compiled form of the Package.

(3) You may apply any bug fixes, portability changes, and other modifications made available from the Copyright Holder. The resulting Package will still be considered the Standard Version, and as such will be subject to the Original License.

Distribution of Modified Versions of the Package as Source

(4) You may Distribute your Modified Version as Source (either gratis or for a Distributor Fee, and with or without a Compiled form of the Modified Version) provided that you clearly document how it differs from the Standard Version, including, but not limited to, documenting any non-standard features, executables, or modules, and provided that you do at least ONE of the following:

(a) make the Modified Version available to the Copyright Holder of the Standard Version,

under the Original License, so that the Copyright Holder may include your modifications in the Standard Version.

(b) ensure that installation of your Modified Version does not prevent the user installing or running the Standard Version. In addition, the Modified Version must bear a name that is different from the name of the Standard Version.

(c) allow anyone who receives a copy of the Modified Version to make the Source form of the Modified Version available to others under

(i) the Original License or

(ii) a license that permits the licensee to freely copy, modify and redistribute the Modified Version using the same licensing terms that apply to the copy that the licensee received, and requires that the Source form of the Modified Version, and of any works derived from it, be made freely available in that license fees are prohibited but Distributor Fees are allowed.

Distribution of Compiled Forms of the Standard Version or Modified Versions without the Source

(5) You may Distribute Compiled forms of the Standard Version without the Source, provided that you include complete instructions on how to get the Source of the Standard Version. Such instructions must be valid at the time of your distribution. If these instructions, at any time while you are carrying out such distribution, become invalid, you must provide new instructions on demand or cease further distribution. If you provide valid instructions or cease distribution within thirty days after you become aware that the instructions are invalid, then you do not forfeit any of your rights under this license.

(6) You may Distribute a Modified Version in Compiled form without the Source, provided that you comply with Section 4 with respect to the Source of the Modified Version.

Aggregating or Linking the Package

(7) You may aggregate the Package (either the Standard Version or Modified Version) with other packages and Distribute the resulting aggregation provided that you do not charge a licensing fee for the Package. Distributor Fees are permitted, and licensing fees for other components in the aggregation are permitted. The terms of this license apply to the use and Distribution of the Standard or Modified Versions as included in the aggregation.

(8) You are permitted to link Modified and Standard Versions with other works, to embed the Package in a larger work of your own, or to build stand-alone binary or bytecode versions of applications that include the Package, and Distribute the result without restriction, provided the result does not expose a direct interface to the Package.

Items That are Not Considered Part of a Modified Version

(9) Works (including, but not limited to, modules and scripts) that merely extend or make use of the Package, do not, by themselves, cause the Package to be a Modified Version. In addition, such works are not considered parts of the Package itself, and are not subject to the terms of this license.

General Provisions

(10) Any use, modification, and distribution of the Standard or Modified Versions is governed by this Artistic License. By using, modifying or distributing the Package, you accept this license. Do not use, modify, or distribute the Package, if you do not accept this license.

(11) If your Modified Version has been derived from a Modified Version made by someone other than you, you are nevertheless required to ensure that your Modified Version complies with the requirements of this license.

(12) This license does not grant you the right to use any trademark, service mark, tradename, or logo of the Copyright Holder.

(13) This license includes the non-exclusive, worldwide, free-of-charge patent license to make, have made, use, offer to sell, sell, import and otherwise transfer the Package with respect to any patent claims licensable by the Copyright Holder that are necessarily infringed by the Package. If you institute patent litigation (including a cross-claim or counterclaim) against any party alleging that the Package constitutes direct or contributory patent infringement, then this Artistic License to you shall terminate on the date that such litigation is filed.

(14) Disclaimer of Warranty:

THE PACKAGE IS PROVIDED BY THE COPYRIGHT HOLDER AND CONTRIBUTORS "AS IS" AND WITHOUT ANY EXPRESS OR IMPLIED WARRANTIES. THE IMPLIED WARRANTIES OF MERCHANTABILITY, FITNESS FOR A PARTICULAR PURPOSE, OR NON-INFRINGEMENT ARE DISCLAIMED TO THE EXTENT PERMITTED BY YOUR LOCAL LAW. UNLESS REQUIRED BY LAW, NO COPYRIGHT HOLDER OR CONTRIBUTOR WILL BE LIABLE FOR ANY DIRECT, INDIRECT, INCIDENTAL, OR CONSEQUENTIAL DAMAGES ARISING IN ANY WAY OUT OF THE USE OF THE PACKAGE, EVEN IF ADVISED OF THE POSSIBILITY OF SUCH DAMAGE.

BSD-2-Clause

Copyright (c) <year> <owner> All rights reserved.

Redistribution and use in source and binary forms, with or without modification, are permitted provided that the following conditions are met:

1. Redistributions of source code must retain the above copyright notice, this list of conditions and the following disclaimer.
2. Redistributions in binary form must reproduce the above copyright notice, this list of conditions and the following disclaimer in the documentation and/or other materials provided with the distribution.

THIS SOFTWARE IS PROVIDED BY THE COPYRIGHT HOLDERS AND CONTRIBUTORS "AS IS" AND ANY EXPRESS OR IMPLIED WARRANTIES, INCLUDING, BUT NOT LIMITED TO, THE IMPLIED WARRANTIES OF MERCHANTABILITY AND FITNESS FOR A PARTICULAR PURPOSE ARE DISCLAIMED. IN NO EVENT SHALL THE COPYRIGHT HOLDER OR CONTRIBUTORS BE LIABLE FOR ANY DIRECT, INDIRECT, INCIDENTAL, SPECIAL, EXEMPLARY, OR CONSEQUENTIAL DAMAGES (INCLUDING, BUT NOT LIMITED TO, PROCUREMENT OF SUBSTITUTE GOODS OR SERVICES; LOSS OF USE, DATA, OR PROFITS; OR BUSINESS INTERRUPTION) HOWEVER CAUSED AND ON ANY THEORY OF LIABILITY, WHETHER IN CONTRACT, STRICT LIABILITY, OR TORT (INCLUDING NEGLIGENCE OR OTHERWISE) ARISING IN ANY WAY OUT OF THE USE OF THIS SOFTWARE, EVEN IF ADVISED OF THE POSSIBILITY OF SUCH DAMAGE.

BSD-3-Clause

Copyright (c) <year> <owner>. All rights reserved.

Redistribution and use in source and binary forms, with or without modification, are permitted provided that the following conditions are met:

1. Redistributions of source code must retain the above copyright notice, this list of conditions and the following disclaimer.
2. Redistributions in binary form must reproduce the above copyright notice, this list of conditions and the following disclaimer in the documentation and/or other materials provided with the distribution.
3. Neither the name of the copyright holder nor the names of its contributors may be used to endorse or promote products derived from this software without specific prior written



permission.

THIS SOFTWARE IS PROVIDED BY THE COPYRIGHT HOLDERS AND CONTRIBUTORS "AS IS" AND ANY EXPRESS OR IMPLIED WARRANTIES, INCLUDING, BUT NOT LIMITED TO, THE IMPLIED WARRANTIES OF MERCHANTABILITY AND FITNESS FOR A PARTICULAR PURPOSE ARE DISCLAIMED. IN NO EVENT SHALL THE COPYRIGHT HOLDER OR CONTRIBUTORS BE LIABLE FOR ANY DIRECT, INDIRECT, INCIDENTAL, SPECIAL, EXEMPLARY, OR CONSEQUENTIAL DAMAGES (INCLUDING, BUT NOT LIMITED TO, PROCUREMENT OF SUBSTITUTE GOODS OR SERVICES; LOSS OF USE, DATA, OR PROFITS; OR BUSINESS INTERRUPTION) HOWEVER CAUSED AND ON ANY THEORY OF LIABILITY, WHETHER IN CONTRACT, STRICT LIABILITY, OR TORT (INCLUDING NEGLIGENCE OR OTHERWISE) ARISING IN ANY WAY OUT OF THE USE OF THIS SOFTWARE, EVEN IF ADVISED OF THE POSSIBILITY OF SUCH DAMAGE.

BSD-4-Clause

Copyright (c) <year> <owner>. All rights reserved.

Redistribution and use in source and binary forms, with or without modification, are permitted provided that the following conditions are met:

1. Redistributions of source code must retain the above copyright notice, this list of conditions and the following disclaimer.
2. Redistributions in binary form must reproduce the above copyright notice, this list of conditions and the following disclaimer in the documentation and/or other materials provided with the distribution.
3. All advertising materials mentioning features or use of this software must display the following acknowledgement:
This product includes software developed by the organization.
4. Neither the name of the copyright holder nor the names of its contributors may be used to endorse or promote products derived from this software without specific prior written permission.

THIS SOFTWARE IS PROVIDED BY COPYRIGHT HOLDER "AS IS" AND ANY EXPRESS OR IMPLIED WARRANTIES, INCLUDING, BUT NOT LIMITED TO, THE IMPLIED WARRANTIES OF MERCHANTABILITY AND FITNESS FOR A PARTICULAR PURPOSE ARE DISCLAIMED. IN NO EVENT SHALL COPYRIGHT HOLDER BE LIABLE FOR ANY DIRECT, INDIRECT, INCIDENTAL, SPECIAL, EXEMPLARY, OR CONSEQUENTIAL DAMAGES (INCLUDING, BUT NOT LIMITED TO, PROCUREMENT OF SUBSTITUTE GOODS OR SERVICES; LOSS OF USE, DATA, OR PROFITS; OR BUSINESS INTERRUPTION) HOWEVER CAUSED AND ON ANY THEORY OF LIABILITY, WHETHER IN CONTRACT, STRICT LIABILITY, OR TORT (INCLUDING NEGLIGENCE OR OTHERWISE) ARISING IN ANY WAY OUT OF THE USE OF THIS SOFTWARE, EVEN IF ADVISED OF THE POSSIBILITY OF SUCH DAMAGE.

BSD-like License (android-external-dhcpd)

Copyright (c) 2006-2015 Roy Marples <roy@marples.name> All rights reserved

Redistribution and use in source and binary forms, with or without modification, are permitted provided that the following conditions are met:

1. Redistributions of source code must retain the above copyright notice, this list of conditions and the following disclaimer.
2. Redistributions in binary form must reproduce the above copyright notice, this list of conditions and the following disclaimer in the documentation and/or other materials provided with the distribution.

THIS SOFTWARE IS PROVIDED BY THE AUTHOR AND CONTRIBUTORS ``AS IS'' AND ANY EXPRESS OR IMPLIED WARRANTIES, INCLUDING, BUT NOT LIMITED TO, THE IMPLIED WARRANTIES OF MERCHANTABILITY AND FITNESS FOR A PARTICULAR PURPOSE ARE DISCLAIMED. IN NO EVENT SHALL THE AUTHOR OR CONTRIBUTORS BE LIABLE FOR ANY DIRECT, INDIRECT, INCIDENTAL, SPECIAL, EXEMPLARY, OR CONSEQUENTIAL DAMAGES (INCLUDING, BUT NOT LIMITED TO, PROCUREMENT OF SUBSTITUTE GOODS OR SERVICES; LOSS OF USE, DATA, OR PROFITS; OR BUSINESS INTERRUPTION) HOWEVER CAUSED AND ON ANY THEORY OF LIABILITY, WHETHER IN CONTRACT, STRICT LIABILITY, OR TORT (INCLUDING NEGLIGENCE OR OTHERWISE) ARISING IN ANY WAY OUT OF THE USE OF THIS SOFTWARE, EVEN IF ADVISED OF THE POSSIBILITY OF SUCH DAMAGE.

dhcp_bpf_filter taken from bpf.c in dhcp-3.1.0

Copyright (c) 2004,2007 by Internet Systems Consortium, Inc. ("ISC")

Copyright (c) 1996-2003 by Internet Software Consortium

Permission to use, copy, modify, and distribute this software for any purpose with or without fee is hereby granted, provided that the above copyright notice and this permission notice appear in all copies.

THE SOFTWARE IS PROVIDED "AS IS" AND ISC DISCLAIMS ALL WARRANTIES WITH REGARD TO THIS SOFTWARE INCLUDING ALL IMPLIED WARRANTIES OF MERCHANTABILITY AND FITNESS. IN NO EVENT SHALL ISC BE LIABLE FOR ANY SPECIAL, DIRECT, INDIRECT, OR CONSEQUENTIAL DAMAGES OR ANY DAMAGES WHATSOEVER RESULTING FROM LOSS OF USE, DATA OR PROFITS, WHETHER IN AN ACTION OF CONTRACT, NEGLIGENCE OR OTHER TORTIOUS ACTION, ARISING OUT



OF OR IN CONNECTION WITH THE USE OR PERFORMANCE OF THIS SOFTWARE.

Internet Systems Consortium, Inc.

950 Charter Street

Redwood City, CA 94063

<info@isc.org>

<http://www.isc.org/>

\$NetBSD: queue.h,v 1.65 2013/12/25 17:19:34 christos Exp \$

Copyright (c) 1991, 1993

The Regents of the University of California. All rights reserved.

Redistribution and use in source and binary forms, with or without modification, are permitted provided that the following conditions are met:

1. Redistributions of source code must retain the above copyright notice, this list of conditions and the following disclaimer.
2. Redistributions in binary form must reproduce the above copyright notice, this list of conditions and the following disclaimer in the documentation and/or other materials provided with the distribution.
3. Neither the name of the University nor the names of its contributors may be used to endorse or promote products derived from this software without specific prior written permission.

THIS SOFTWARE IS PROVIDED BY THE REGENTS AND CONTRIBUTORS ``AS IS'' AND ANY EXPRESS OR IMPLIED WARRANTIES, INCLUDING, BUT NOT LIMITED TO, THE IMPLIED WARRANTIES OF MERCHANTABILITY AND FITNESS FOR A PARTICULAR PURPOSE ARE DISCLAIMED. IN NO EVENT SHALL THE REGENTS OR CONTRIBUTORS BE LIABLE FOR ANY DIRECT, INDIRECT, INCIDENTAL, SPECIAL, EXEMPLARY, OR CONSEQUENTIAL DAMAGES (INCLUDING, BUT NOT LIMITED TO, PROCUREMENT OF SUBSTITUTE GOODS OR SERVICES; LOSS OF USE, DATA, OR PROFITS; OR BUSINESS INTERRUPTION) HOWEVER CAUSED AND ON ANY THEORY OF LIABILITY, WHETHER IN CONTRACT, STRICT LIABILITY, OR TORT (INCLUDING NEGLIGENCE OR OTHERWISE) ARISING IN ANY WAY OUT OF THE USE OF THIS SOFTWARE, EVEN IF ADVISED OF THE POSSIBILITY OF SUCH DAMAGE.

@(#)queue.h 8.5 (Berkeley) 8/20/94

compat/arc4random_uniform.c, compat/arc4random_uniform.h



Copyright (c) 2008, Damien Miller <djm@openbsd.org>

Permission to use, copy, modify, and distribute this software for any purpose with or without fee is hereby granted, provided that the above copyright notice and this permission notice appear in all copies.

THE SOFTWARE IS PROVIDED "AS IS" AND THE AUTHOR DISCLAIMS ALL WARRANTIES WITH REGARD TO THIS SOFTWARE INCLUDING ALL IMPLIED WARRANTIES OF MERCHANTABILITY AND FITNESS. IN NO EVENT SHALL THE AUTHOR BE LIABLE FOR ANY SPECIAL, DIRECT, INDIRECT, OR CONSEQUENTIAL DAMAGES OR ANY DAMAGES WHATSOEVER RESULTING FROM LOSS OF USE, DATA OR PROFITS, WHETHER IN AN ACTION OF CONTRACT, NEGLIGENCE OR OTHER TORTIOUS ACTION, ARISING OUT OF OR IN CONNECTION WITH THE USE OR PERFORMANCE OF THIS SOFTWARE.

Arc4 random number generator for OpenBSD.
Copyright 1996 David Mazieres <dm@lcs.mit.edu>.

Modification and redistribution in source and binary forms is permitted provided that due credit is given to the author and the OpenBSD project by leaving this copyright notice intact.

crypt/sha256.c, crypt/sha256.h
Copyright 2005 Colin Percival
All rights reserved.

Redistribution and use in source and binary forms, with or without modification, are permitted provided that the following conditions are met:

1. Redistributions of source code must retain the above copyright notice, this list of conditions and the following disclaimer.
2. Redistributions in binary form must reproduce the above copyright notice, this list of conditions and the following disclaimer in the documentation and/or other materials provided with the distribution.

THIS SOFTWARE IS PROVIDED BY THE AUTHOR AND CONTRIBUTORS ``AS IS'' AND ANY EXPRESS OR IMPLIED WARRANTIES, INCLUDING, BUT NOT LIMITED TO, THE IMPLIED WARRANTIES OF MERCHANTABILITY AND FITNESS FOR A PARTICULAR PURPOSE ARE DISCLAIMED. IN NO EVENT SHALL THE AUTHOR OR CONTRIBUTORS BE LIABLE FOR ANY DIRECT, INDIRECT, INCIDENTAL, SPECIAL, EXEMPLARY, OR CONSEQUENTIAL DAMAGES (INCLUDING, BUT NOT LIMITED TO, PROCUREMENT OF SUBSTITUTE GOODS

OR SERVICES; LOSS OF USE, DATA, OR PROFITS; OR BUSINESS INTERRUPTION) HOWEVER CAUSED AND ON ANY THEORY OF LIABILITY, WHETHER IN CONTRACT, STRICT LIABILITY, OR TORT (INCLUDING NEGLIGENCE OR OTHERWISE) ARISING IN ANY WAY OUT OF THE USE OF THIS SOFTWARE, EVEN IF ADVISED OF THE POSSIBILITY OF SUCH DAMAGE.

BSD-like License (file)

Redistribution and use in source and binary forms, with or without modification, are permitted provided that the following conditions are met:

1. Redistributions of source code must retain the above copyright notice immediately at the beginning of the file, without modification, this list of conditions, and the following disclaimer.
2. Redistributions in binary form must reproduce the above copyright notice, this list of conditions and the following disclaimer in the documentation and/or other materials provided with the distribution.

THIS SOFTWARE IS PROVIDED BY THE AUTHOR AND CONTRIBUTORS ``AS IS'' AND ANY EXPRESS OR IMPLIED WARRANTIES, INCLUDING, BUT NOT LIMITED TO, THE IMPLIED WARRANTIES OF MERCHANTABILITY AND FITNESS FOR A PARTICULAR PURPOSE ARE DISCLAIMED. IN NO EVENT SHALL THE AUTHOR OR CONTRIBUTORS BE LIABLE FOR ANY DIRECT, INDIRECT, INCIDENTAL, SPECIAL, EXEMPLARY, OR CONSEQUENTIAL DAMAGES (INCLUDING, BUT NOT LIMITED TO, PROCUREMENT OF SUBSTITUTE GOODS OR SERVICES; LOSS OF USE, DATA, OR PROFITS; OR BUSINESS INTERRUPTION) HOWEVER CAUSED AND ON ANY THEORY OF LIABILITY, WHETHER IN CONTRACT, STRICT LIABILITY, OR TORT (INCLUDING NEGLIGENCE OR OTHERWISE) ARISING IN ANY WAY OUT OF THE USE OF THIS SOFTWARE, EVEN IF ADVISED OF THE POSSIBILITY OF SUCH DAMAGE.

BSD-like License (flex)

Flex carries the copyright used for BSD software, slightly modified because it originated at the Lawrence Berkeley (not Livermore!) Laboratory, which operates under a contract with the Department of Energy:

Copyright (c) 2001, 2002, 2003, 2004, 2005, 2006, 2007 The Flex Project.



Copyright (c) 1990, 1997 The Regents of the University of California.
All rights reserved.

This code is derived from software contributed to Berkeley by
Vern Paxson.

The United States Government has rights in this work pursuant
to contract no. DE-AC03-76SF00098 between the United States
Department of Energy and the University of California.

Redistribution and use in source and binary forms, with or without
modification, are permitted provided that the following conditions
are met:

1. Redistributions of source code must retain the above copyright
notice, this list of conditions and the following disclaimer.
2. Redistributions in binary form must reproduce the above copyright
notice, this list of conditions and the following disclaimer in the
documentation and/or other materials provided with the distribution.

Neither the name of the University nor the names of its contributors
may be used to endorse or promote products derived from this software
without specific prior written permission.

THIS SOFTWARE IS PROVIDED ``AS IS'' AND WITHOUT ANY EXPRESS OR
IMPLIED WARRANTIES, INCLUDING, WITHOUT LIMITATION, THE IMPLIED
WARRANTIES OF MERCHANTABILITY AND FITNESS FOR A PARTICULAR
PURPOSE.

This basically says "do whatever you please with this software except
remove this notice or take advantage of the University's (or the flex
authors') name".

Note that the "flex.ski" scanner skeleton carries no copyright notice.
You are free to do whatever you please with scanners generated using flex;
for them, you are not even bound by the above copyright.

BSD-like License (iperf)

Redistribution and use in source and binary forms, with or without modification, are permitted provided that the following conditions are met:

(1) Redistributions of source code must retain the above copyright notice, this list of conditions and the following disclaimer.

(2) Redistributions in binary form must reproduce the above copyright notice, this list of conditions and the following disclaimer in the documentation and/or other materials provided with the distribution.

(3) Neither the name of the University of California, Lawrence Berkeley National Laboratory, U.S. Dept. of Energy nor the names of its contributors may be used to endorse or promote products derived from this software without specific prior written permission.

THIS SOFTWARE IS PROVIDED BY THE COPYRIGHT HOLDERS AND CONTRIBUTORS "AS IS" AND

ANY EXPRESS OR IMPLIED WARRANTIES, INCLUDING, BUT NOT LIMITED TO, THE IMPLIED WARRANTIES OF MERCHANTABILITY AND FITNESS FOR A PARTICULAR PURPOSE ARE DISCLAIMED. IN NO EVENT SHALL THE COPYRIGHT OWNER OR CONTRIBUTORS BE LIABLE FOR

ANY DIRECT, INDIRECT, INCIDENTAL, SPECIAL, EXEMPLARY, OR CONSEQUENTIAL DAMAGES (INCLUDING, BUT NOT LIMITED TO, PROCUREMENT OF SUBSTITUTE GOODS OR SERVICES; LOSS OF USE, DATA, OR PROFITS; OR BUSINESS INTERRUPTION) HOWEVER CAUSED AND ON ANY THEORY OF LIABILITY, WHETHER IN CONTRACT, STRICT LIABILITY, OR TORT (INCLUDING NEGLIGENCE OR OTHERWISE) ARISING IN ANY WAY OUT OF THE USE OF THIS SOFTWARE, EVEN IF ADVISED OF THE POSSIBILITY OF SUCH DAMAGE.

You are under no obligation whatsoever to provide any bug fixes, patches, or upgrades to the features, functionality or performance of the source code ("Enhancements") to anyone; however, if you choose to make your Enhancements available either publicly, or directly to Lawrence Berkeley National Laboratory, without imposing a separate written license agreement for such Enhancements, then you hereby grant the following license: a non-exclusive, royalty-free perpetual license to install, use, modify, prepare derivative



works, incorporate into other computer software, distribute, and sublicense such enhancements or derivative works thereof, in binary and source code form.

=====

This software contains source code (src/cjson.{c,h}) that is:

Copyright (c) 2009 Dave Gamble

Permission is hereby granted, free of charge, to any person obtaining a copy of this software and associated documentation files (the "Software"), to deal in the Software without restriction, including without limitation the rights to use, copy, modify, merge, publish, distribute, sublicense, and/or sell copies of the Software, and to permit persons to whom the Software is furnished to do so, subject to the following conditions:

The above copyright notice and this permission notice shall be included in all copies or substantial portions of the Software.

THE SOFTWARE IS PROVIDED "AS IS", WITHOUT WARRANTY OF ANY KIND, EXPRESS OR IMPLIED, INCLUDING BUT NOT LIMITED TO THE WARRANTIES OF MERCHANTABILITY, FITNESS FOR A PARTICULAR PURPOSE AND NONINFRINGEMENT. IN NO EVENT SHALL THE AUTHORS OR COPYRIGHT HOLDERS BE LIABLE FOR ANY CLAIM, DAMAGES OR OTHER LIABILITY, WHETHER IN AN ACTION OF CONTRACT, TORT OR OTHERWISE, ARISING FROM, OUT OF OR IN CONNECTION WITH THE SOFTWARE OR THE USE OR OTHER DEALINGS IN THE SOFTWARE.

=====

This software contains source code (src/net.{c,h}) that is:

This software was developed as part of a project at MIT.

Copyright (c) 2005-2007 Russ Cox,
Massachusetts Institute of Technology

Permission is hereby granted, free of charge, to any person obtaining a copy of this software and associated documentation files (the "Software"), to deal in the Software without restriction, including without limitation the rights to use, copy, modify, merge, publish, distribute, sublicense, and/or sell copies of the Software, and to permit persons to whom the Software is furnished to do so, subject to the following conditions:

The above copyright notice and this permission notice shall be included in all copies or substantial portions of the Software.

THE SOFTWARE IS PROVIDED "AS IS", WITHOUT WARRANTY OF ANY KIND, EXPRESS OR IMPLIED, INCLUDING BUT NOT LIMITED TO THE WARRANTIES OF MERCHANTABILITY, FITNESS FOR A PARTICULAR PURPOSE AND NONINFRINGEMENT. IN NO EVENT SHALL THE AUTHORS OR COPYRIGHT HOLDERS BE LIABLE FOR ANY CLAIM, DAMAGES OR OTHER LIABILITY, WHETHER IN AN ACTION OF CONTRACT, TORT OR OTHERWISE, ARISING FROM, OUT OF OR IN CONNECTION WITH THE SOFTWARE OR THE USE OR OTHER DEALINGS IN THE SOFTWARE.

===

Contains parts of an earlier library that has:

```
/*
 * The authors of this software are Rob Pike, Sape Mullender, and Russ Cox
 * Copyright (c) 2003 by Lucent Technologies.
 * Permission to use, copy, modify, and distribute this software for any
 * purpose without fee is hereby granted, provided that this entire notice
 * is included in all copies of any software which is or includes a copy
 * or modification of this software and in all copies of the supporting
 * documentation for such software.
 * THIS SOFTWARE IS BEING PROVIDED "AS IS", WITHOUT ANY EXPRESS OR IMPLIED
 * WARRANTY. IN PARTICULAR, NEITHER THE AUTHORS NOR LUCENT TECHNOLOGIES MAKE
 * ANY
 * REPRESENTATION OR WARRANTY OF ANY KIND CONCERNING THE MERCHANTABILITY
 * OF THIS SOFTWARE OR ITS FITNESS FOR ANY PARTICULAR PURPOSE.
 */
```

=====

This software contains source code (src/queue.h) that is:

```
/*
 * Copyright (c) 1991, 1993
 * The Regents of the University of California. All rights reserved.
 */
```



* Redistribution and use in source and binary forms, with or without
 * modification, are permitted provided that the following conditions
 * are met:
 * 1. Redistributions of source code must retain the above copyright
 * notice, this list of conditions and the following disclaimer.
 * 2. Redistributions in binary form must reproduce the above copyright
 * notice, this list of conditions and the following disclaimer in the
 * documentation and/or other materials provided with the distribution.
 * 3. Neither the name of the University nor the names of its contributors
 * may be used to endorse or promote products derived from this software
 * without specific prior written permission.

* THIS SOFTWARE IS PROVIDED BY THE REGENTS AND CONTRIBUTORS ``AS IS'' AND
 * ANY EXPRESS OR IMPLIED WARRANTIES, INCLUDING, BUT NOT LIMITED TO, THE
 * IMPLIED WARRANTIES OF MERCHANTABILITY AND FITNESS FOR A PARTICULAR PURPOSE
 * ARE DISCLAIMED. IN NO EVENT SHALL THE REGENTS OR CONTRIBUTORS BE LIABLE
 * FOR ANY DIRECT, INDIRECT, INCIDENTAL, SPECIAL, EXEMPLARY, OR CONSEQUENTIAL
 * DAMAGES (INCLUDING, BUT NOT LIMITED TO, PROCUREMENT OF SUBSTITUTE GOODS
 * OR SERVICES; LOSS OF USE, DATA, OR PROFITS; OR BUSINESS INTERRUPTION)
 * HOWEVER CAUSED AND ON ANY THEORY OF LIABILITY, WHETHER IN CONTRACT, STRICT
 * LIABILITY, OR TORT (INCLUDING NEGLIGENCE OR OTHERWISE) ARISING IN ANY WAY
 * OUT OF THE USE OF THIS SOFTWARE, EVEN IF ADVISED OF THE POSSIBILITY OF
 * SUCH DAMAGE.

* @(#)queue.h 8.5 (Berkeley) 8/20/94

*/

=====

This software contains source code (src/tcp_window_size.{c,h}) that is:

/*-----

* Copyright (c) 1999,2000,2001,2002,2003
 * The Board of Trustees of the University of Illinois
 * All Rights Reserved.

*-----

* Permission is hereby granted, free of charge, to any person



- * obtaining a copy of this software (lperf) and associated
- * documentation files (the "Software"), to deal in the Software
- * without restriction, including without limitation the
- * rights to use, copy, modify, merge, publish, distribute,
- * sublicense, and/or sell copies of the Software, and to permit
- * persons to whom the Software is furnished to do
- * so, subject to the following conditions:
- *
- *
- * Redistributions of source code must retain the above
- * copyright notice, this list of conditions and
- * the following disclaimers.
- *
- *
- * Redistributions in binary form must reproduce the above
- * copyright notice, this list of conditions and the following
- * disclaimers in the documentation and/or other materials
- * provided with the distribution.
- *
- *
- * Neither the names of the University of Illinois, NCSA,
- * nor the names of its contributors may be used to endorse
- * or promote products derived from this Software without
- * specific prior written permission.
- *
- * THE SOFTWARE IS PROVIDED "AS IS", WITHOUT WARRANTY OF ANY KIND,
- * EXPRESS OR IMPLIED, INCLUDING BUT NOT LIMITED TO THE WARRANTIES
- * OF MERCHANTABILITY, FITNESS FOR A PARTICULAR PURPOSE AND
- * NONINFRINGEMENT. IN NO EVENT SHALL THE CONTRIBUTORS OR COPYRIGHT
- * HOLDERS BE LIABLE FOR ANY CLAIM, DAMAGES OR OTHER LIABILITY,
- * WHETHER IN AN ACTION OF CONTRACT, TORT OR OTHERWISE,
- * ARISING FROM, OUT OF OR IN CONNECTION WITH THE
- * SOFTWARE OR THE USE OR OTHER DEALINGS IN THE SOFTWARE.
- *
- _____
- * National Laboratory for Applied Network Research
- * National Center for Supercomputing Applications
- * University of Illinois at Urbana-Champaign



```
* http://www.ncsa.uiuc.edu
*
* -----
*
* tcp_window_size.c
* by Mark Gates <mgates@nlanr.net>
* -----
* set/getsockopt
* ----- */
```

====

This software contains source code (src/units.{c,h}) that is:

```
/*-----
* Copyright (c) 1999,2000,2001,2002,2003
* The Board of Trustees of the University of Illinois
* All Rights Reserved.
*-----
* Permission is hereby granted, free of charge, to any person
* obtaining a copy of this software (lperf) and associated
* documentation files (the "Software"), to deal in the Software
* without restriction, including without limitation the
* rights to use, copy, modify, merge, publish, distribute,
* sublicense, and/or sell copies of the Software, and to permit
* persons to whom the Software is furnished to do
* so, subject to the following conditions:
*
*
* Redistributions of source code must retain the above
* copyright notice, this list of conditions and
* the following disclaimers.
*
*
* Redistributions in binary form must reproduce the above
* copyright notice, this list of conditions and the following
* disclaimers in the documentation and/or other materials
* provided with the distribution.
```



*
 *
 * Neither the names of the University of Illinois, NCSA,
 * nor the names of its contributors may be used to endorse
 * or promote products derived from this Software without
 * specific prior written permission.
 *
 * THE SOFTWARE IS PROVIDED "AS IS", WITHOUT WARRANTY OF ANY KIND,
 * EXPRESS OR IMPLIED, INCLUDING BUT NOT LIMITED TO THE WARRANTIES
 * OF MERCHANTABILITY, FITNESS FOR A PARTICULAR PURPOSE AND
 * NONINFRINGEMENT. IN NO EVENT SHALL THE CONTRIBUTORS OR COPYRIGHT
 * HOLDERS BE LIABLE FOR ANY CLAIM, DAMAGES OR OTHER LIABILITY,
 * WHETHER IN AN ACTION OF CONTRACT, TORT OR OTHERWISE,
 * ARISING FROM, OUT OF OR IN CONNECTION WITH THE
 * SOFTWARE OR THE USE OR OTHER DEALINGS IN THE SOFTWARE.

* National Laboratory for Applied Network Research
 * National Center for Supercomputing Applications
 * University of Illinois at Urbana-Champaign
 * <http://www.ncsa.uiuc.edu>

*
 * stdio.c
 * by Mark Gates <mgates@nlanr.net>
 * and Ajay Tirumalla <tirumala@ncsa.uiuc.edu>
 * -----
 * input and output numbers, converting with kilo, mega, giga
 * ----- */

=====

This software contains source code (src/portable_endian.h) that is:

```
// "License": Public Domain
// I, Mathias Panzenböck, place this file hereby into the public domain. Use it at your own risk
for whatever you like.
```

=====

BSD-like License (ppp)

Redistribution and use in source and binary forms, with or without modification, are permitted provided that the following conditions are met:

1. Redistributions of source code must retain the above copyright notice, this list of conditions and the following disclaimer.
2. Redistributions in binary form must reproduce the above copyright notice, this list of conditions and the following disclaimer in the documentation and/or other materials provided with the distribution.
3. The names of the authors of this software must not be used to endorse or promote products derived from this software without prior written permission.
4. Redistributions of any form whatsoever must retain the following acknowledgment:
"This product includes software developed by Pedro Roque Marques <pedro_m@yahoo.com>"

THE AUTHORS OF THIS SOFTWARE DISCLAIM ALL WARRANTIES WITH REGARD TO THIS SOFTWARE, INCLUDING ALL IMPLIED WARRANTIES OF MERCHANTABILITY AND FITNESS, IN NO EVENT SHALL THE AUTHORS BE LIABLE FOR ANY SPECIAL, INDIRECT OR CONSEQUENTIAL DAMAGES OR ANY DAMAGES WHATSOEVER RESULTING FROM LOSS OF USE, DATA OR PROFITS, WHETHER IN AN ACTION OF CONTRACT, NEGLIGENCE OR OTHER TORTIOUS ACTION, ARISING OUT OF OR IN CONNECTION WITH THE USE OR PERFORMANCE OF THIS SOFTWARE.

BSD-like License (tcp-wrappers)

This material was originally written and compiled by Wietse Venema at Eindhoven University of Technology, The Netherlands, in 1990, 1991, 1992, 1993, 1994 and 1995.



Redistribution and use in source and binary forms are permitted provided that this entire copyright notice is duplicated in all such copies.

This software is provided "as is" and without any expressed or implied warranties, including, without limitation, the implied warranties of merchantability and fitness for any particular purpose.

BSL-1.0

Boost Software License - Version 1.0 - August 17th, 2003

Permission is hereby granted, free of charge, to any person or organization obtaining a copy of the software and accompanying documentation covered by this license (the "Software") to use, reproduce, display, distribute, execute, and transmit the Software, and to prepare derivative works of the Software, and to permit third-parties to whom the Software is furnished to do so, all subject to the following:

The copyright notices in the Software and this entire statement, including the above license grant, this restriction and the following disclaimer, must be included in all copies of the Software, in whole or in part, and all derivative works of the Software, unless such copies or derivative works are solely in the form of machine-executable object code generated by a source language processor.

THE SOFTWARE IS PROVIDED "AS IS", WITHOUT WARRANTY OF ANY KIND, EXPRESS OR IMPLIED, INCLUDING BUT NOT LIMITED TO THE WARRANTIES OF MERCHANTABILITY, FITNESS FOR A PARTICULAR PURPOSE, TITLE AND NON-INFRINGEMENT. IN NO EVENT SHALL THE COPYRIGHT HOLDERS OR ANYONE DISTRIBUTING THE SOFTWARE BE LIABLE FOR ANY DAMAGES OR OTHER LIABILITY, WHETHER IN CONTRACT, TORT OR OTHERWISE, ARISING FROM, OUT OF OR IN CONNECTION WITH THE SOFTWARE OR THE USE OR OTHER DEALINGS IN THE SOFTWARE.

FFT License

You may use, copy, modify and distribute this code for any purpose (include commercial use) and without fee. Please refer to this package when you modify this code.

FTL



The FreeType Project LICENSE

2006-Jan-27

Copyright 1996-2002, 2006 by David Turner, Robert Wilhelm, and Werner Lemberg

Introduction

The FreeType Project is distributed in several archive packages; some of them may contain, in addition to the FreeType font engine, various tools and contributions which rely on, or relate to, the FreeType Project.

This license applies to all files found in such packages, and which do not fall under their own explicit license. The license affects thus the FreeType font engine, the test programs, documentation and makefiles, at the very least.

This license was inspired by the BSD, Artistic, and IJG (Independent JPEG Group) licenses, which all encourage inclusion and use of free software in commercial and freeware products alike. As a consequence, its main points are that:

- o We don't promise that this software works. However, we will be interested in any kind of bug reports. (' as is' distribution)
- o You can use this software for whatever you want, in parts or full form, without having to pay us. (' royalty-free' usage)
- o You may not pretend that you wrote this software. If you use it, or only parts of it, in a program, you must acknowledge somewhere in your documentation that you have used the FreeType code. (' credits')

We specifically permit and encourage the inclusion of this software, with or without modifications, in commercial products. We disclaim all warranties covering The FreeType Project and assume no liability related to The FreeType Project.

Finally, many people asked us for a preferred form for a credit/disclaimer to use in compliance with this license. We thus encourage you to use the following text:

"" Portions of this software are copyright © <year> The FreeType Project (www.freetype.org). All rights reserved. ""



Please replace <year> with the value from the FreeType version you actually use.

Legal Terms

0. Definitions

Throughout this license, the terms 'package', 'FreeType Project', and 'FreeType archive' refer to the set of files originally distributed by the authors (David Turner, Robert Wilhelm, and Werner Lemberg) as the 'FreeType Project', be they named as alpha, beta or final release.

'You' refers to the licensee, or person using the project, where 'using' is a generic term including compiling the project's source code as well as linking it to form a 'program' or 'executable'. This program is referred to as 'a program using the FreeType engine'.

This license applies to all files distributed in the original FreeType Project, including all source code, binaries and documentation, unless otherwise stated in the file in its original, unmodified form as distributed in the original archive. If you are unsure whether or not a particular file is covered by this license, you must contact us to verify this.

The FreeType Project is copyright (C) 1996-2000 by David Turner, Robert Wilhelm, and Werner Lemberg. All rights reserved except as specified below.

1. No Warranty

THE FREETYPE PROJECT IS PROVIDED 'AS IS' WITHOUT WARRANTY OF ANY KIND, EITHER EXPRESS OR IMPLIED, INCLUDING, BUT NOT LIMITED TO, WARRANTIES OF MERCHANTABILITY AND FITNESS FOR A PARTICULAR PURPOSE. IN NO EVENT WILL ANY OF THE AUTHORS OR COPYRIGHT HOLDERS BE LIABLE FOR ANY DAMAGES CAUSED BY THE USE OR THE INABILITY TO USE, OF THE FREETYPE PROJECT.

2. Redistribution

This license grants a worldwide, royalty-free, perpetual and irrevocable right and license to use, execute, perform, compile, display, copy, create derivative works of, distribute and sublicense the FreeType Project (in both source and object code forms) and derivative works thereof for any purpose; and to authorize others to exercise some or all of the rights granted herein, subject to the following conditions:

- o Redistribution of source code must retain this license file ('FTL.TXT') unaltered; any additions, deletions or changes to the original files must be clearly indicated in accompanying documentation. The copyright notices of the unaltered, original files must be preserved in all

copies of source files.

o Redistribution in binary form must provide a disclaimer that states that the software is based in part of the work of the FreeType Team, in the distribution documentation. We also encourage you to put an URL to the FreeType web page in your documentation, though this isn't mandatory.

These conditions apply to any software derived from or based on the FreeType Project, not just the unmodified files. If you use our work, you must acknowledge us. However, no fee need be paid to us.

3. Advertising

Neither the FreeType authors and contributors nor you shall use the name of the other for commercial, advertising, or promotional purposes without specific prior written permission.

We suggest, but do not require, that you use one or more of the following phrases to refer to this software in your documentation or advertising materials: `FreeType Project`, `FreeType Engine`, `FreeType library`, or `FreeType Distribution`.

As you have not signed this license, you are not required to accept it. However, as the FreeType Project is copyrighted material, only this license, or another one contracted with the authors, grants you the right to use, distribute, and modify it. Therefore, by using, distributing, or modifying the FreeType Project, you indicate that you understand and accept all the terms of this license.

4. Contacts

There are two mailing lists related to FreeType:

o freetype@nongnu.org

Discusses general use and applications of FreeType, as well as future and wanted additions to the library and distribution. If you are looking for support, start in this list if you haven't found anything to help you in the documentation.

o freetype-devel@nongnu.org

Discusses bugs, as well as engine internals, design issues, specific licenses, porting, etc.

Our home page can be found at

<http://www.freetype.org>

--- end of FTL.TXT ---

GNU General Public License v2.0 w/OpenSSL Exception

GNU GENERAL PUBLIC LICENSE

Version 2, June 1991

Copyright (C) 1989, 1991 Free Software Foundation, Inc.
51 Franklin Street, Fifth Floor, Boston, MA 02110-1301, USA

Everyone is permitted to copy and distribute verbatim copies of this license document, but changing it is not allowed.

Preamble

The licenses for most software are designed to take away your freedom to share and change it. By contrast, the GNU General Public License is intended to guarantee your freedom to share and change free software--to make sure the software is free for all its users. This General Public License applies to most of the Free Software Foundation's software and to any other program whose authors commit to using it. (Some other Free Software Foundation software is covered by the GNU Lesser General Public License instead.) You can apply it to your programs, too.

When we speak of free software, we are referring to freedom, not price. Our General Public Licenses are designed to make sure that you have the freedom to distribute copies of free software (and charge for this service if you wish), that you receive source code or can get it if you want it, that you can change the software or use pieces of it in new free programs; and that you know you can do these things.

To protect your rights, we need to make restrictions that forbid anyone to deny you these rights or to ask you to surrender the rights. These restrictions translate to certain responsibilities for you if you distribute copies of the software, or if you modify it.

For example, if you distribute copies of such a program, whether gratis or for a fee, you must give the recipients all the rights that you have. You must make sure that they, too, receive or can get the source code. And you must show them these terms so they know their rights.

We protect your rights with two steps: (1) copyright the software, and (2) offer you this license which gives you legal permission to copy, distribute and/or modify the software.

Also, for each author's protection and ours, we want to make certain that everyone understands that there is no warranty for this free software. If the software is modified by someone else and passed on, we want its recipients to know that what they have is not the original, so that any problems introduced by others will not reflect on the original authors' reputations.

Finally, any free program is threatened constantly by software patents. We wish to avoid the danger that redistributors of a free program will individually obtain patent licenses, in effect making the program proprietary. To prevent this, we have made it clear that any patent must be licensed for everyone's free use or not licensed at all.

The precise terms and conditions for copying, distribution and modification follow.

TERMS AND CONDITIONS FOR COPYING, DISTRIBUTION AND MODIFICATION

0. This License applies to any program or other work which contains a notice placed by the copyright holder saying it may be distributed under the terms of this General Public License. The "Program", below, refers to any such program or work, and a "work based on the Program" means either the Program or any derivative work under copyright law: that is to say, a work containing the Program or a portion of it, either verbatim or with modifications and/or translated into another language. (Hereinafter, translation is included without limitation in the term "modification".) Each licensee is addressed as "you".

Activities other than copying, distribution and modification are not covered by this License; they are outside its scope. The act of running the Program is not restricted, and the output from the Program is covered only if its contents constitute a work based on the Program (independent of having been made by running the Program). Whether that is true depends on what the Program does.

1. You may copy and distribute verbatim copies of the Program's source code as you receive it, in any medium, provided that you conspicuously and appropriately publish on each copy an appropriate copyright notice and disclaimer of warranty; keep intact all the notices that refer to this License and to the absence of any warranty; and give any other recipients of the Program a copy of this License along with the Program.

You may charge a fee for the physical act of transferring a copy, and you may at your option offer warranty protection in exchange for a fee.

2. You may modify your copy or copies of the Program or any portion of it, thus forming a work based on the Program, and copy and distribute such modifications or work under the terms of Section 1 above, provided that you also meet all of these conditions:

- a) You must cause the modified files to carry prominent notices stating that you changed the files and the date of any change.
- b) You must cause any work that you distribute or publish, that in whole or in part contains or is derived from the Program or any part thereof, to be licensed as a whole at no charge to all third parties under the terms of this License.
- c) If the modified program normally reads commands interactively when run, you must cause it, when started running for such interactive use in the most ordinary way, to print or display an announcement including an appropriate copyright notice and a notice that there is no warranty (or else, saying that you provide a warranty) and that users may redistribute the program under these conditions, and telling the user how to view a copy of this License. (Exception: if the Program itself is interactive but does not normally print such an announcement, your work based on the Program is not required to print an announcement.)

These requirements apply to the modified work as a whole. If identifiable sections of that work are not derived from the Program, and can be reasonably considered independent and separate works in themselves, then this License, and its terms, do not apply to those sections when you distribute them as separate works. But when you distribute the same sections as part of a whole which is a work based on the Program, the distribution of the whole must be on the terms of this License, whose permissions for other licensees extend to the entire whole, and thus to each and every part regardless of who wrote it.

Thus, it is not the intent of this section to claim rights or contest your rights to work written entirely by you; rather, the intent is to exercise the right to control the distribution of derivative or collective works based on the Program.

In addition, mere aggregation of another work not based on the Program with the Program (or with a work based on the Program) on a volume of a storage or distribution medium does not bring the other work under the scope of this License.

3. You may copy and distribute the Program (or a work based on it, under Section 2) in object code or executable form under the terms of Sections 1 and 2 above provided that you also do one of the following:

- a) Accompany it with the complete corresponding machine-readable source code, which must be distributed under the terms of Sections 1 and 2 above on a medium customarily used for software interchange; or,

b) Accompany it with a written offer, valid for at least three years, to give any third party, for a charge no more than your cost of physically performing source distribution, a complete machine-readable copy of the corresponding source code, to be distributed under the terms of Sections 1 and 2 above on a medium customarily used for software interchange; or,

c) Accompany it with the information you received as to the offer to distribute corresponding source code. (This alternative is allowed only for noncommercial distribution and only if you received the program in object code or executable form with such an offer, in accord with Subsection b above.)

The source code for a work means the preferred form of the work for making modifications to it. For an executable work, complete source code means all the source code for all modules it contains, plus any associated interface definition files, plus the scripts used to control compilation and installation of the executable. However, as a special exception, the source code distributed need not include anything that is normally distributed (in either source or binary form) with the major components (compiler, kernel, and so on) of the operating system on which the executable runs, unless that component itself accompanies the executable.

If distribution of executable or object code is made by offering access to copy from a designated place, then offering equivalent access to copy the source code from the same place counts as distribution of the source code, even though third parties are not compelled to copy the source along with the object code.

4. You may not copy, modify, sublicense, or distribute the Program except as expressly provided under this License. Any attempt otherwise to copy, modify, sublicense or distribute the Program is void, and will automatically terminate your rights under this License. However, parties who have received copies, or rights, from you under this License will not have their licenses terminated so long as such parties remain in full compliance.

5. You are not required to accept this License, since you have not signed it. However, nothing else grants you permission to modify or distribute the Program or its derivative works. These actions are prohibited by law if you do not accept this License. Therefore, by modifying or distributing the Program (or any work based on the Program), you indicate your acceptance of this License to do so, and all its terms and conditions for copying, distributing or modifying the Program or works based on it.

6. Each time you redistribute the Program (or any work based on the Program), the recipient automatically receives a license from the original licensor to copy, distribute or modify the Program subject to these terms and conditions. You may not impose any further restrictions on the recipients' exercise of the rights granted herein. You are not responsible for enforcing compliance by third parties to this License.

7. If, as a consequence of a court judgment or allegation of patent infringement or for any

other reason (not limited to patent issues), conditions are imposed on you (whether by court order, agreement or otherwise) that contradict the conditions of this License, they do not excuse you from the conditions of this License. If you cannot distribute so as to satisfy simultaneously your obligations under this License and any other pertinent obligations, then as a consequence you may not distribute the Program at all. For example, if a patent license would not permit royalty-free redistribution of the Program by all those who receive copies directly or indirectly through you, then the only way you could satisfy both it and this License would be to refrain entirely from distribution of the Program.

If any portion of this section is held invalid or unenforceable under any particular circumstance, the balance of the section is intended to apply and the section as a whole is intended to apply in other circumstances.

It is not the purpose of this section to induce you to infringe any patents or other property right claims or to contest validity of any such claims; this section has the sole purpose of protecting the integrity of the free software distribution system, which is implemented by public license practices. Many people have made generous contributions to the wide range of software distributed through that system in reliance on consistent application of that system; it is up to the author/donor to decide if he or she is willing to distribute software through any other system and a licensee cannot impose that choice.

This section is intended to make thoroughly clear what is believed to be a consequence of the rest of this License.

8. If the distribution and/or use of the Program is restricted in certain countries either by patents or by copyrighted interfaces, the original copyright holder who places the Program under this License may add an explicit geographical distribution limitation excluding those countries, so that distribution is permitted only in or among countries not thus excluded. In such case, this License incorporates the limitation as if written in the body of this License.

9. The Free Software Foundation may publish revised and/or new versions of the General Public License from time to time. Such new versions will be similar in spirit to the present version, but may differ in detail to address new problems or concerns.

Each version is given a distinguishing version number. If the Program specifies a version number of this License which applies to it and "any later version", you have the option of following the terms and conditions either of that version or of any later version published by the Free Software Foundation. If the Program does not specify a version number of this License, you may choose any version ever published by the Free Software Foundation.

10. If you wish to incorporate parts of the Program into other free programs whose distribution conditions are different, write to the author to ask for permission. For software which is copyrighted by the Free Software Foundation, write to the Free Software Foundation;

we sometimes make exceptions for this. Our decision will be guided by the two goals of preserving the free status of all derivatives of our free software and of promoting the sharing and reuse of software generally.

NO WARRANTY

11. BECAUSE THE PROGRAM IS LICENSED FREE OF CHARGE, THERE IS NO WARRANTY FOR THE PROGRAM, TO THE EXTENT PERMITTED BY APPLICABLE LAW. EXCEPT WHEN OTHERWISE STATED IN WRITING THE COPYRIGHT HOLDERS AND/OR OTHER PARTIES PROVIDE THE PROGRAM "AS IS" WITHOUT WARRANTY OF ANY KIND, EITHER EXPRESSED OR IMPLIED, INCLUDING, BUT NOT LIMITED TO, THE IMPLIED WARRANTIES OF MERCHANTABILITY AND FITNESS FOR A PARTICULAR PURPOSE. THE ENTIRE RISK AS TO THE QUALITY AND PERFORMANCE OF THE PROGRAM IS WITH YOU. SHOULD THE PROGRAM PROVE DEFECTIVE, YOU ASSUME THE COST OF ALL NECESSARY SERVICING, REPAIR OR CORRECTION.

12. IN NO EVENT UNLESS REQUIRED BY APPLICABLE LAW OR AGREED TO IN WRITING WILL ANY COPYRIGHT HOLDER, OR ANY OTHER PARTY WHO MAY MODIFY AND/OR REDISTRIBUTE THE PROGRAM AS PERMITTED ABOVE, BE LIABLE TO YOU FOR DAMAGES, INCLUDING ANY GENERAL, SPECIAL, INCIDENTAL OR CONSEQUENTIAL DAMAGES ARISING OUT OF THE USE OR INABILITY TO USE THE PROGRAM (INCLUDING BUT NOT LIMITED TO LOSS OF DATA OR DATA BEING RENDERED INACCURATE OR LOSSES SUSTAINED BY YOU OR THIRD PARTIES OR A FAILURE OF THE PROGRAM TO OPERATE WITH ANY OTHER PROGRAMS), EVEN IF SUCH HOLDER OR OTHER PARTY HAS BEEN ADVISED OF THE POSSIBILITY OF SUCH DAMAGES.

END OF TERMS AND CONDITIONS

How to Apply These Terms to Your New Programs

If you develop a new program, and you want it to be of the greatest possible use to the public, the best way to achieve this is to make it free software which everyone can redistribute and change under these terms.

To do so, attach the following notices to the program. It is safest to attach them to the start of each source file to most effectively convey the exclusion of warranty; and each file should have at least the "copyright" line and a pointer to where the full notice is found.

One line to give the program's name and an idea of what it does. Copyright (C) yyyy name of author

This program is free software; you can redistribute it and/or modify it under the terms of the GNU General Public License as published by the Free Software Foundation; either version 2 of



the License, or (at your option) any later version.

This program is distributed in the hope that it will be useful, but WITHOUT ANY WARRANTY; without even the implied warranty of MERCHANTABILITY or FITNESS FOR A PARTICULAR PURPOSE. See the GNU General Public License for more details.

You should have received a copy of the GNU General Public License along with this program; if not, write to the Free Software Foundation, Inc., 51 Franklin Street, Fifth Floor, Boston, MA 02110-1301, USA. Also add information on how to contact you by electronic and paper mail.

If the program is interactive, make it output a short notice like this when it starts in an interactive mode:

```
Gnomovision version 69, Copyright (C) year name of author Gnomovision comes with
ABSOLUTELY NO WARRANTY; for details type `show w'. This is free software, and you are
welcome to redistribute it under certain conditions; type `show c' for details.
```

The hypothetical commands ``show w'` and ``show c'` should show the appropriate parts of the General Public License. Of course, the commands you use may be called something other than ``show w'` and ``show c'`; they could even be mouse-clicks or menu items--whatever suits your program.

You should also get your employer (if you work as a programmer) or your school, if any, to sign a "copyright disclaimer" for the program, if necessary. Here is a sample; alter the names:

```
Yoyodyne, Inc., hereby disclaims all copyright interest in the program `Gnomovision' (which
makes passes at compilers) written by James Hacker.
```

signature of Ty Coon, 1 April 1989 Ty Coon, President of Vice

In addition, as a special exception, the copyright holders give permission to link the code of portions of this program with the OpenSSL library under certain conditions as described in each individual source file, and distribute linked combinations including the two.

You must obey the GNU General Public License in all respects for all of the code used other than OpenSSL. If you modify file(s) with this exception, you may extend this exception to your version of the file(s), but you are not obligated to do so. If you do not wish to do so, delete this exception statement from your version. If you delete this exception statement from all source files in the program, then also delete it here.

GPL-2.0

GNU GENERAL PUBLIC LICENSE

Version 2, June 1991

Copyright (C) 1989, 1991 Free Software Foundation, Inc.
51 Franklin Street, Fifth Floor, Boston, MA 02110-1301, USA

Everyone is permitted to copy and distribute verbatim copies of this license document, but changing it is not allowed.

Preamble

The licenses for most software are designed to take away your freedom to share and change it. By contrast, the GNU General Public License is intended to guarantee your freedom to share and change free software--to make sure the software is free for all its users. This General Public License applies to most of the Free Software Foundation's software and to any other program whose authors commit to using it. (Some other Free Software Foundation software is covered by the GNU Lesser General Public License instead.) You can apply it to your programs, too.

When we speak of free software, we are referring to freedom, not price. Our General Public Licenses are designed to make sure that you have the freedom to distribute copies of free software (and charge for this service if you wish), that you receive source code or can get it if you want it, that you can change the software or use pieces of it in new free programs; and that you know you can do these things.

To protect your rights, we need to make restrictions that forbid anyone to deny you these rights or to ask you to surrender the rights. These restrictions translate to certain responsibilities for you if you distribute copies of the software, or if you modify it.

For example, if you distribute copies of such a program, whether gratis or for a fee, you must give the recipients all the rights that you have. You must make sure that they, too, receive or can get the source code. And you must show them these terms so they know their rights.

We protect your rights with two steps: (1) copyright the software, and (2) offer you this license which gives you legal permission to copy, distribute and/or modify the software.

Also, for each author's protection and ours, we want to make certain that everyone understands that there is no warranty for this free software. If the software is modified by someone else and passed on, we want its recipients to know that what they have is not the

original, so that any problems introduced by others will not reflect on the original authors' reputations.

Finally, any free program is threatened constantly by software patents. We wish to avoid the danger that redistributors of a free program will individually obtain patent licenses, in effect making the program proprietary. To prevent this, we have made it clear that any patent must be licensed for everyone's free use or not licensed at all.

The precise terms and conditions for copying, distribution and modification follow.

TERMS AND CONDITIONS FOR COPYING, DISTRIBUTION AND MODIFICATION

0. This License applies to any program or other work which contains a notice placed by the copyright holder saying it may be distributed under the terms of this General Public License. The "Program", below, refers to any such program or work, and a "work based on the Program" means either the Program or any derivative work under copyright law: that is to say, a work containing the Program or a portion of it, either verbatim or with modifications and/or translated into another language. (Hereinafter, translation is included without limitation in the term "modification".) Each licensee is addressed as "you".

Activities other than copying, distribution and modification are not covered by this License; they are outside its scope. The act of running the Program is not restricted, and the output from the Program is covered only if its contents constitute a work based on the Program (independent of having been made by running the Program). Whether that is true depends on what the Program does.

1. You may copy and distribute verbatim copies of the Program's source code as you receive it, in any medium, provided that you conspicuously and appropriately publish on each copy an appropriate copyright notice and disclaimer of warranty; keep intact all the notices that refer to this License and to the absence of any warranty; and give any other recipients of the Program a copy of this License along with the Program.

You may charge a fee for the physical act of transferring a copy, and you may at your option offer warranty protection in exchange for a fee.

2. You may modify your copy or copies of the Program or any portion of it, thus forming a work based on the Program, and copy and distribute such modifications or work under the terms of Section 1 above, provided that you also meet all of these conditions:

a) You must cause the modified files to carry prominent notices stating that you changed the files and the date of any change.

b) You must cause any work that you distribute or publish, that in whole or in part contains or is derived from the Program or any part thereof, to be licensed as a whole at no charge to all third parties under the terms of this License.

c) If the modified program normally reads commands interactively when run, you must cause it, when started running for such interactive use in the most ordinary way, to print or display an announcement including an appropriate copyright notice and a notice that there is no warranty (or else, saying that you provide a warranty) and that users may redistribute the program under these conditions, and telling the user how to view a copy of this License. (Exception: if the Program itself is interactive but does not normally print such an announcement, your work based on the Program is not required to print an announcement.)

These requirements apply to the modified work as a whole. If identifiable sections of that work are not derived from the Program, and can be reasonably considered independent and separate works in themselves, then this License, and its terms, do not apply to those sections when you distribute them as separate works. But when you distribute the same sections as part of a whole which is a work based on the Program, the distribution of the whole must be on the terms of this License, whose permissions for other licensees extend to the entire whole, and thus to each and every part regardless of who wrote it.

Thus, it is not the intent of this section to claim rights or contest your rights to work written entirely by you; rather, the intent is to exercise the right to control the distribution of derivative or collective works based on the Program.

In addition, mere aggregation of another work not based on the Program with the Program (or with a work based on the Program) on a volume of a storage or distribution medium does not bring the other work under the scope of this License.

3. You may copy and distribute the Program (or a work based on it, under Section 2) in object code or executable form under the terms of Sections 1 and 2 above provided that you also do one of the following:

a) Accompany it with the complete corresponding machine-readable source code, which must be distributed under the terms of Sections 1 and 2 above on a medium customarily used for software interchange; or,

b) Accompany it with a written offer, valid for at least three years, to give any third party, for a charge no more than your cost of physically performing source distribution, a complete machine-readable copy of the corresponding source code, to be distributed under the terms of Sections 1 and 2 above on a medium customarily used for software interchange; or,

c) Accompany it with the information you received as to the offer to distribute corresponding source code. (This alternative is allowed only for noncommercial distribution and only if you

received the program in object code or executable form with such an offer, in accord with Subsection b above.)

The source code for a work means the preferred form of the work for making modifications to it. For an executable work, complete source code means all the source code for all modules it contains, plus any associated interface definition files, plus the scripts used to control compilation and installation of the executable. However, as a special exception, the source code distributed need not include anything that is normally distributed (in either source or binary form) with the major components (compiler, kernel, and so on) of the operating system on which the executable runs, unless that component itself accompanies the executable.

If distribution of executable or object code is made by offering access to copy from a designated place, then offering equivalent access to copy the source code from the same place counts as distribution of the source code, even though third parties are not compelled to copy the source along with the object code.

4. You may not copy, modify, sublicense, or distribute the Program except as expressly provided under this License. Any attempt otherwise to copy, modify, sublicense or distribute the Program is void, and will automatically terminate your rights under this License. However, parties who have received copies, or rights, from you under this License will not have their licenses terminated so long as such parties remain in full compliance.

5. You are not required to accept this License, since you have not signed it. However, nothing else grants you permission to modify or distribute the Program or its derivative works. These actions are prohibited by law if you do not accept this License. Therefore, by modifying or distributing the Program (or any work based on the Program), you indicate your acceptance of this License to do so, and all its terms and conditions for copying, distributing or modifying the Program or works based on it.

6. Each time you redistribute the Program (or any work based on the Program), the recipient automatically receives a license from the original licensor to copy, distribute or modify the Program subject to these terms and conditions. You may not impose any further restrictions on the recipients' exercise of the rights granted herein. You are not responsible for enforcing compliance by third parties to this License.

7. If, as a consequence of a court judgment or allegation of patent infringement or for any other reason (not limited to patent issues), conditions are imposed on you (whether by court order, agreement or otherwise) that contradict the conditions of this License, they do not excuse you from the conditions of this License. If you cannot distribute so as to satisfy simultaneously your obligations under this License and any other pertinent obligations, then as a consequence you may not distribute the Program at all. For example, if a patent license would not permit royalty-free redistribution of the Program by all those who receive copies directly or indirectly through you, then the only way you could satisfy both it and this License would be to refrain entirely from distribution of the Program.

If any portion of this section is held invalid or unenforceable under any particular circumstance, the balance of the section is intended to apply and the section as a whole is intended to apply in other circumstances.

It is not the purpose of this section to induce you to infringe any patents or other property right claims or to contest validity of any such claims; this section has the sole purpose of protecting the integrity of the free software distribution system, which is implemented by public license practices. Many people have made generous contributions to the wide range of software distributed through that system in reliance on consistent application of that system; it is up to the author/donor to decide if he or she is willing to distribute software through any other system and a licensee cannot impose that choice.

This section is intended to make thoroughly clear what is believed to be a consequence of the rest of this License.

8. If the distribution and/or use of the Program is restricted in certain countries either by patents or by copyrighted interfaces, the original copyright holder who places the Program under this License may add an explicit geographical distribution limitation excluding those countries, so that distribution is permitted only in or among countries not thus excluded. In such case, this License incorporates the limitation as if written in the body of this License.

9. The Free Software Foundation may publish revised and/or new versions of the General Public License from time to time. Such new versions will be similar in spirit to the present version, but may differ in detail to address new problems or concerns.

Each version is given a distinguishing version number. If the Program specifies a version number of this License which applies to it and "any later version", you have the option of following the terms and conditions either of that version or of any later version published by the Free Software Foundation. If the Program does not specify a version number of this License, you may choose any version ever published by the Free Software Foundation.

10. If you wish to incorporate parts of the Program into other free programs whose distribution conditions are different, write to the author to ask for permission. For software which is copyrighted by the Free Software Foundation, write to the Free Software Foundation; we sometimes make exceptions for this. Our decision will be guided by the two goals of preserving the free status of all derivatives of our free software and of promoting the sharing and reuse of software generally.

NO WARRANTY

11. BECAUSE THE PROGRAM IS LICENSED FREE OF CHARGE, THERE IS NO WARRANTY FOR THE PROGRAM, TO THE EXTENT PERMITTED BY APPLICABLE LAW, EXCEPT WHEN



OTHERWISE STATED IN WRITING THE COPYRIGHT HOLDERS AND/OR OTHER PARTIES PROVIDE THE PROGRAM "AS IS" WITHOUT WARRANTY OF ANY KIND, EITHER EXPRESSED OR IMPLIED, INCLUDING, BUT NOT LIMITED TO, THE IMPLIED WARRANTIES OF MERCHANTABILITY AND FITNESS FOR A PARTICULAR PURPOSE. THE ENTIRE RISK AS TO THE QUALITY AND PERFORMANCE OF THE PROGRAM IS WITH YOU. SHOULD THE PROGRAM PROVE DEFECTIVE, YOU ASSUME THE COST OF ALL NECESSARY SERVICING, REPAIR OR CORRECTION.

12. IN NO EVENT UNLESS REQUIRED BY APPLICABLE LAW OR AGREED TO IN WRITING WILL ANY COPYRIGHT HOLDER, OR ANY OTHER PARTY WHO MAY MODIFY AND/OR REDISTRIBUTE THE PROGRAM AS PERMITTED ABOVE, BE LIABLE TO YOU FOR DAMAGES, INCLUDING ANY GENERAL, SPECIAL, INCIDENTAL OR CONSEQUENTIAL DAMAGES ARISING OUT OF THE USE OR INABILITY TO USE THE PROGRAM (INCLUDING BUT NOT LIMITED TO LOSS OF DATA OR DATA BEING RENDERED INACCURATE OR LOSSES SUSTAINED BY YOU OR THIRD PARTIES OR A FAILURE OF THE PROGRAM TO OPERATE WITH ANY OTHER PROGRAMS), EVEN IF SUCH HOLDER OR OTHER PARTY HAS BEEN ADVISED OF THE POSSIBILITY OF SUCH DAMAGES.

END OF TERMS AND CONDITIONS

How to Apply These Terms to Your New Programs

If you develop a new program, and you want it to be of the greatest possible use to the public, the best way to achieve this is to make it free software which everyone can redistribute and change under these terms.

To do so, attach the following notices to the program. It is safest to attach them to the start of each source file to most effectively convey the exclusion of warranty; and each file should have at least the "copyright" line and a pointer to where the full notice is found.

One line to give the program's name and an idea of what it does. Copyright (C) yyyy name of author

This program is free software; you can redistribute it and/or modify it under the terms of the GNU General Public License as published by the Free Software Foundation; either version 2 of the License, or (at your option) any later version.

This program is distributed in the hope that it will be useful, but WITHOUT ANY WARRANTY; without even the implied warranty of MERCHANTABILITY or FITNESS FOR A PARTICULAR PURPOSE. See the GNU General Public License for more details.

You should have received a copy of the GNU General Public License along with this program; if not, write to the Free Software Foundation, Inc., 51 Franklin Street, Fifth Floor, Boston, MA



02110-1301, USA. Also add information on how to contact you by electronic and paper mail.

If the program is interactive, make it output a short notice like this when it starts in an interactive mode:

```
Gnomovision version 69, Copyright (C) year name of author Gnomovision comes with
ABSOLUTELY NO WARRANTY; for details type `show w'. This is free software, and you are
welcome to redistribute it under certain conditions; type `show c' for details.
```

The hypothetical commands ``show w'` and ``show c'` should show the appropriate parts of the General Public License. Of course, the commands you use may be called something other than ``show w'` and ``show c'`; they could even be mouse-clicks or menu items--whatever suits your program.

You should also get your employer (if you work as a programmer) or your school, if any, to sign a "copyright disclaimer" for the program, if necessary. Here is a sample; alter the names:

```
Yoyodyne, Inc., hereby disclaims all copyright interest in the program `Gnomovision' (which
makes passes at compilers) written by James Hacker.
```

signature of Ty Coon, 1 April 1989 Ty Coon, President of Vice

ICU

Permission is hereby granted, free of charge, to any person obtaining a copy of this software and associated documentation files (the "Software"), to deal in the Software without restriction, including without limitation the rights to use, copy, modify, merge, publish, distribute, and/or sell copies of the Software, and to permit persons to whom the Software is furnished to do so, provided that the above copyright notice(s) and this permission notice appear in all copies of the Software and that both the above copyright notice(s) and this permission notice appear in supporting documentation.

THE SOFTWARE IS PROVIDED "AS IS", WITHOUT WARRANTY OF ANY KIND, EXPRESS OR IMPLIED, INCLUDING BUT NOT LIMITED TO THE WARRANTIES OF MERCHANTABILITY, FITNESS FOR A PARTICULAR PURPOSE AND NONINFRINGEMENT OF THIRD PARTY RIGHTS. IN NO EVENT SHALL THE COPYRIGHT HOLDER OR HOLDERS INCLUDED IN THIS NOTICE BE LIABLE FOR ANY CLAIM, OR ANY SPECIAL INDIRECT OR CONSEQUENTIAL DAMAGES, OR ANY DAMAGES WHATSOEVER RESULTING FROM LOSS OF USE, DATA OR PROFITS, WHETHER IN AN ACTION OF CONTRACT, NEGLIGENCE OR OTHER TORTIOUS ACTION, ARISING OUT OF OR IN CONNECTION WITH THE USE OR PERFORMANCE OF THIS SOFTWARE.

Except as contained in this notice, the name of a copyright holder shall not be used in

advertising or otherwise to promote the sale, use or other dealings in this Software without prior written authorization of the copyright holder.

IJG

Independent JPEG Group License

LEGAL ISSUES

In plain English:

1. We don't promise that this software works. (But if you find any bugs, please let us know!)
2. You can use this software for whatever you want. You don't have to pay us.
3. You may not pretend that you wrote this software. If you use it in a program, you must acknowledge somewhere in your documentation that you've used the IJG code.

In legalese:

The authors make NO WARRANTY or representation, either express or implied, with respect to this software, its quality, accuracy, merchantability, or fitness for a particular purpose. This software is provided "AS IS", and you, its user, assume the entire risk as to its quality and accuracy.

This software is copyright (C) 1991-1998, Thomas G. Lane. All Rights Reserved except as specified below.

Permission is hereby granted to use, copy, modify, and distribute this software (or portions thereof) for any purpose, without fee, subject to these conditions:

- (1) If any part of the source code for this software is distributed, then this README file must be included, with this copyright and no-warranty notice unaltered; and any additions, deletions, or changes to the original files must be clearly indicated in accompanying documentation.
- (2) If only executable code is distributed, then the accompanying documentation must state that "this software is based in part on the work of the Independent JPEG Group".
- (3) Permission for use of this software is granted only if the user accepts full responsibility for any undesirable consequences; the authors accept NO LIABILITY for damages of any kind.

These conditions apply to any software derived from or based on the IJG code, not just to the unmodified library. If you use our work, you ought to acknowledge us.

Permission is NOT granted for the use of any IJG author's name or company name in advertising or publicity relating to this software or products derived from it. This software may be referred to only as "the Independent JPEG Group's software".

We specifically permit and encourage the use of this software as the basis of commercial products, provided that all warranty or liability claims are assumed by the product vendor.

ansi2knr.c is included in this distribution by permission of L. Peter Deutsch, sole proprietor of its copyright holder, Aladdin Enterprises of Menlo Park, CA. ansi2knr.c is NOT covered by the above copyright and conditions, but instead by the usual distribution terms of the Free Software Foundation; principally, that you must include source code if you redistribute it. (See the file ansi2knr.c for full details.) However, since ansi2knr.c is not needed as part of any program generated from the IJG code, this does not limit you more than the foregoing paragraphs do.

The Unix configuration script "configure" was produced with GNU Autoconf. It is copyright by the Free Software Foundation but is freely distributable. The same holds for its supporting scripts (config.guess, config.sub, ltconfig, ltmain.sh). Another support script, install-sh, is copyright by M.I.T. but is also freely distributable.

It appears that the arithmetic coding option of the JPEG spec is covered by patents owned by IBM, AT&T, and Mitsubishi. Hence arithmetic coding cannot legally be used without obtaining one or more licenses. For this reason, support for arithmetic coding has been removed from the free JPEG software. (Since arithmetic coding provides only a marginal gain over the unpatented Huffman mode, it is unlikely that very many implementations will support it.) So far as we are aware, there are no patent restrictions on the remaining code.

The IJG distribution formerly included code to read and write GIF files. To avoid entanglement with the Unisys LZW patent, GIF reading support has been removed altogether, and the GIF writer has been simplified to produce "uncompressed GIFs". This technique does not use the LZW algorithm; the resulting GIF files are larger than usual, but are readable by all standard GIF decoders.

We are required to state that

"The Graphics Interchange Format(c) is the Copyright property of CompuServe Incorporated. GIF(sm) is a Service Mark property of CompuServe Incorporated."

ISC

Permission to use, copy, modify, and/or distribute this software for any purpose with or without fee is hereby granted, provided that the above copyright notice and this permission

notice appear in all copies.

THE SOFTWARE IS PROVIDED "AS IS" AND THE AUTHOR DISCLAIMS ALL WARRANTIES WITH REGARD TO THIS SOFTWARE INCLUDING ALL IMPLIED WARRANTIES OF MERCHANTABILITY AND FITNESS. IN NO EVENT SHALL THE AUTHOR BE LIABLE FOR ANY SPECIAL, DIRECT, INDIRECT, OR CONSEQUENTIAL DAMAGES OR ANY DAMAGES WHATSOEVER RESULTING FROM LOSS OF USE, DATA OR PROFITS, WHETHER IN AN ACTION OF CONTRACT, NEGLIGENCE OR OTHER TORTIOUS ACTION, ARISING OUT OF OR IN CONNECTION WITH THE USE OR PERFORMANCE OF THIS SOFTWARE.

Info-ZIP

Info-ZIP License

Copyright (c) 1990-2009 Info-ZIP. All rights reserved.

For the purposes of this copyright and license, "Info-ZIP" is defined as the following set of individuals:

Mark Adler, John Bush, Karl Davis, Harald Denker, Jean-Michel Dubois, Jean-loup Gailly, Hunter Goatley, Ed Gordon, Ian Gorman, Chris Herborth, Dirk Haase, Greg Hartwig, Robert Heath, Jonathan Hudson, Paul Kienitz, David Kirschbaum, Johnny Lee, Onno van der Linden, Igor Mandrichenko, Steve P. Miller, Sergio Monesi, Keith Owens, George Petrov, Greg Roelofs, Kai Uwe Rommel, Steve Salisbury, Dave Smith, Steven M. Schweda, Christian Spieler, Cosmin Truta, Antoine Verheijen, Paul von Behren, Rich Wales, Mike White.

This software is provided "as is," without warranty of any kind, express or implied. In no event shall Info-ZIP or its contributors be held liable for any direct, indirect, incidental, special or consequential damages arising out of the use of or inability to use this software.

Permission is granted to anyone to use this software for any purpose, including commercial applications, and to alter it and redistribute it freely, subject to the above disclaimer and the following restrictions:

* Redistributions of source code (in whole or in part) must retain the above copyright notice, definition, disclaimer, and this list of conditions.

* Redistributions in binary form (compiled executables and libraries) must reproduce the above copyright notice, definition, disclaimer, and this list of conditions in documentation and/or other materials provided with the distribution. Additional documentation is not needed for executables where a command line license option provides these and a note regarding this option is in the executable's startup banner. The sole exception to this condition is



redistribution of a standard UnZipSFX binary (including SFXWiz) as part of a self-extracting archive; that is permitted without inclusion of this license, as long as the normal SFX banner has not been removed from the binary or disabled.

* Altered versions--including, but not limited to, ports to new operating systems, existing ports with new graphical interfaces, versions with modified or added functionality, and dynamic, shared, or static library versions not from Info-ZIP--must be plainly marked as such and must not be misrepresented as being the original source or, if binaries, compiled from the original source. Such altered versions also must not be misrepresented as being Info-ZIP releases--including, but not limited to, labeling of the altered versions with the names "Info-ZIP" (or any variation thereof, including, but not limited to, different capitalizations), "Pocket UnZip," "Wiz" or "MacZip" without the explicit permission of Info-ZIP. Such altered versions are further prohibited from misrepresentative use of the Zip-Bugs or Info-ZIP e-mail addresses or the Info-ZIP URL(s), such as to imply Info-ZIP will provide support for the altered versions.

* Info-ZIP retains the right to use the names "Info-ZIP," "Zip," "UnZip," "UnZipSFX," "Wiz," "Pocket UnZip," "Pocket Zip," and "MacZip" for its own source and binary releases.

LGPL-2.1

GNU LESSER GENERAL PUBLIC LICENSE

Version 2.1, February 1999

Copyright (C) 1991, 1999 Free Software Foundation, Inc.
51 Franklin Street, Fifth Floor, Boston, MA 02110-1301 USA

Everyone is permitted to copy and distribute verbatim copies of this license document, but changing it is not allowed.

[This is the first released version of the Lesser GPL. It also counts as the successor of the GNU Library Public License, version 2, hence the version number 2.1.]

Preamble

The licenses for most software are designed to take away your freedom to share and change it. By contrast, the GNU General Public Licenses are intended to guarantee your freedom to share and change free software--to make sure the software is free for all its users.

This license, the Lesser General Public License, applies to some specially designated software packages--typically libraries--of the Free Software Foundation and other authors who decide

to use it. You can use it too, but we suggest you first think carefully about whether this license or the ordinary General Public License is the better strategy to use in any particular case, based on the explanations below.

When we speak of free software, we are referring to freedom of use, not price. Our General Public Licenses are designed to make sure that you have the freedom to distribute copies of free software (and charge for this service if you wish); that you receive source code or can get it if you want it; that you can change the software and use pieces of it in new free programs; and that you are informed that you can do these things.

To protect your rights, we need to make restrictions that forbid distributors to deny you these rights or to ask you to surrender these rights. These restrictions translate to certain responsibilities for you if you distribute copies of the library or if you modify it.

For example, if you distribute copies of the library, whether gratis or for a fee, you must give the recipients all the rights that we gave you. You must make sure that they, too, receive or can get the source code. If you link other code with the library, you must provide complete object files to the recipients, so that they can relink them with the library after making changes to the library and recompiling it. And you must show them these terms so they know their rights.

We protect your rights with a two-step method: (1) we copyright the library, and (2) we offer you this license, which gives you legal permission to copy, distribute and/or modify the library.

To protect each distributor, we want to make it very clear that there is no warranty for the free library. Also, if the library is modified by someone else and passed on, the recipients should know that what they have is not the original version, so that the original author's reputation will not be affected by problems that might be introduced by others.

Finally, software patents pose a constant threat to the existence of any free program. We wish to make sure that a company cannot effectively restrict the users of a free program by obtaining a restrictive license from a patent holder. Therefore, we insist that any patent license obtained for a version of the library must be consistent with the full freedom of use specified in this license.

Most GNU software, including some libraries, is covered by the ordinary GNU General Public License. This license, the GNU Lesser General Public License, applies to certain designated libraries, and is quite different from the ordinary General Public License. We use this license for certain libraries in order to permit linking those libraries into non-free programs.

When a program is linked with a library, whether statically or using a shared library, the combination of the two is legally speaking a combined work, a derivative of the original library. The ordinary General Public License therefore permits such linking only if the entire



combination fits its criteria of freedom. The Lesser General Public License permits more lax criteria for linking other code with the library.

We call this license the "Lesser" General Public License because it does Less to protect the user's freedom than the ordinary General Public License. It also provides other free software developers Less of an advantage over competing non-free programs. These disadvantages are the reason we use the ordinary General Public License for many libraries. However, the Lesser license provides advantages in certain special circumstances.

For example, on rare occasions, there may be a special need to encourage the widest possible use of a certain library, so that it becomes a de-facto standard. To achieve this, non-free programs must be allowed to use the library. A more frequent case is that a free library does the same job as widely used non-free libraries. In this case, there is little to gain by limiting the free library to free software only, so we use the Lesser General Public License.

In other cases, permission to use a particular library in non-free programs enables a greater number of people to use a large body of free software. For example, permission to use the GNU C Library in non-free programs enables many more people to use the whole GNU operating system, as well as its variant, the GNU/Linux operating system.

Although the Lesser General Public License is Less protective of the users' freedom, it does ensure that the user of a program that is linked with the Library has the freedom and the wherewithal to run that program using a modified version of the Library.

The precise terms and conditions for copying, distribution and modification follow. Pay close attention to the difference between a "work based on the library" and a "work that uses the library". The former contains code derived from the library, whereas the latter must be combined with the library in order to run.

TERMS AND CONDITIONS FOR COPYING, DISTRIBUTION AND MODIFICATION

0. This License Agreement applies to any software library or other program which contains a notice placed by the copyright holder or other authorized party saying it may be distributed under the terms of this Lesser General Public License (also called "this License"). Each licensee is addressed as "you".

A "library" means a collection of software functions and/or data prepared so as to be conveniently linked with application programs (which use some of those functions and data) to form executables.

The "Library", below, refers to any such software library or work which has been distributed under these terms. A "work based on the Library" means either the Library or any derivative



work under copyright law: that is to say, a work containing the Library or a portion of it, either verbatim or with modifications and/or translated straightforwardly into another language. (Hereinafter, translation is included without limitation in the term "modification".)

"Source code" for a work means the preferred form of the work for making modifications to it. For a library, complete source code means all the source code for all modules it contains, plus any associated interface definition files, plus the scripts used to control compilation and installation of the library.

Activities other than copying, distribution and modification are not covered by this License; they are outside its scope. The act of running a program using the Library is not restricted, and output from such a program is covered only if its contents constitute a work based on the Library (independent of the use of the Library in a tool for writing it). Whether that is true depends on what the Library does and what the program that uses the Library does.

1. You may copy and distribute verbatim copies of the Library's complete source code as you receive it, in any medium, provided that you conspicuously and appropriately publish on each copy an appropriate copyright notice and disclaimer of warranty; keep intact all the notices that refer to this License and to the absence of any warranty; and distribute a copy of this License along with the Library.

You may charge a fee for the physical act of transferring a copy, and you may at your option offer warranty protection in exchange for a fee.

2. You may modify your copy or copies of the Library or any portion of it, thus forming a work based on the Library, and copy and distribute such modifications or work under the terms of Section 1 above, provided that you also meet all of these conditions:

- a) The modified work must itself be a software library.
- b) You must cause the files modified to carry prominent notices stating that you changed the files and the date of any change.
- c) You must cause the whole of the work to be licensed at no charge to all third parties under the terms of this License.
- d) If a facility in the modified Library refers to a function or a table of data to be supplied by an application program that uses the facility, other than as an argument passed when the facility is invoked, then you must make a good faith effort to ensure that, in the event an application does not supply such function or table, the facility still operates, and performs whatever part of its purpose remains meaningful.

(For example, a function in a library to compute square roots has a purpose that is entirely well-defined independent of the application. Therefore, Subsection 2d requires that any application-supplied function or table used by this function must be optional: if the application does not supply it, the square root function must still compute square roots.)

These requirements apply to the modified work as a whole. If identifiable sections of that work are not derived from the Library, and can be reasonably considered independent and separate works in themselves, then this License, and its terms, do not apply to those sections when you distribute them as separate works. But when you distribute the same sections as part of a whole which is a work based on the Library, the distribution of the whole must be on the terms of this License, whose permissions for other licensees extend to the entire whole, and thus to each and every part regardless of who wrote it.

Thus, it is not the intent of this section to claim rights or contest your rights to work written entirely by you; rather, the intent is to exercise the right to control the distribution of derivative or collective works based on the Library.

In addition, mere aggregation of another work not based on the Library with the Library (or with a work based on the Library) on a volume of a storage or distribution medium does not bring the other work under the scope of this License.

3. You may opt to apply the terms of the ordinary GNU General Public License instead of this License to a given copy of the Library. To do this, you must alter all the notices that refer to this License, so that they refer to the ordinary GNU General Public License, version 2, instead of to this License. (If a newer version than version 2 of the ordinary GNU General Public License has appeared, then you can specify that version instead if you wish.) Do not make any other change in these notices.

Once this change is made in a given copy, it is irreversible for that copy, so the ordinary GNU General Public License applies to all subsequent copies and derivative works made from that copy.

This option is useful when you wish to copy part of the code of the Library into a program that is not a library.

4. You may copy and distribute the Library (or a portion or derivative of it, under Section 2) in object code or executable form under the terms of Sections 1 and 2 above provided that you accompany it with the complete corresponding machine-readable source code, which must be distributed under the terms of Sections 1 and 2 above on a medium customarily used for software interchange.

If distribution of object code is made by offering access to copy from a designated place, then offering equivalent access to copy the source code from the same place satisfies the

requirement to distribute the source code, even though third parties are not compelled to copy the source along with the object code.

5. A program that contains no derivative of any portion of the Library, but is designed to work with the Library by being compiled or linked with it, is called a "work that uses the Library". Such a work, in isolation, is not a derivative work of the Library, and therefore falls outside the scope of this License.

However, linking a "work that uses the Library" with the Library creates an executable that is a derivative of the Library (because it contains portions of the Library), rather than a "work that uses the library". The executable is therefore covered by this License. Section 6 states terms for distribution of such executables.

When a "work that uses the Library" uses material from a header file that is part of the Library, the object code for the work may be a derivative work of the Library even though the source code is not. Whether this is true is especially significant if the work can be linked without the Library, or if the work is itself a library. The threshold for this to be true is not precisely defined by law.

If such an object file uses only numerical parameters, data structure layouts and accessors, and small macros and small inline functions (ten lines or less in length), then the use of the object file is unrestricted, regardless of whether it is legally a derivative work. (Executables containing this object code plus portions of the Library will still fall under Section 6.)

Otherwise, if the work is a derivative of the Library, you may distribute the object code for the work under the terms of Section 6. Any executables containing that work also fall under Section 6, whether or not they are linked directly with the Library itself.

6. As an exception to the Sections above, you may also combine or link a "work that uses the Library" with the Library to produce a work containing portions of the Library, and distribute that work under terms of your choice, provided that the terms permit modification of the work for the customer's own use and reverse engineering for debugging such modifications.

You must give prominent notice with each copy of the work that the Library is used in it and that the Library and its use are covered by this License. You must supply a copy of this License. If the work during execution displays copyright notices, you must include the copyright notice for the Library among them, as well as a reference directing the user to the copy of this License. Also, you must do one of these things:

a) Accompany the work with the complete corresponding machine-readable source code for the Library including whatever changes were used in the work (which must be distributed under Sections 1 and 2 above); and, if the work is an executable linked with the Library, with the complete machine-readable "work that uses the Library", as object code and/or source

code, so that the user can modify the Library and then relink to produce a modified executable containing the modified Library. (It is understood that the user who changes the contents of definitions files in the Library will not necessarily be able to recompile the application to use the modified definitions.)

b) Use a suitable shared library mechanism for linking with the Library. A suitable mechanism is one that (1) uses at run time a copy of the library already present on the user's computer system, rather than copying library functions into the executable, and (2) will operate properly with a modified version of the library, if the user installs one, as long as the modified version is interface-compatible with the version that the work was made with.

c) Accompany the work with a written offer, valid for at least three years, to give the same user the materials specified in Subsection 6a, above, for a charge no more than the cost of performing this distribution.

d) If distribution of the work is made by offering access to copy from a designated place, offer equivalent access to copy the above specified materials from the same place.

e) Verify that the user has already received a copy of these materials or that you have already sent this user a copy.

For an executable, the required form of the "work that uses the Library" must include any data and utility programs needed for reproducing the executable from it. However, as a special exception, the materials to be distributed need not include anything that is normally distributed (in either source or binary form) with the major components (compiler, kernel, and so on) of the operating system on which the executable runs, unless that component itself accompanies the executable.

It may happen that this requirement contradicts the license restrictions of other proprietary libraries that do not normally accompany the operating system. Such a contradiction means you cannot use both them and the Library together in an executable that you distribute.

7. You may place library facilities that are a work based on the Library side-by-side in a single library together with other library facilities not covered by this License, and distribute such a combined library, provided that the separate distribution of the work based on the Library and of the other library facilities is otherwise permitted, and provided that you do these two things:

a) Accompany the combined library with a copy of the same work based on the Library, uncombined with any other library facilities. This must be distributed under the terms of the Sections above.

b) Give prominent notice with the combined library of the fact that part of it is a work based

on the Library, and explaining where to find the accompanying uncombined form of the same work.

8. You may not copy, modify, sublicense, link with, or distribute the Library except as expressly provided under this License. Any attempt otherwise to copy, modify, sublicense, link with, or distribute the Library is void, and will automatically terminate your rights under this License. However, parties who have received copies, or rights, from you under this License will not have their licenses terminated so long as such parties remain in full compliance.

9. You are not required to accept this License, since you have not signed it. However, nothing else grants you permission to modify or distribute the Library or its derivative works. These actions are prohibited by law if you do not accept this License. Therefore, by modifying or distributing the Library (or any work based on the Library), you indicate your acceptance of this License to do so, and all its terms and conditions for copying, distributing or modifying the Library or works based on it.

10. Each time you redistribute the Library (or any work based on the Library), the recipient automatically receives a license from the original licensor to copy, distribute, link with or modify the Library subject to these terms and conditions. You may not impose any further restrictions on the recipients' exercise of the rights granted herein. You are not responsible for enforcing compliance by third parties with this License.

11. If, as a consequence of a court judgment or allegation of patent infringement or for any other reason (not limited to patent issues), conditions are imposed on you (whether by court order, agreement or otherwise) that contradict the conditions of this License, they do not excuse you from the conditions of this License. If you cannot distribute so as to satisfy simultaneously your obligations under this License and any other pertinent obligations, then as a consequence you may not distribute the Library at all. For example, if a patent license would not permit royalty-free redistribution of the Library by all those who receive copies directly or indirectly through you, then the only way you could satisfy both it and this License would be to refrain entirely from distribution of the Library.

If any portion of this section is held invalid or unenforceable under any particular circumstance, the balance of the section is intended to apply, and the section as a whole is intended to apply in other circumstances.

It is not the purpose of this section to induce you to infringe any patents or other property right claims or to contest validity of any such claims; this section has the sole purpose of protecting the integrity of the free software distribution system which is implemented by public license practices. Many people have made generous contributions to the wide range of software distributed through that system in reliance on consistent application of that system; it is up to the author/donor to decide if he or she is willing to distribute software through any other system and a licensee cannot impose that choice.



This section is intended to make thoroughly clear what is believed to be a consequence of the rest of this License.

12. If the distribution and/or use of the Library is restricted in certain countries either by patents or by copyrighted interfaces, the original copyright holder who places the Library under this License may add an explicit geographical distribution limitation excluding those countries, so that distribution is permitted only in or among countries not thus excluded. In such case, this License incorporates the limitation as if written in the body of this License.

13. The Free Software Foundation may publish revised and/or new versions of the Lesser General Public License from time to time. Such new versions will be similar in spirit to the present version, but may differ in detail to address new problems or concerns.

Each version is given a distinguishing version number. If the Library specifies a version number of this License which applies to it and "any later version", you have the option of following the terms and conditions either of that version or of any later version published by the Free Software Foundation. If the Library does not specify a license version number, you may choose any version ever published by the Free Software Foundation.

14. If you wish to incorporate parts of the Library into other free programs whose distribution conditions are incompatible with these, write to the author to ask for permission. For software which is copyrighted by the Free Software Foundation, write to the Free Software Foundation; we sometimes make exceptions for this. Our decision will be guided by the two goals of preserving the free status of all derivatives of our free software and of promoting the sharing and reuse of software generally.

NO WARRANTY

15. BECAUSE THE LIBRARY IS LICENSED FREE OF CHARGE, THERE IS NO WARRANTY FOR THE LIBRARY, TO THE EXTENT PERMITTED BY APPLICABLE LAW. EXCEPT WHEN OTHERWISE STATED IN WRITING THE COPYRIGHT HOLDERS AND/OR OTHER PARTIES PROVIDE THE LIBRARY "AS IS" WITHOUT WARRANTY OF ANY KIND, EITHER EXPRESSED OR IMPLIED, INCLUDING, BUT NOT LIMITED TO, THE IMPLIED WARRANTIES OF MERCHANTABILITY AND FITNESS FOR A PARTICULAR PURPOSE. THE ENTIRE RISK AS TO THE QUALITY AND PERFORMANCE OF THE LIBRARY IS WITH YOU. SHOULD THE LIBRARY PROVE DEFECTIVE, YOU ASSUME THE COST OF ALL NECESSARY SERVICING, REPAIR OR CORRECTION.

16. IN NO EVENT UNLESS REQUIRED BY APPLICABLE LAW OR AGREED TO IN WRITING WILL ANY COPYRIGHT HOLDER, OR ANY OTHER PARTY WHO MAY MODIFY AND/OR REDISTRIBUTE THE LIBRARY AS PERMITTED ABOVE, BE LIABLE TO YOU FOR DAMAGES, INCLUDING ANY GENERAL, SPECIAL, INCIDENTAL OR CONSEQUENTIAL DAMAGES ARISING OUT OF THE USE OR INABILITY TO USE THE LIBRARY (INCLUDING BUT NOT LIMITED TO LOSS OF DATA OR DATA BEING RENDERED INACCURATE OR LOSSES SUSTAINED BY YOU OR THIRD PARTIES



OR A FAILURE OF THE LIBRARY TO OPERATE WITH ANY OTHER SOFTWARE), EVEN IF SUCH HOLDER OR OTHER PARTY HAS BEEN ADVISED OF THE POSSIBILITY OF SUCH DAMAGES.

END OF TERMS AND CONDITIONS

How to Apply These Terms to Your New Libraries

If you develop a new library, and you want it to be of the greatest possible use to the public, we recommend making it free software that everyone can redistribute and change. You can do so by permitting redistribution under these terms (or, alternatively, under the terms of the ordinary General Public License).

To apply these terms, attach the following notices to the library. It is safest to attach them to the start of each source file to most effectively convey the exclusion of warranty; and each file should have at least the "copyright" line and a pointer to where the full notice is found.

one line to give the library's name and an idea of what it does.

Copyright (C) year name of author

This library is free software; you can redistribute it and/or modify it under the terms of the GNU Lesser General Public License as published by the Free Software Foundation; either version 2.1 of the License, or (at your option) any later version.

This library is distributed in the hope that it will be useful, but WITHOUT ANY WARRANTY; without even the implied warranty of MERCHANTABILITY or FITNESS FOR A PARTICULAR PURPOSE. See the GNU Lesser General Public License for more details.

You should have received a copy of the GNU Lesser General Public License along with this library; if not, write to the Free Software Foundation, Inc., 51 Franklin Street, Fifth Floor, Boston, MA 02110-1301 USA Also add information on how to contact you by electronic and paper mail.

You should also get your employer (if you work as a programmer) or your school, if any, to sign a "copyright disclaimer" for the library, if necessary. Here is a sample; alter the names:

Yoyodyne, Inc., hereby disclaims all copyright interest in
the library `Frob' (a library for tweaking knobs) written
by James Random Hacker.

signature of Ty Coon, 1 April 1990

Ty Coon, President of Vice
That's all there is to it!

Less

Copyright (C) 1984-2005 Mark Nudelman

Redistribution and use in source and binary forms, with or without modification, are permitted provided that the following conditions are met:

1. Redistributions of source code must retain the above copyright notice, this list of conditions and the following disclaimer.
2. Redistributions in binary form must reproduce the above copyright notice in the documentation and/or other materials provided with the distribution.

THIS SOFTWARE IS PROVIDED BY THE AUTHOR ``AS IS'' AND ANY EXPRESS OR IMPLIED WARRANTIES, INCLUDING, BUT NOT LIMITED TO, THE IMPLIED WARRANTIES OF MERCHANTABILITY AND FITNESS FOR A PARTICULAR PURPOSE ARE DISCLAIMED. IN NO EVENT SHALL THE AUTHOR BE LIABLE FOR ANY DIRECT, INDIRECT, INCIDENTAL, SPECIAL, EXEMPLARY, OR CONSEQUENTIAL DAMAGES (INCLUDING, BUT NOT LIMITED TO, PROCUREMENT OF SUBSTITUTE GOODS OR SERVICES; LOSS OF USE, DATA, OR PROFITS; OR BUSINESS INTERRUPTION) HOWEVER CAUSED AND ON ANY THEORY OF LIABILITY, WHETHER IN CONTRACT, STRICT LIABILITY, OR TORT (INCLUDING NEGLIGENCE OR OTHERWISE) ARISING IN ANY WAY OUT OF THE USE OF THIS SOFTWARE, EVEN IF ADVISED OF THE POSSIBILITY OF SUCH DAMAGE.

Libpng

This copy of the libpng notices is provided for your convenience. In case of any discrepancy between this copy and the notices in the file png.h that is included in the libpng distribution, the latter shall prevail.

COPYRIGHT NOTICE, DISCLAIMER, and LICENSE:

If you modify libpng you may insert additional notices immediately following this sentence.

This code is released under the libpng license.

libpng versions 1.2.6, August 15, 2004, through 1.4.5, December 9, 2010, are Copyright (c) 2004, 2006-2010 Glenn Randers-Pehrson, and are distributed according to the same disclaimer and license as libpng-1.2.5 with the following individual added to the list of Contributing Authors

Cosmin Truta

libpng versions 1.0.7, July 1, 2000, through 1.2.5 - October 3, 2002, are Copyright (c) 2000-2002 Glenn Randers-Pehrson, and are distributed according to the same disclaimer and license as libpng-1.0.6 with the following individuals added to the list of Contributing Authors

Simon-Pierre Cadieux

Eric S. Raymond

Gilles Vollant

and with the following additions to the disclaimer:

There is no warranty against interference with your enjoyment of the library or against infringement. There is no warranty that our efforts or the library will fulfill any of your particular purposes or needs. This library is provided with all faults, and the entire risk of satisfactory quality, performance, accuracy, and effort is with the user.

libpng versions 0.97, January 1998, through 1.0.6, March 20, 2000, are Copyright (c) 1998, 1999 Glenn Randers-Pehrson, and are distributed according to the same disclaimer and license as libpng-0.96, with the following individuals added to the list of Contributing Authors:

Tom Lane

Glenn Randers-Pehrson

Willem van Schaik

libpng versions 0.89, June 1996, through 0.96, May 1997, are Copyright (c) 1996, 1997 Andreas Digger

Distributed according to the same disclaimer and license as libpng-0.88, with the following individuals added to the list of Contributing Authors:



John Bowler
Kevin Bracey
Sam Bushell
Magnus Holmgren
Greg Roelofs
Tom Tanner

libpng versions 0.5, May 1995, through 0.88, January 1996, are
Copyright (c) 1995, 1996 Guy Eric Schalnat, Group 42, Inc.

For the purposes of this copyright and license, "Contributing Authors" is defined as the following set of individuals:

Andreas Dilger
Dave Martindale
Guy Eric Schalnat
Paul Schmidt
Tim Wegner

The PNG Reference Library is supplied "AS IS". The Contributing Authors and Group 42, Inc. disclaim all warranties, expressed or implied, including, without limitation, the warranties of merchantability and of fitness for any purpose. The Contributing Authors and Group 42, Inc. assume no liability for direct, indirect, incidental, special, exemplary, or consequential damages, which may result from the use of the PNG Reference Library, even if advised of the possibility of such damage.

Permission is hereby granted to use, copy, modify, and distribute this source code, or portions hereof, for any purpose, without fee, subject to the following restrictions:

1. The origin of this source code must not be misrepresented.
2. Altered versions must be plainly marked as such and must not be misrepresented as being the original source.
3. This Copyright notice may not be removed or altered from any source or altered source distribution.

The Contributing Authors and Group 42, Inc. specifically permit, without fee, and encourage the use of this source code as a component to supporting the PNG file format in commercial products. If you use this source code in a product, acknowledgment is not required but would

be appreciated.

A "png_get_copyright" function is available, for convenient use in "about" boxes and the like:

```
printf("%s",png_get_copyright(NULL));
```

Also, the PNG logo (in PNG format, of course) is supplied in the files "pngbar.png" and "pngbar.jpg (88x31) and "pngnow.png" (98x31).

Libpng is OSI Certified Open Source Software. OSI Certified Open Source is a certification mark of the Open Source Initiative.

Glenn Randers-Pehrson
glennrp at users.sourceforge.net
December 9, 2010

MIT

Permission is hereby granted, free of charge, to any person obtaining a copy of this software and associated documentation files (the "Software"), to deal in the Software without restriction, including without limitation the rights to use, copy, modify, merge, publish, distribute, sublicense, and/or sell copies of the Software, and to permit persons to whom the Software is furnished to do so, subject to the following conditions:

The above copyright notice and this permission notice shall be included in all copies or substantial portions of the Software.

THE SOFTWARE IS PROVIDED "AS IS", WITHOUT WARRANTY OF ANY KIND, EXPRESS OR IMPLIED, INCLUDING BUT NOT LIMITED TO THE WARRANTIES OF MERCHANTABILITY, FITNESS FOR A PARTICULAR PURPOSE AND NONINFRINGEMENT. IN NO EVENT SHALL THE AUTHORS OR COPYRIGHT HOLDERS BE LIABLE FOR ANY CLAIM, DAMAGES OR OTHER LIABILITY, WHETHER IN AN ACTION OF CONTRACT, TORT OR OTHERWISE, ARISING FROM, OUT OF OR IN CONNECTION WITH THE SOFTWARE OR THE USE OR OTHER DEALINGS IN THE SOFTWARE.

MIT-like License (HarfBuzz)

Permission is hereby granted, without written agreement and without license or royalty fees, to use, copy, modify, and distribute this

software and its documentation for any purpose, provided that the above copyright notice and the following two paragraphs appear in all copies of this software.

IN NO EVENT SHALL THE COPYRIGHT HOLDER BE LIABLE TO ANY PARTY FOR DIRECT, INDIRECT, SPECIAL, INCIDENTAL, OR CONSEQUENTIAL DAMAGES ARISING OUT OF THE USE OF THIS SOFTWARE AND ITS DOCUMENTATION, EVEN IF THE COPYRIGHT HOLDER HAS BEEN ADVISED OF THE POSSIBILITY OF SUCH DAMAGE.

THE COPYRIGHT HOLDER SPECIFICALLY DISCLAIMS ANY WARRANTIES, INCLUDING, BUT NOT LIMITED TO, THE IMPLIED WARRANTIES OF MERCHANTABILITY AND FITNESS FOR A PARTICULAR PURPOSE. THE SOFTWARE PROVIDED HEREUNDER IS ON AN "AS IS" BASIS, AND THE COPYRIGHT HOLDER HAS NO OBLIGATION TO PROVIDE MAINTENANCE, SUPPORT, UPDATES, ENHANCEMENTS, OR MODIFICATIONS.

MIT-like License (OSSP-uid)

Permission to use, copy, modify, and distribute this software for any purpose with or without fee is hereby granted, provided that the above copyright notice and this permission notice appear in all copies.

THIS SOFTWARE IS PROVIDED 'AS IS' AND ANY EXPRESSED OR IMPLIED WARRANTIES, INCLUDING, BUT NOT LIMITED TO, THE IMPLIED WARRANTIES OF MERCHANTABILITY AND FITNESS FOR A PARTICULAR PURPOSE ARE DISCLAIMED. IN NO EVENT SHALL THE AUTHORS AND COPYRIGHT HOLDERS AND THEIR CONTRIBUTORS BE LIABLE FOR ANY DIRECT, INDIRECT, INCIDENTAL, SPECIAL, EXEMPLARY, OR CONSEQUENTIAL DAMAGES (INCLUDING, BUT NOT LIMITED TO, PROCUREMENT OF SUBSTITUTE GOODS OR SERVICES; LOSS OF USE, DATA, OR PROFITS; OR BUSINESS INTERRUPTION) HOWEVER CAUSED AND ON ANY THEORY OF LIABILITY, WHETHER IN CONTRACT, STRICT LIABILITY, OR TORT (INCLUDING NEGLIGENCE OR OTHERWISE) ARISING IN ANY WAY OUT OF THE USE OF THIS SOFTWARE, EVEN IF ADVISED OF THE POSSIBILITY OF SUCH DAMAGE.

MIT-like License (OpenBSD)

Permission to use, copy, modify, and distribute this software for any purpose with or without fee is hereby granted, provided that the above copyright notice and this permission notice appear in all copies.

THE SOFTWARE IS PROVIDED "AS IS" AND THE AUTHOR DISCLAIMS ALL WARRANTIES WITH REGARD TO THIS SOFTWARE INCLUDING ALL IMPLIED WARRANTIES OF MERCHANTABILITY AND FITNESS. IN NO EVENT SHALL THE AUTHOR BE LIABLE FOR ANY SPECIAL, DIRECT, INDIRECT, OR CONSEQUENTIAL DAMAGES OR ANY DAMAGES WHATSOEVER RESULTING FROM LOSS OF USE, DATA OR PROFITS, WHETHER IN AN ACTION OF CONTRACT, NEGLIGENCE OR OTHER TORTIOUS ACTION, ARISING OUT OF OR IN CONNECTION WITH THE USE OR PERFORMANCE OF THIS SOFTWARE.

MIT-like License (c-ares)

Permission to use, copy, modify, and distribute this software and its documentation for any purpose and without fee is hereby granted, provided that the above copyright notice appear in all copies and that both that copyright notice and this permission notice appear in supporting documentation, and that the name of M.I.T. not be used in advertising or publicity pertaining to distribution of the software without specific, written prior permission. M.I.T. makes no representations about the suitability of this software for any purpose. It is provided ""as is"" without express or implied warranty.

MIT-like License (e2fsprogs)

Copyright 1987, 1988 by MIT Student Information Processing Board

Permission to use, copy, modify, and distribute this software and its documentation for any purpose is hereby granted, provided that the names of M.I.T. and the M.I.T. S.I.P.B. not be used in advertising or publicity pertaining to distribution of the software without specific, written prior permission. M.I.T. and the M.I.T. S.I.P.B. make no representations about the suitability of this software for any purpose. It is provided "as is" without express or implied warranty.

This quote is just too good to not pass on:

"BTW, I would have rejected the name Story Server because its initials are SS, the name of the secret police in Nazi Germany, probably the most despised pair of letters in western culture." --- <http://scriptingnewsarchive.userland.com/1999/12/13>

Let no one say political correctness isn't dead....

MIT-like License (fontconfig)

Permission to use, copy, modify, distribute, and sell this software and its documentation for any purpose is hereby granted without fee, provided that the above copyright notice appear in all copies and that both that copyright notice and this permission notice appear in supporting documentation, and that the name of the author(s) not be used in advertising or publicity pertaining to distribution of the software without specific, written prior permission. The authors make no representations about the suitability of this software for any purpose. It is provided "as is" without express or implied warranty.

THE AUTHOR(S) DISCLAIMS ALL WARRANTIES WITH REGARD TO THIS SOFTWARE, INCLUDING ALL IMPLIED WARRANTIES OF MERCHANTABILITY AND FITNESS, IN NO EVENT SHALL THE AUTHOR(S) BE LIABLE FOR ANY SPECIAL, INDIRECT OR CONSEQUENTIAL DAMAGES OR ANY DAMAGES WHATSOEVER RESULTING FROM LOSS OF USE, DATA OR PROFITS, WHETHER IN AN ACTION OF CONTRACT, NEGLIGENCE OR OTHER TORTIOUS ACTION, ARISING OUT OF OR IN CONNECTION WITH THE USE OR PERFORMANCE OF THIS SOFTWARE.

MIT-like License (krb5)

Copyright (C) 1985-2017 by the Massachusetts Institute of Technology.

All rights reserved.

Redistribution and use in source and binary forms, with or without modification, are permitted provided that the following conditions are met:

- * Redistributions of source code must retain the above copyright notice, this list of conditions and the following disclaimer.
- * Redistributions in binary form must reproduce the above copyright notice, this list of conditions and the following disclaimer in the



documentation and/or other materials provided with the distribution.

THIS SOFTWARE IS PROVIDED BY THE COPYRIGHT HOLDERS AND CONTRIBUTORS "AS IS" AND ANY EXPRESS OR IMPLIED WARRANTIES, INCLUDING, BUT NOT LIMITED TO, THE IMPLIED WARRANTIES OF MERCHANTABILITY AND FITNESS FOR A PARTICULAR PURPOSE ARE DISCLAIMED. IN NO EVENT SHALL THE COPYRIGHT HOLDER OR CONTRIBUTORS BE LIABLE FOR ANY DIRECT, INDIRECT, INCIDENTAL, SPECIAL, EXEMPLARY, OR CONSEQUENTIAL DAMAGES (INCLUDING, BUT NOT LIMITED TO, PROCUREMENT OF SUBSTITUTE GOODS OR SERVICES; LOSS OF USE, DATA, OR PROFITS; OR BUSINESS INTERRUPTION) HOWEVER CAUSED AND ON ANY THEORY OF LIABILITY, WHETHER IN CONTRACT, STRICT LIABILITY, OR TORT (INCLUDING NEGLIGENCE OR OTHERWISE) ARISING IN ANY WAY OUT OF THE USE OF THIS SOFTWARE, EVEN IF ADVISED OF THE POSSIBILITY OF SUCH DAMAGE.

Downloading of this software may constitute an export of cryptographic software from the United States of America that is subject to the United States Export Administration Regulations (EAR), 15 CFR 730-774. Additional laws or regulations may apply. It is the responsibility of the person or entity contemplating export to comply with all applicable export laws and regulations, including obtaining any required license from the U.S. government.

The U.S. government prohibits export of encryption source code to certain countries and individuals, including, but not limited to, the countries of Cuba, Iran, North Korea, Sudan, Syria, and residents and nationals of those countries.

Documentation components of this software distribution are licensed under a Creative Commons Attribution-ShareAlike 3.0 Unported License. (<http://creativecommons.org/licenses/by-sa/3.0/>)

Individual source code files are copyright MIT, Cygnus Support, Novell, OpenVision Technologies, Oracle, Red Hat, Sun Microsystems, FundsXpress, and others.

Project Athena, Athena, Athena MUSE, Discuss, Hesiod, Kerberos, Moira, and Zephyr are trademarks of the Massachusetts Institute of Technology



(MIT). No commercial use of these trademarks may be made without prior written permission of MIT.

"Commercial use" means use of a name in a product or other for-profit manner. It does NOT prevent a commercial firm from referring to the MIT trademarks in order to convey information (although in doing so, recognition of their trademark status should be given).

=====

The following copyright and permission notice applies to the OpenVision Kerberos Administration system located in "kadmin/create", "kadmin/dbutil", "kadmin/passwd", "kadmin/server", "lib/kadm5", and portions of "lib/rpc":

Copyright, OpenVision Technologies, Inc., 1993-1996, All Rights Reserved

WARNING: Retrieving the OpenVision Kerberos Administration system source code, as described below, indicates your acceptance of the following terms. If you do not agree to the following terms, do not retrieve the OpenVision Kerberos administration system.

You may freely use and distribute the Source Code and Object Code compiled from it, with or without modification, but this Source Code is provided to you "AS IS" EXCLUSIVE OF ANY WARRANTY, INCLUDING, WITHOUT LIMITATION, ANY WARRANTIES OF MERCHANTABILITY OR FITNESS FOR A PARTICULAR PURPOSE, OR ANY OTHER WARRANTY, WHETHER EXPRESS OR IMPLIED. IN NO EVENT WILL OPENVISION HAVE ANY LIABILITY FOR ANY LOST PROFITS, LOSS OF DATA OR COSTS OF PROCUREMENT OF SUBSTITUTE GOODS OR SERVICES, OR FOR ANY SPECIAL, INDIRECT, OR CONSEQUENTIAL DAMAGES ARISING OUT OF THIS AGREEMENT, INCLUDING, WITHOUT LIMITATION, THOSE RESULTING FROM THE USE OF THE SOURCE CODE, OR THE FAILURE OF THE SOURCE CODE TO PERFORM, OR FOR ANY OTHER REASON.

OpenVision retains all copyrights in the donated Source Code.



OpenVision also retains copyright to derivative works of the Source Code, whether created by OpenVision or by a third party. The OpenVision copyright notice must be preserved if derivative works are made based on the donated Source Code.

OpenVision Technologies, Inc. has donated this Kerberos Administration system to MIT for inclusion in the standard Kerberos 5 distribution. This donation underscores our commitment to continuing Kerberos technology development and our gratitude for the valuable work which has been performed by MIT and the Kerberos community.

=====

Portions contributed by Matt Crawford "crawdad@fnal.gov" were work performed at Fermi National Accelerator Laboratory, which is operated by Universities Research Association, Inc., under contract DE-AC02-76CHO3000 with the U.S. Department of Energy.

=====

Portions of "src/lib/crypto" have the following copyright:

Copyright (C) 1998 by the FundsXpress, INC.

All rights reserved.

Export of this software from the United States of America may require a specific license from the United States Government. It is the responsibility of any person or organization contemplating export to obtain such a license before exporting.

WITHIN THAT CONSTRAINT, permission to use, copy, modify, and distribute this software and its documentation for any purpose and without fee is hereby granted, provided that the above copyright notice appear in all copies and that both that copyright notice and this permission notice appear in supporting documentation, and that



the name of FundsXpress, not be used in advertising or publicity pertaining to distribution of the software without specific, written prior permission. FundsXpress makes no representations about the suitability of this software for any purpose. It is provided "as is" without express or implied warranty.

THIS SOFTWARE IS PROVIDED "AS IS" AND WITHOUT ANY EXPRESS OR IMPLIED WARRANTIES, INCLUDING, WITHOUT LIMITATION, THE IMPLIED WARRANTIES OF MERCHANTABILITY AND FITNESS FOR A PARTICULAR PURPOSE.

=====

The implementation of the AES encryption algorithm in "src/lib/crypto/builtin/aes" has the following copyright:

Copyright (C) 2001, Dr Brian Gladman "brg@gladman.uk.net", Worcester, UK. All rights reserved.

LICENSE TERMS

The free distribution and use of this software in both source and binary form is allowed (with or without changes) provided that:

1. distributions of this source code include the above copyright notice, this list of conditions and the following disclaimer;
2. distributions in binary form include the above copyright notice, this list of conditions and the following disclaimer in the documentation and/or other associated materials;
3. the copyright holder's name is not used to endorse products built using this software without specific written permission.

DISCLAIMER

This software is provided 'as is' with no explicit or implied warranties in respect of any properties, including, but not limited



to, correctness and fitness for purpose.

=====

Portions contributed by Red Hat, including the pre-authentication plug-in framework and the NSS crypto implementation, contain the following copyright:

Copyright (C) 2006 Red Hat, Inc.
Portions copyright (C) 2006 Massachusetts Institute of Technology
All Rights Reserved.

Redistribution and use in source and binary forms, with or without modification, are permitted provided that the following conditions are met:

* Redistributions of source code must retain the above copyright notice, this list of conditions and the following disclaimer.

* Redistributions in binary form must reproduce the above copyright notice, this list of conditions and the following disclaimer in the documentation and/or other materials provided with the distribution.

* Neither the name of Red Hat, Inc., nor the names of its contributors may be used to endorse or promote products derived from this software without specific prior written permission.

THIS SOFTWARE IS PROVIDED BY THE COPYRIGHT HOLDERS AND CONTRIBUTORS "AS IS" AND ANY EXPRESS OR IMPLIED WARRANTIES, INCLUDING, BUT NOT LIMITED TO, THE IMPLIED WARRANTIES OF MERCHANTABILITY AND FITNESS FOR A PARTICULAR PURPOSE ARE DISCLAIMED. IN NO EVENT SHALL THE COPYRIGHT OWNER OR CONTRIBUTORS BE LIABLE FOR ANY DIRECT, INDIRECT, INCIDENTAL, SPECIAL, EXEMPLARY, OR CONSEQUENTIAL DAMAGES (INCLUDING, BUT NOT LIMITED TO, PROCUREMENT OF SUBSTITUTE GOODS OR SERVICES; LOSS OF USE, DATA, OR PROFITS; OR BUSINESS INTERRUPTION) HOWEVER CAUSED AND ON ANY THEORY OF LIABILITY, WHETHER IN CONTRACT,



STRICT LIABILITY, OR TORT (INCLUDING NEGLIGENCE OR OTHERWISE)
ARISING IN ANY WAY OUT OF THE USE OF THIS SOFTWARE, EVEN IF ADVISED
OF THE POSSIBILITY OF SUCH DAMAGE.

=====

The bundled verto source code is subject to the following license:

Copyright 2011 Red Hat, Inc.

Permission is hereby granted, free of charge, to any person
obtaining a copy of this software and associated documentation
files (the "Software"), to deal in the Software without
restriction, including without limitation the rights to use, copy,
modify, merge, publish, distribute, sublicense, and/or sell copies
of the Software, and to permit persons to whom the Software is
furnished to do so, subject to the following conditions:

The above copyright notice and this permission notice shall be
included in all copies or substantial portions of the Software.

THE SOFTWARE IS PROVIDED "AS IS", WITHOUT WARRANTY OF ANY KIND,
EXPRESS OR IMPLIED, INCLUDING BUT NOT LIMITED TO THE WARRANTIES OF
MERCHANTABILITY, FITNESS FOR A PARTICULAR PURPOSE AND
NONINFRINGEMENT. IN NO EVENT SHALL THE AUTHORS OR COPYRIGHT
HOLDERS BE LIABLE FOR ANY CLAIM, DAMAGES OR OTHER LIABILITY,
WHETHER IN AN ACTION OF CONTRACT, TORT OR OTHERWISE, ARISING FROM,
OUT OF OR IN CONNECTION WITH THE SOFTWARE OR THE USE OR OTHER
DEALINGS IN THE SOFTWARE.

=====

The MS-KKDCP client implementation has the following copyright:

Copyright 2013,2014 Red Hat, Inc.

Redistribution and use in source and binary forms, with or without



modification, are permitted provided that the following conditions are met:

1. Redistributions of source code must retain the above copyright notice, this list of conditions and the following disclaimer.
2. Redistributions in binary form must reproduce the above copyright notice, this list of conditions and the following disclaimer in the documentation and/or other materials provided with the distribution.

THIS SOFTWARE IS PROVIDED BY THE COPYRIGHT HOLDERS AND CONTRIBUTORS "AS IS" AND ANY EXPRESS OR IMPLIED WARRANTIES, INCLUDING, BUT NOT LIMITED TO, THE IMPLIED WARRANTIES OF MERCHANTABILITY AND FITNESS FOR A PARTICULAR PURPOSE ARE DISCLAIMED. IN NO EVENT SHALL THE COPYRIGHT OWNER OR CONTRIBUTORS BE LIABLE FOR ANY DIRECT, INDIRECT, INCIDENTAL, SPECIAL, EXEMPLARY, OR CONSEQUENTIAL DAMAGES (INCLUDING, BUT NOT LIMITED TO, PROCUREMENT OF SUBSTITUTE GOODS OR SERVICES; LOSS OF USE, DATA, OR PROFITS; OR BUSINESS INTERRUPTION) HOWEVER CAUSED AND ON ANY THEORY OF LIABILITY, WHETHER IN CONTRACT, STRICT LIABILITY, OR TORT (INCLUDING NEGLIGENCE OR OTHERWISE) ARISING IN ANY WAY OUT OF THE USE OF THIS SOFTWARE, EVEN IF ADVISED OF THE POSSIBILITY OF SUCH DAMAGE.

=====
The implementations of GSSAPI mechglue in GSSAPI-SPNEGO in "src/lib/gssapi", including the following files:

```
lib/gssapi/generic/gssapi_err_generic.et  
lib/gssapi/mechglue/g_accept_sec_context.c  
lib/gssapi/mechglue/g_acquire_cred.c  
lib/gssapi/mechglue/g_canon_name.c  
lib/gssapi/mechglue/g_compare_name.c  
lib/gssapi/mechglue/g_context_time.c  
lib/gssapi/mechglue/g_delete_sec_context.c
```

lib/gssapi/mechglue/g_dsp_name.c
lib/gssapi/mechglue/g_dsp_status.c
lib/gssapi/mechglue/g_dup_name.c
lib/gssapi/mechglue/g_exp_sec_context.c
lib/gssapi/mechglue/g_export_name.c
lib/gssapi/mechglue/g_glue.c
lib/gssapi/mechglue/g_imp_name.c
lib/gssapi/mechglue/g_imp_sec_context.c
lib/gssapi/mechglue/g_init_sec_context.c
lib/gssapi/mechglue/g_initialize.c
lib/gssapi/mechglue/g_inquire_context.c
lib/gssapi/mechglue/g_inquire_cred.c
lib/gssapi/mechglue/g_inquire_names.c
lib/gssapi/mechglue/g_process_context.c
lib/gssapi/mechglue/g_rel_buffer.c
lib/gssapi/mechglue/g_rel_cred.c
lib/gssapi/mechglue/g_rel_name.c
lib/gssapi/mechglue/g_rel_oid_set.c
lib/gssapi/mechglue/g_seal.c
lib/gssapi/mechglue/g_sign.c
lib/gssapi/mechglue/g_store_cred.c
lib/gssapi/mechglue/g_unseal.c
lib/gssapi/mechglue/g_userok.c
lib/gssapi/mechglue/g_utils.c
lib/gssapi/mechglue/g_verify.c
lib/gssapi/mechglue/gssd_pname_to_uid.c
lib/gssapi/mechglue/mglueP.h
lib/gssapi/mechglue/oid_ops.c
lib/gssapi/spnego/gssapiP_spnego.h
lib/gssapi/spnego/spnego_mech.c

and the initial implementation of incremental propagation, including the following new or changed files:

include/iprop_hdr.h
kadmin/server/ipropd_svc.c
lib/kdb/iprop.x



lib/kdb/kdb_convert.c
lib/kdb/kdb_log.c
lib/kdb/kdb_log.h
lib/krb5/error_tables/kdb5_err.et
slave/kpropd_rpc.c
slave/kproplog.c

are subject to the following license:

Copyright (C) 2004 Sun Microsystems, Inc.

Permission is hereby granted, free of charge, to any person obtaining a copy of this software and associated documentation files (the "Software"), to deal in the Software without restriction, including without limitation the rights to use, copy, modify, merge, publish, distribute, sublicense, and/or sell copies of the Software, and to permit persons to whom the Software is furnished to do so, subject to the following conditions:

The above copyright notice and this permission notice shall be included in all copies or substantial portions of the Software.

THE SOFTWARE IS PROVIDED "AS IS", WITHOUT WARRANTY OF ANY KIND, EXPRESS OR IMPLIED, INCLUDING BUT NOT LIMITED TO THE WARRANTIES OF MERCHANTABILITY, FITNESS FOR A PARTICULAR PURPOSE AND NONINFRINGEMENT. IN NO EVENT SHALL THE AUTHORS OR COPYRIGHT HOLDERS BE LIABLE FOR ANY CLAIM, DAMAGES OR OTHER LIABILITY, WHETHER IN AN ACTION OF CONTRACT, TORT OR OTHERWISE, ARISING FROM, OUT OF OR IN CONNECTION WITH THE SOFTWARE OR THE USE OR OTHER DEALINGS IN THE SOFTWARE.

=====

Kerberos V5 includes documentation and software developed at the University of California at Berkeley, which includes this copyright notice:



Copyright (C) 1983 Regents of the University of California.
All rights reserved.

Redistribution and use in source and binary forms, with or without modification, are permitted provided that the following conditions are met:

1. Redistributions of source code must retain the above copyright notice, this list of conditions and the following disclaimer.
2. Redistributions in binary form must reproduce the above copyright notice, this list of conditions and the following disclaimer in the documentation and/or other materials provided with the distribution.
3. Neither the name of the University nor the names of its contributors may be used to endorse or promote products derived from this software without specific prior written permission.

THIS SOFTWARE IS PROVIDED BY THE REGENTS AND CONTRIBUTORS "AS IS" AND ANY EXPRESS OR IMPLIED WARRANTIES, INCLUDING, BUT NOT LIMITED TO, THE IMPLIED WARRANTIES OF MERCHANTABILITY AND FITNESS FOR A PARTICULAR PURPOSE ARE DISCLAIMED. IN NO EVENT SHALL THE REGENTS OR CONTRIBUTORS BE LIABLE FOR ANY DIRECT, INDIRECT, INCIDENTAL, SPECIAL, EXEMPLARY, OR CONSEQUENTIAL DAMAGES (INCLUDING, BUT NOT LIMITED TO, PROCUREMENT OF SUBSTITUTE GOODS OR SERVICES; LOSS OF USE, DATA, OR PROFITS; OR BUSINESS INTERRUPTION) HOWEVER CAUSED AND ON ANY THEORY OF LIABILITY, WHETHER IN CONTRACT, STRICT LIABILITY, OR TORT (INCLUDING NEGLIGENCE OR OTHERWISE) ARISING IN ANY WAY OUT OF THE USE OF THIS SOFTWARE, EVEN IF ADVISED OF THE POSSIBILITY OF SUCH DAMAGE.

=====

Portions contributed by Novell, Inc., including the LDAP database backend, are subject to the following license:



Copyright (C) 2004-2005, Novell, Inc.
All rights reserved.

Redistribution and use in source and binary forms, with or without modification, are permitted provided that the following conditions are met:

* Redistributions of source code must retain the above copyright notice, this list of conditions and the following disclaimer.

* Redistributions in binary form must reproduce the above copyright notice, this list of conditions and the following disclaimer in the documentation and/or other materials provided with the distribution.

* The copyright holder's name is not used to endorse or promote products derived from this software without specific prior written permission.

THIS SOFTWARE IS PROVIDED BY THE COPYRIGHT HOLDERS AND CONTRIBUTORS "AS IS" AND ANY EXPRESS OR IMPLIED WARRANTIES, INCLUDING, BUT NOT LIMITED TO, THE IMPLIED WARRANTIES OF MERCHANTABILITY AND FITNESS FOR A PARTICULAR PURPOSE ARE DISCLAIMED. IN NO EVENT SHALL THE COPYRIGHT OWNER OR CONTRIBUTORS BE LIABLE FOR ANY DIRECT, INDIRECT, INCIDENTAL, SPECIAL, EXEMPLARY, OR CONSEQUENTIAL DAMAGES (INCLUDING, BUT NOT LIMITED TO, PROCUREMENT OF SUBSTITUTE GOODS OR SERVICES; LOSS OF USE, DATA, OR PROFITS; OR BUSINESS INTERRUPTION) HOWEVER CAUSED AND ON ANY THEORY OF LIABILITY, WHETHER IN CONTRACT, STRICT LIABILITY, OR TORT (INCLUDING NEGLIGENCE OR OTHERWISE) ARISING IN ANY WAY OUT OF THE USE OF THIS SOFTWARE, EVEN IF ADVISED OF THE POSSIBILITY OF SUCH DAMAGE.

=====

Portions funded by Sandia National Laboratory and developed by the University of Michigan's Center for Information Technology Integration, including the PKINIT implementation, are subject to the



following license:

COPYRIGHT (C) 2006-2007
THE REGENTS OF THE UNIVERSITY OF MICHIGAN
ALL RIGHTS RESERVED

Permission is granted to use, copy, create derivative works and redistribute this software and such derivative works for any purpose, so long as the name of The University of Michigan is not used in any advertising or publicity pertaining to the use of distribution of this software without specific, written prior authorization. If the above copyright notice or any other identification of the University of Michigan is included in any copy of any portion of this software, then the disclaimer below must also be included.

THIS SOFTWARE IS PROVIDED AS IS, WITHOUT REPRESENTATION FROM THE UNIVERSITY OF MICHIGAN AS TO ITS FITNESS FOR ANY PURPOSE, AND WITHOUT WARRANTY BY THE UNIVERSITY OF MICHIGAN OF ANY KIND, EITHER EXPRESS OR IMPLIED, INCLUDING WITHOUT LIMITATION THE IMPLIED WARRANTIES OF MERCHANTABILITY AND FITNESS FOR A PARTICULAR PURPOSE. THE REGENTS OF THE UNIVERSITY OF MICHIGAN SHALL NOT BE LIABLE FOR ANY DAMAGES, INCLUDING SPECIAL, INDIRECT, INCIDENTAL, OR CONSEQUENTIAL DAMAGES, WITH RESPECT TO ANY CLAIM ARISING OUT OF OR IN CONNECTION WITH THE USE OF THE SOFTWARE, EVEN IF IT HAS BEEN OR IS HEREAFTER ADVISED OF THE POSSIBILITY OF SUCH DAMAGES.

=====

The pkcs11.h file included in the PKINIT code has the following license:

Copyright 2006 g10 Code GmbH
Copyright 2006 Andreas Jellinghaus

This file is free software; as a special exception the author gives unlimited permission to copy and/or distribute it, with or without



modifications, as long as this notice is preserved.

This file is distributed in the hope that it will be useful, but WITHOUT ANY WARRANTY, to the extent permitted by law; without even the implied warranty of MERCHANTABILITY or FITNESS FOR A PARTICULAR PURPOSE.

=====

Portions contributed by Apple Inc. are subject to the following license:

Copyright 2004-2008 Apple Inc. All Rights Reserved.

Export of this software from the United States of America may require a specific license from the United States Government. It is the responsibility of any person or organization contemplating export to obtain such a license before exporting.

WITHIN THAT CONSTRAINT, permission to use, copy, modify, and distribute this software and its documentation for any purpose and without fee is hereby granted, provided that the above copyright notice appear in all copies and that both that copyright notice and this permission notice appear in supporting documentation, and that the name of Apple Inc. not be used in advertising or publicity pertaining to distribution of the software without specific, written prior permission. Apple Inc. makes no representations about the suitability of this software for any purpose. It is provided "as is" without express or implied warranty.

THIS SOFTWARE IS PROVIDED "AS IS" AND WITHOUT ANY EXPRESS OR IMPLIED WARRANTIES, INCLUDING, WITHOUT LIMITATION, THE IMPLIED WARRANTIES OF MERCHANTABILITY AND FITNESS FOR A PARTICULAR PURPOSE.

=====

The implementations of UTF-8 string handling in src/util/support and

src/lib/krb5/unicode are subject to the following copyright and permission notice:

The OpenLDAP Public License
Version 2.8, 17 August 2003

Redistribution and use of this software and associated documentation ("Software"), with or without modification, are permitted provided that the following conditions are met:

1. Redistributions in source form must retain copyright statements and notices,
2. Redistributions in binary form must reproduce applicable copyright statements and notices, this list of conditions, and the following disclaimer in the documentation and/or other materials provided with the distribution, and
3. Redistributions must contain a verbatim copy of this document.

The OpenLDAP Foundation may revise this license from time to time. Each revision is distinguished by a version number. You may use this Software under terms of this license revision or under the terms of any subsequent revision of the license.

THIS SOFTWARE IS PROVIDED BY THE OPENLDAP FOUNDATION AND ITS CONTRIBUTORS "AS IS" AND ANY EXPRESSED OR IMPLIED WARRANTIES, INCLUDING, BUT NOT LIMITED TO, THE IMPLIED WARRANTIES OF MERCHANTABILITY AND FITNESS FOR A PARTICULAR PURPOSE ARE DISCLAIMED. IN NO EVENT SHALL THE OPENLDAP FOUNDATION, ITS CONTRIBUTORS, OR THE AUTHOR(S) OR OWNER(S) OF THE SOFTWARE BE LIABLE FOR ANY DIRECT, INDIRECT, INCIDENTAL, SPECIAL, EXEMPLARY, OR CONSEQUENTIAL DAMAGES (INCLUDING, BUT NOT LIMITED TO, PROCUREMENT OF SUBSTITUTE GOODS OR SERVICES; LOSS OF USE, DATA, OR PROFITS; OR BUSINESS INTERRUPTION) HOWEVER CAUSED AND ON ANY THEORY OF LIABILITY, WHETHER IN CONTRACT, STRICT LIABILITY, OR TORT (INCLUDING NEGLIGENCE OR OTHERWISE) ARISING IN ANY WAY OUT OF THE



USE OF THIS SOFTWARE, EVEN IF ADVISED OF THE POSSIBILITY OF SUCH DAMAGE.

The names of the authors and copyright holders must not be used in advertising or otherwise to promote the sale, use or other dealing in this Software without specific, written prior permission. Title to copyright in this Software shall at all times remain with copyright holders.

OpenLDAP is a registered trademark of the OpenLDAP Foundation.

Copyright 1999-2003 The OpenLDAP Foundation, Redwood City, California, USA. All Rights Reserved. Permission to copy and distribute verbatim copies of this document is granted.

=====

Marked test programs in src/lib/krb5/krb have the following copyright:

Copyright (C) 2006 Kungliga Tekniska Högskola
(Royal Institute of Technology, Stockholm, Sweden).
All rights reserved.

Redistribution and use in source and binary forms, with or without modification, are permitted provided that the following conditions are met:

1. Redistributions of source code must retain the above copyright notice, this list of conditions and the following disclaimer.
2. Redistributions in binary form must reproduce the above copyright notice, this list of conditions and the following disclaimer in the documentation and/or other materials provided with the distribution.
3. Neither the name of KTH nor the names of its contributors may be used to endorse or promote products derived from this software

without specific prior written permission.

THIS SOFTWARE IS PROVIDED BY KTH AND ITS CONTRIBUTORS "AS IS" AND ANY EXPRESS OR IMPLIED WARRANTIES, INCLUDING, BUT NOT LIMITED TO, THE IMPLIED WARRANTIES OF MERCHANTABILITY AND FITNESS FOR A PARTICULAR PURPOSE ARE DISCLAIMED. IN NO EVENT SHALL KTH OR ITS CONTRIBUTORS BE LIABLE FOR ANY DIRECT, INDIRECT, INCIDENTAL, SPECIAL, EXEMPLARY, OR CONSEQUENTIAL DAMAGES (INCLUDING, BUT NOT LIMITED TO, PROCUREMENT OF SUBSTITUTE GOODS OR SERVICES; LOSS OF USE, DATA, OR PROFITS; OR BUSINESS INTERRUPTION) HOWEVER CAUSED AND ON ANY THEORY OF LIABILITY, WHETHER IN CONTRACT, STRICT LIABILITY, OR TORT (INCLUDING NEGLIGENCE OR OTHERWISE) ARISING IN ANY WAY OUT OF THE USE OF THIS SOFTWARE, EVEN IF ADVISED OF THE POSSIBILITY OF SUCH DAMAGE.

=====

The KCM Mach RPC definition file used on OS X has the following copyright:

Copyright (C) 2009 Kungliga Tekniska Högskola
(Royal Institute of Technology, Stockholm, Sweden).
All rights reserved.

Portions Copyright (C) 2009 Apple Inc. All rights reserved.

Redistribution and use in source and binary forms, with or without modification, are permitted provided that the following conditions are met:

1. Redistributions of source code must retain the above copyright notice, this list of conditions and the following disclaimer.
2. Redistributions in binary form must reproduce the above copyright notice, this list of conditions and the following disclaimer in the documentation and/or other materials provided



with the distribution.

3. Neither the name of the Institute nor the names of its contributors may be used to endorse or promote products derived from this software without specific prior written permission.

THIS SOFTWARE IS PROVIDED BY THE INSTITUTE AND CONTRIBUTORS "AS IS" AND ANY EXPRESS OR IMPLIED WARRANTIES, INCLUDING, BUT NOT LIMITED TO, THE IMPLIED WARRANTIES OF MERCHANTABILITY AND FITNESS FOR A PARTICULAR PURPOSE ARE DISCLAIMED. IN NO EVENT SHALL THE INSTITUTE OR CONTRIBUTORS BE LIABLE FOR ANY DIRECT, INDIRECT, INCIDENTAL, SPECIAL, EXEMPLARY, OR CONSEQUENTIAL DAMAGES (INCLUDING, BUT NOT LIMITED TO, PROCUREMENT OF SUBSTITUTE GOODS OR SERVICES; LOSS OF USE, DATA, OR PROFITS; OR BUSINESS INTERRUPTION) HOWEVER CAUSED AND ON ANY THEORY OF LIABILITY, WHETHER IN CONTRACT, STRICT LIABILITY, OR TORT (INCLUDING NEGLIGENCE OR OTHERWISE) ARISING IN ANY WAY OUT OF THE USE OF THIS SOFTWARE, EVEN IF ADVISED OF THE POSSIBILITY OF SUCH DAMAGE.

=====

Portions of the RPC implementation in src/lib/rpc and src/include/gssrpc have the following copyright and permission notice:

Copyright (C) 2010, Oracle America, Inc.

All rights reserved.

Redistribution and use in source and binary forms, with or without modification, are permitted provided that the following conditions are met:

1. Redistributions of source code must retain the above copyright notice, this list of conditions and the following disclaimer.
2. Redistributions in binary form must reproduce the above copyright notice, this list of conditions and the following



disclaimer in the documentation and/or other materials provided with the distribution.

3. Neither the name of the "Oracle America, Inc." nor the names of its contributors may be used to endorse or promote products derived from this software without specific prior written permission.

THIS SOFTWARE IS PROVIDED BY THE COPYRIGHT HOLDERS AND CONTRIBUTORS "AS IS" AND ANY EXPRESS OR IMPLIED WARRANTIES, INCLUDING, BUT NOT LIMITED TO, THE IMPLIED WARRANTIES OF MERCHANTABILITY AND FITNESS FOR A PARTICULAR PURPOSE ARE DISCLAIMED. IN NO EVENT SHALL THE COPYRIGHT HOLDER OR CONTRIBUTORS BE LIABLE FOR ANY DIRECT, INDIRECT, INCIDENTAL, SPECIAL, EXEMPLARY, OR CONSEQUENTIAL DAMAGES (INCLUDING, BUT NOT LIMITED TO, PROCUREMENT OF SUBSTITUTE GOODS OR SERVICES; LOSS OF USE, DATA, OR PROFITS; OR BUSINESS INTERRUPTION) HOWEVER CAUSED AND ON ANY THEORY OF LIABILITY, WHETHER IN CONTRACT, STRICT LIABILITY, OR TORT (INCLUDING NEGLIGENCE OR OTHERWISE) ARISING IN ANY WAY OUT OF THE USE OF THIS SOFTWARE, EVEN IF ADVISED OF THE POSSIBILITY OF SUCH DAMAGE.

=====

Copyright (C) 2006,2007,2009 NTT (Nippon Telegraph and Telephone Corporation). All rights reserved.

Redistribution and use in source and binary forms, with or without modification, are permitted provided that the following conditions are met:

1. Redistributions of source code must retain the above copyright notice, this list of conditions and the following disclaimer as the first lines of this file unmodified.
2. Redistributions in binary form must reproduce the above copyright notice, this list of conditions and the following disclaimer in the documentation and/or other materials provided



with the distribution.

THIS SOFTWARE IS PROVIDED BY NTT "AS IS" AND ANY EXPRESS OR IMPLIED WARRANTIES, INCLUDING, BUT NOT LIMITED TO, THE IMPLIED WARRANTIES OF MERCHANTABILITY AND FITNESS FOR A PARTICULAR PURPOSE ARE DISCLAIMED. IN NO EVENT SHALL NTT BE LIABLE FOR ANY DIRECT, INDIRECT, INCIDENTAL, SPECIAL, EXEMPLARY, OR CONSEQUENTIAL DAMAGES (INCLUDING, BUT NOT LIMITED TO, PROCUREMENT OF SUBSTITUTE GOODS OR SERVICES; LOSS OF USE, DATA, OR PROFITS; OR BUSINESS INTERRUPTION) HOWEVER CAUSED AND ON ANY THEORY OF LIABILITY, WHETHER IN CONTRACT, STRICT LIABILITY, OR TORT (INCLUDING NEGLIGENCE OR OTHERWISE) ARISING IN ANY WAY OUT OF THE USE OF THIS SOFTWARE, EVEN IF ADVISED OF THE POSSIBILITY OF SUCH DAMAGE.

=====

Copyright 2000 by Carnegie Mellon University

All Rights Reserved

Permission to use, copy, modify, and distribute this software and its documentation for any purpose and without fee is hereby granted, provided that the above copyright notice appear in all copies and that both that copyright notice and this permission notice appear in supporting documentation, and that the name of Carnegie Mellon University not be used in advertising or publicity pertaining to distribution of the software without specific, written prior permission.

CARNEGIE MELLON UNIVERSITY DISCLAIMS ALL WARRANTIES WITH REGARD TO THIS SOFTWARE, INCLUDING ALL IMPLIED WARRANTIES OF MERCHANTABILITY AND FITNESS, IN NO EVENT SHALL CARNEGIE MELLON UNIVERSITY BE LIABLE FOR ANY SPECIAL, INDIRECT OR CONSEQUENTIAL DAMAGES OR ANY DAMAGES WHATSOEVER RESULTING FROM LOSS OF USE, DATA OR PROFITS, WHETHER IN AN ACTION OF CONTRACT, NEGLIGENCE OR OTHER TORTIOUS ACTION, ARISING OUT OF OR IN CONNECTION WITH THE USE OR PERFORMANCE OF THIS SOFTWARE.



=====

Copyright (C) 2002 Naval Research Laboratory (NRL/CCS)

Permission to use, copy, modify and distribute this software and its documentation is hereby granted, provided that both the copyright notice and this permission notice appear in all copies of the software, derivative works or modified versions, and any portions thereof.

NRL ALLOWS FREE USE OF THIS SOFTWARE IN ITS "AS IS" CONDITION AND DISCLAIMS ANY LIABILITY OF ANY KIND FOR ANY DAMAGES WHATSOEVER RESULTING FROM THE USE OF THIS SOFTWARE.

=====

Portions extracted from Internet RFCs have the following copyright notice:

Copyright (C) The Internet Society (2006).

This document is subject to the rights, licenses and restrictions contained in BCP 78, and except as set forth therein, the authors retain all their rights.

This document and the information contained herein are provided on an "AS IS" basis and THE CONTRIBUTOR, THE ORGANIZATION HE/SHE REPRESENTS OR IS SPONSORED BY (IF ANY), THE INTERNET SOCIETY AND THE INTERNET ENGINEERING TASK FORCE DISCLAIM ALL WARRANTIES, EXPRESS OR IMPLIED, INCLUDING BUT NOT LIMITED TO ANY WARRANTY THAT THE USE OF THE INFORMATION HEREIN WILL NOT INFRINGE ANY RIGHTS OR ANY IMPLIED WARRANTIES OF MERCHANTABILITY OR FITNESS FOR A PARTICULAR PURPOSE.

=====



Copyright (C) 1991, 1992, 1994 by Cygnus Support.

Permission to use, copy, modify, and distribute this software and its documentation for any purpose and without fee is hereby granted, provided that the above copyright notice appear in all copies and that both that copyright notice and this permission notice appear in supporting documentation. Cygnus Support makes no representations about the suitability of this software for any purpose. It is provided "as is" without express or implied warranty.

=====

Copyright (C) 2006 Secure Endpoints Inc.

Permission is hereby granted, free of charge, to any person obtaining a copy of this software and associated documentation files (the "Software"), to deal in the Software without restriction, including without limitation the rights to use, copy, modify, merge, publish, distribute, sublicense, and/or sell copies of the Software, and to permit persons to whom the Software is furnished to do so, subject to the following conditions:

The above copyright notice and this permission notice shall be included in all copies or substantial portions of the Software.

THE SOFTWARE IS PROVIDED "AS IS", WITHOUT WARRANTY OF ANY KIND, EXPRESS OR IMPLIED, INCLUDING BUT NOT LIMITED TO THE WARRANTIES OF MERCHANTABILITY, FITNESS FOR A PARTICULAR PURPOSE AND NONINFRINGEMENT. IN NO EVENT SHALL THE AUTHORS OR COPYRIGHT HOLDERS BE LIABLE FOR ANY CLAIM, DAMAGES OR OTHER LIABILITY, WHETHER IN AN ACTION OF CONTRACT, TORT OR OTHERWISE, ARISING FROM, OUT OF OR IN CONNECTION WITH THE SOFTWARE OR THE USE OR OTHER DEALINGS IN THE SOFTWARE.

Portions of the implementation of the Fortuna-like PRNG are subject to the following notice:

Copyright (C) 2005 Marko Kreen
All rights reserved.

Redistribution and use in source and binary forms, with or without modification, are permitted provided that the following conditions are met:

1. Redistributions of source code must retain the above copyright notice, this list of conditions and the following disclaimer.
2. Redistributions in binary form must reproduce the above copyright notice, this list of conditions and the following disclaimer in the documentation and/or other materials provided with the distribution.

THIS SOFTWARE IS PROVIDED BY THE AUTHOR AND CONTRIBUTORS "AS IS" AND ANY EXPRESS OR IMPLIED WARRANTIES, INCLUDING, BUT NOT LIMITED TO, THE IMPLIED WARRANTIES OF MERCHANTABILITY AND FITNESS FOR A PARTICULAR PURPOSE ARE DISCLAIMED. IN NO EVENT SHALL THE AUTHOR OR CONTRIBUTORS BE LIABLE FOR ANY DIRECT, INDIRECT, INCIDENTAL, SPECIAL, EXEMPLARY, OR CONSEQUENTIAL DAMAGES (INCLUDING, BUT NOT LIMITED TO, PROCUREMENT OF SUBSTITUTE GOODS OR SERVICES; LOSS OF USE, DATA, OR PROFITS; OR BUSINESS INTERRUPTION) HOWEVER CAUSED AND ON ANY THEORY OF LIABILITY, WHETHER IN CONTRACT, STRICT LIABILITY, OR TORT (INCLUDING NEGLIGENCE OR OTHERWISE) ARISING IN ANY WAY OUT OF THE USE OF THIS SOFTWARE, EVEN IF ADVISED OF THE POSSIBILITY OF SUCH DAMAGE.

Copyright (C) 1994 by the University of Southern California

EXPORT OF THIS SOFTWARE from the United States of America may require a specific license from the United States Government. It is the responsibility of any person or organization contemplating export to obtain such a license before exporting.



WITHIN THAT CONSTRAINT, permission to copy, modify, and distribute this software and its documentation in source and binary forms is hereby granted, provided that any documentation or other materials related to such distribution or use acknowledge that the software was developed by the University of Southern California.

DISCLAIMER OF WARRANTY. THIS SOFTWARE IS PROVIDED "AS IS". The University of Southern California MAKES NO REPRESENTATIONS OR WARRANTIES, EXPRESS OR IMPLIED. By way of example, but not limitation, the University of Southern California MAKES NO REPRESENTATIONS OR WARRANTIES OF MERCHANTABILITY OR FITNESS FOR ANY PARTICULAR PURPOSE. The University of Southern California shall not be held liable for any liability nor for any direct, indirect, or consequential damages with respect to any claim by the user or distributor of the ksu software.

=====

Copyright (C) 1995
The President and Fellows of Harvard University

This code is derived from software contributed to Harvard by Jeremy Rassen.

Redistribution and use in source and binary forms, with or without modification, are permitted provided that the following conditions are met:

1. Redistributions of source code must retain the above copyright notice, this list of conditions and the following disclaimer.
2. Redistributions in binary form must reproduce the above copyright notice, this list of conditions and the following disclaimer in the documentation and/or other materials provided with the distribution.



3. All advertising materials mentioning features or use of this software must display the following acknowledgement:

This product includes software developed by the University of California, Berkeley and its contributors.

4. Neither the name of the University nor the names of its contributors may be used to endorse or promote products derived from this software without specific prior written permission.

THIS SOFTWARE IS PROVIDED BY THE REGENTS AND CONTRIBUTORS "AS IS" AND ANY EXPRESS OR IMPLIED WARRANTIES, INCLUDING, BUT NOT LIMITED TO, THE IMPLIED WARRANTIES OF MERCHANTABILITY AND FITNESS FOR A PARTICULAR PURPOSE ARE DISCLAIMED. IN NO EVENT SHALL THE REGENTS OR CONTRIBUTORS BE LIABLE FOR ANY DIRECT, INDIRECT, INCIDENTAL, SPECIAL, EXEMPLARY, OR CONSEQUENTIAL DAMAGES (INCLUDING, BUT NOT LIMITED TO, PROCUREMENT OF SUBSTITUTE GOODS OR SERVICES; LOSS OF USE, DATA, OR PROFITS; OR BUSINESS INTERRUPTION) HOWEVER CAUSED AND ON ANY THEORY OF LIABILITY, WHETHER IN CONTRACT, STRICT LIABILITY, OR TORT (INCLUDING NEGLIGENCE OR OTHERWISE) ARISING IN ANY WAY OUT OF THE USE OF THIS SOFTWARE, EVEN IF ADVISED OF THE POSSIBILITY OF SUCH DAMAGE.

=====

Copyright (C) 2008 by the Massachusetts Institute of Technology.
Copyright 1995 by Richard P. Basch. All Rights Reserved.
Copyright 1995 by Lehman Brothers, Inc. All Rights Reserved.

Export of this software from the United States of America may require a specific license from the United States Government. It is the responsibility of any person or organization contemplating export to obtain such a license before exporting.

WITHIN THAT CONSTRAINT, permission to use, copy, modify, and distribute this software and its documentation for any purpose and without fee is hereby granted, provided that the above copyright



notice appear in all copies and that both that copyright notice and this permission notice appear in supporting documentation, and that the name of Richard P. Basch, Lehman Brothers and M.I.T. not be used in advertising or publicity pertaining to distribution of the software without specific, written prior permission. Richard P. Basch, Lehman Brothers and M.I.T. make no representations about the suitability of this software for any purpose. It is provided "as is" without express or implied warranty.

=====

The following notice applies to "src/lib/krb5/krb/strptime.c" and "src/include/k5-queue.h".

Copyright (C) 1997, 1998 The NetBSD Foundation, Inc.
All rights reserved.

This code was contributed to The NetBSD Foundation by Klaus Klein.

Redistribution and use in source and binary forms, with or without modification, are permitted provided that the following conditions are met:

1. Redistributions of source code must retain the above copyright notice, this list of conditions and the following disclaimer.
2. Redistributions in binary form must reproduce the above copyright notice, this list of conditions and the following disclaimer in the documentation and/or other materials provided with the distribution.
3. All advertising materials mentioning features or use of this software must display the following acknowledgement:

This product includes software developed by the NetBSD Foundation, Inc. and its contributors.



4. Neither the name of The NetBSD Foundation nor the names of its contributors may be used to endorse or promote products derived from this software without specific prior written permission.

THIS SOFTWARE IS PROVIDED BY THE NETBSD FOUNDATION, INC. AND CONTRIBUTORS "AS IS" AND ANY EXPRESS OR IMPLIED WARRANTIES, INCLUDING, BUT NOT LIMITED TO, THE IMPLIED WARRANTIES OF MERCHANTABILITY AND FITNESS FOR A PARTICULAR PURPOSE ARE DISCLAIMED. IN NO EVENT SHALL THE FOUNDATION OR CONTRIBUTORS BE LIABLE FOR ANY DIRECT, INDIRECT, INCIDENTAL, SPECIAL, EXEMPLARY, OR CONSEQUENTIAL DAMAGES (INCLUDING, BUT NOT LIMITED TO, PROCUREMENT OF SUBSTITUTE GOODS OR SERVICES; LOSS OF USE, DATA, OR PROFITS; OR BUSINESS INTERRUPTION) HOWEVER CAUSED AND ON ANY THEORY OF LIABILITY, WHETHER IN CONTRACT, STRICT LIABILITY, OR TORT (INCLUDING NEGLIGENCE OR OTHERWISE) ARISING IN ANY WAY OUT OF THE USE OF THIS SOFTWARE, EVEN IF ADVISED OF THE POSSIBILITY OF SUCH DAMAGE.

=====

The following notice applies to Unicode library files in "src/lib/krb5/unicode":

Copyright 1997, 1998, 1999 Computing Research Labs,
New Mexico State University

Permission is hereby granted, free of charge, to any person obtaining a copy of this software and associated documentation files (the "Software"), to deal in the Software without restriction, including without limitation the rights to use, copy, modify, merge, publish, distribute, sublicense, and/or sell copies of the Software, and to permit persons to whom the Software is furnished to do so, subject to the following conditions:

The above copyright notice and this permission notice shall be included in all copies or substantial portions of the Software.



THE SOFTWARE IS PROVIDED "AS IS", WITHOUT WARRANTY OF ANY KIND, EXPRESS OR IMPLIED, INCLUDING BUT NOT LIMITED TO THE WARRANTIES OF MERCHANTABILITY, FITNESS FOR A PARTICULAR PURPOSE AND NONINFRINGEMENT. IN NO EVENT SHALL THE COMPUTING RESEARCH LAB OR NEW MEXICO STATE UNIVERSITY BE LIABLE FOR ANY CLAIM, DAMAGES OR OTHER LIABILITY, WHETHER IN AN ACTION OF CONTRACT, TORT OR OTHERWISE, ARISING FROM, OUT OF OR IN CONNECTION WITH THE SOFTWARE OR THE USE OR OTHER DEALINGS IN THE SOFTWARE.

=====

The following notice applies to "src/util/support/strncpy.c":

Copyright (C) 1998 Todd C. Miller "Todd.Miller@courtesan.com"

Permission to use, copy, modify, and distribute this software for any purpose with or without fee is hereby granted, provided that the above copyright notice and this permission notice appear in all copies.

THE SOFTWARE IS PROVIDED "AS IS" AND THE AUTHOR DISCLAIMS ALL WARRANTIES WITH REGARD TO THIS SOFTWARE INCLUDING ALL IMPLIED WARRANTIES OF MERCHANTABILITY AND FITNESS. IN NO EVENT SHALL THE AUTHOR BE LIABLE FOR ANY SPECIAL, DIRECT, INDIRECT, OR CONSEQUENTIAL DAMAGES OR ANY DAMAGES WHATSOEVER RESULTING FROM LOSS OF USE, DATA OR PROFITS, WHETHER IN AN ACTION OF CONTRACT, NEGLIGENCE OR OTHER TORTIOUS ACTION, ARISING OUT OF OR IN CONNECTION WITH THE USE OR PERFORMANCE OF THIS SOFTWARE.

=====

The following notice applies to "src/util/profile/argv_parse.c" and "src/util/profile/argv_parse.h":

Copyright 1999 by Theodore Ts'o.

Permission to use, copy, modify, and distribute this software for



any purpose with or without fee is hereby granted, provided that the above copyright notice and this permission notice appear in all copies. THE SOFTWARE IS PROVIDED "AS IS" AND THEODORE TS'O (THE AUTHOR) DISCLAIMS ALL WARRANTIES WITH REGARD TO THIS SOFTWARE, INCLUDING ALL IMPLIED WARRANTIES OF MERCHANTABILITY AND FITNESS. IN NO EVENT SHALL THE AUTHOR BE LIABLE FOR ANY SPECIAL, DIRECT, INDIRECT, OR CONSEQUENTIAL DAMAGES OR ANY DAMAGES WHATSOEVER RESULTING FROM LOSS OF USE, DATA OR PROFITS, WHETHER IN AN ACTION OF CONTRACT, NEGLIGENCE OR OTHER TORTIOUS ACTION, ARISING OUT OF OR IN CONNECTION WITH THE USE OR PERFORMANCE OF THIS SOFTWARE. (Isn't it sick that the U.S. culture of lawsuit-happy lawyers requires this kind of disclaimer?)

=====

The following notice applies to SWIG-generated code in "src/util/profile/profile_tcl.c":

Copyright (C) 1999-2000, The University of Chicago

This file may be freely redistributed without license or fee provided this copyright message remains intact.

=====

The following notice applies to portions of "src/lib/rpc" and "src/include/gssrpc":

Copyright (C) 2000 The Regents of the University of Michigan. All rights reserved.

Copyright (C) 2000 Dug Song "dugsong@UMICH.EDU". All rights reserved, all wrongs reversed.

Redistribution and use in source and binary forms, with or without modification, are permitted provided that the following conditions are met:



1. Redistributions of source code must retain the above copyright notice, this list of conditions and the following disclaimer.
2. Redistributions in binary form must reproduce the above copyright notice, this list of conditions and the following disclaimer in the documentation and/or other materials provided with the distribution.
3. Neither the name of the University nor the names of its contributors may be used to endorse or promote products derived from this software without specific prior written permission.

THIS SOFTWARE IS PROVIDED "AS IS" AND ANY EXPRESS OR IMPLIED WARRANTIES, INCLUDING, BUT NOT LIMITED TO, THE IMPLIED WARRANTIES OF MERCHANTABILITY AND FITNESS FOR A PARTICULAR PURPOSE ARE DISCLAIMED. IN NO EVENT SHALL THE REGENTS OR CONTRIBUTORS BE LIABLE FOR ANY DIRECT, INDIRECT, INCIDENTAL, SPECIAL, EXEMPLARY, OR CONSEQUENTIAL DAMAGES (INCLUDING, BUT NOT LIMITED TO, PROCUREMENT OF SUBSTITUTE GOODS OR SERVICES; LOSS OF USE, DATA, OR PROFITS; OR BUSINESS INTERRUPTION) HOWEVER CAUSED AND ON ANY THEORY OF LIABILITY, WHETHER IN CONTRACT, STRICT LIABILITY, OR TORT (INCLUDING NEGLIGENCE OR OTHERWISE) ARISING IN ANY WAY OUT OF THE USE OF THIS SOFTWARE, EVEN IF ADVISED OF THE POSSIBILITY OF SUCH DAMAGE.

=====

Implementations of the MD4 algorithm are subject to the following notice:

Copyright (C) 1990, RSA Data Security, Inc. All rights reserved.

License to copy and use this software is granted provided that it is identified as the "RSA Data Security, Inc. MD4 Message Digest Algorithm" in all material mentioning or referencing this software or this function.



License is also granted to make and use derivative works provided that such works are identified as "derived from the RSA Data Security, Inc. MD4 Message Digest Algorithm" in all material mentioning or referencing the derived work.

RSA Data Security, Inc. makes no representations concerning either the merchantability of this software or the suitability of this software for any particular purpose. It is provided "as is" without express or implied warranty of any kind.

These notices must be retained in any copies of any part of this documentation and/or software.

=====

Implementations of the MD5 algorithm are subject to the following notice:

Copyright (C) 1990, RSA Data Security, Inc. All rights reserved.

License to copy and use this software is granted provided that it is identified as the "RSA Data Security, Inc. MD5 Message- Digest Algorithm" in all material mentioning or referencing this software or this function.

License is also granted to make and use derivative works provided that such works are identified as "derived from the RSA Data Security, Inc. MD5 Message-Digest Algorithm" in all material mentioning or referencing the derived work.

RSA Data Security, Inc. makes no representations concerning either the merchantability of this software or the suitability of this software for any particular purpose. It is provided "as is" without express or implied warranty of any kind.

These notices must be retained in any copies of any part of this



documentation and/or software.

=====

The following notice applies to
"src/lib/crypto/crypto_tests/t_mddriver.c":

Copyright (C) 1990-2, RSA Data Security, Inc. Created 1990. All rights reserved.

RSA Data Security, Inc. makes no representations concerning either the merchantability of this software or the suitability of this software for any particular purpose. It is provided "as is" without express or implied warranty of any kind.

These notices must be retained in any copies of any part of this documentation and/or software.

=====

Portions of "src/lib/krb5" are subject to the following notice:

Copyright (C) 1994 CyberSAFE Corporation.
Copyright 1990,1991,2007,2008 by the Massachusetts Institute of Technology.
All Rights Reserved.

Export of this software from the United States of America may require a specific license from the United States Government. It is the responsibility of any person or organization contemplating export to obtain such a license before exporting.

WITHIN THAT CONSTRAINT, permission to use, copy, modify, and distribute this software and its documentation for any purpose and without fee is hereby granted, provided that the above copyright notice appear in all copies and that both that copyright notice and this permission notice appear in supporting documentation, and that the name of M.I.T. not be used in advertising or publicity



pertaining to distribution of the software without specific, written prior permission. Furthermore if you modify this software you must label your software as modified software and not distribute it in such a fashion that it might be confused with the original M.I.T. software. Neither M.I.T., the Open Computing Security Group, nor CyberSAFE Corporation make any representations about the suitability of this software for any purpose. It is provided "as is" without express or implied warranty.

=====

Portions contributed by PADL Software are subject to the following license:

Copyright (c) 2011, PADL Software Pty Ltd. All rights reserved.

Redistribution and use in source and binary forms, with or without modification, are permitted provided that the following conditions are met:

1. Redistributions of source code must retain the above copyright notice, this list of conditions and the following disclaimer.
2. Redistributions in binary form must reproduce the above copyright notice, this list of conditions and the following disclaimer in the documentation and/or other materials provided with the distribution.
3. Neither the name of PADL Software nor the names of its contributors may be used to endorse or promote products derived from this software without specific prior written permission.

THIS SOFTWARE IS PROVIDED BY PADL SOFTWARE AND CONTRIBUTORS "AS IS" AND ANY EXPRESS OR IMPLIED WARRANTIES, INCLUDING, BUT NOT LIMITED TO, THE IMPLIED WARRANTIES OF MERCHANTABILITY AND FITNESS FOR A PARTICULAR PURPOSE ARE DISCLAIMED. IN NO EVENT SHALL PADL SOFTWARE OR CONTRIBUTORS BE LIABLE FOR ANY DIRECT, INDIRECT, INCIDENTAL,



SPECIAL, EXEMPLARY, OR CONSEQUENTIAL DAMAGES (INCLUDING, BUT NOT LIMITED TO, PROCUREMENT OF SUBSTITUTE GOODS OR SERVICES; LOSS OF USE, DATA, OR PROFITS; OR BUSINESS INTERRUPTION) HOWEVER CAUSED AND ON ANY THEORY OF LIABILITY, WHETHER IN CONTRACT, STRICT LIABILITY, OR TORT (INCLUDING NEGLIGENCE OR OTHERWISE) ARISING IN ANY WAY OUT OF THE USE OF THIS SOFTWARE, EVEN IF ADVISED OF THE POSSIBILITY OF SUCH DAMAGE.

=====

The bundled libev source code is subject to the following license:

All files in libev are Copyright (C)2007,2008,2009 Marc Alexander Lehmann.

Redistribution and use in source and binary forms, with or without modification, are permitted provided that the following conditions are met:

* Redistributions of source code must retain the above copyright notice, this list of conditions and the following disclaimer.

* Redistributions in binary form must reproduce the above copyright notice, this list of conditions and the following disclaimer in the documentation and/or other materials provided with the distribution.

THIS SOFTWARE IS PROVIDED BY THE COPYRIGHT HOLDERS AND CONTRIBUTORS "AS IS" AND ANY EXPRESS OR IMPLIED WARRANTIES, INCLUDING, BUT NOT LIMITED TO, THE IMPLIED WARRANTIES OF MERCHANTABILITY AND FITNESS FOR A PARTICULAR PURPOSE ARE DISCLAIMED. IN NO EVENT SHALL THE COPYRIGHT OWNER OR CONTRIBUTORS BE LIABLE FOR ANY DIRECT, INDIRECT, INCIDENTAL, SPECIAL, EXEMPLARY, OR CONSEQUENTIAL DAMAGES (INCLUDING, BUT NOT LIMITED TO, PROCUREMENT OF SUBSTITUTE GOODS OR SERVICES; LOSS OF USE, DATA, OR PROFITS; OR BUSINESS INTERRUPTION) HOWEVER CAUSED AND ON ANY THEORY OF LIABILITY, WHETHER IN CONTRACT, STRICT LIABILITY, OR TORT (INCLUDING NEGLIGENCE OR OTHERWISE)



ARISING IN ANY WAY OUT OF THE USE OF THIS SOFTWARE, EVEN IF ADVISED OF THE POSSIBILITY OF SUCH DAMAGE.

Alternatively, the contents of this package may be used under the terms of the GNU General Public License ("GPL") version 2 or any later version, in which case the provisions of the GPL are applicable instead of the above. If you wish to allow the use of your version of this package only under the terms of the GPL and not to allow others to use your version of this file under the BSD license, indicate your decision by deleting the provisions above and replace them with the notice and other provisions required by the GPL in this and the other files of this package. If you do not delete the provisions above, a recipient may use your version of this file under either the BSD or the GPL.

=====

Files copied from the Intel AESNI Sample Library are subject to the following license:

Copyright (C) 2010, Intel Corporation
All rights reserved.

Redistribution and use in source and binary forms, with or without modification, are permitted provided that the following conditions are met:

- * Redistributions of source code must retain the above copyright notice, this list of conditions and the following disclaimer.
- * Redistributions in binary form must reproduce the above copyright notice, this list of conditions and the following disclaimer in the documentation and/or other materials provided with the distribution.
- * Neither the name of Intel Corporation nor the names of its contributors may be used to endorse or promote products



derived from this software without specific prior written permission.

THIS SOFTWARE IS PROVIDED BY THE COPYRIGHT HOLDERS AND CONTRIBUTORS "AS IS" AND ANY EXPRESS OR IMPLIED WARRANTIES, INCLUDING, BUT NOT LIMITED TO, THE IMPLIED WARRANTIES OF MERCHANTABILITY AND FITNESS FOR A PARTICULAR PURPOSE ARE DISCLAIMED. IN NO EVENT SHALL THE COPYRIGHT OWNER OR CONTRIBUTORS BE LIABLE FOR ANY DIRECT, INDIRECT, INCIDENTAL, SPECIAL, EXEMPLARY, OR CONSEQUENTIAL DAMAGES (INCLUDING, BUT NOT LIMITED TO, PROCUREMENT OF SUBSTITUTE GOODS OR SERVICES; LOSS OF USE, DATA, OR PROFITS; OR BUSINESS INTERRUPTION) HOWEVER CAUSED AND ON ANY THEORY OF LIABILITY, WHETHER IN CONTRACT, STRICT LIABILITY, OR TORT (INCLUDING NEGLIGENCE OR OTHERWISE) ARISING IN ANY WAY OUT OF THE USE OF THIS SOFTWARE, EVEN IF ADVISED OF THE POSSIBILITY OF SUCH DAMAGE.

=====

The following notice applies to
"src/ccapi/common/win/OldCC/autolock.hxx":

Copyright (C) 1998 by Danilo Almeida. All rights reserved.

Redistribution and use in source and binary forms, with or without modification, are permitted provided that the following conditions are met:

- * Redistributions of source code must retain the above copyright notice, this list of conditions and the following disclaimer.

- * Redistributions in binary form must reproduce the above copyright notice, this list of conditions and the following disclaimer in the documentation and/or other materials provided with the distribution.

THIS SOFTWARE IS PROVIDED BY THE COPYRIGHT HOLDERS AND CONTRIBUTORS "AS IS" AND ANY EXPRESS OR IMPLIED WARRANTIES, INCLUDING, BUT NOT



LIMITED TO, THE IMPLIED WARRANTIES OF MERCHANTABILITY AND FITNESS FOR A PARTICULAR PURPOSE ARE DISCLAIMED. IN NO EVENT SHALL THE COPYRIGHT HOLDER OR CONTRIBUTORS BE LIABLE FOR ANY DIRECT, INDIRECT, INCIDENTAL, SPECIAL, EXEMPLARY, OR CONSEQUENTIAL DAMAGES (INCLUDING, BUT NOT LIMITED TO, PROCUREMENT OF SUBSTITUTE GOODS OR SERVICES; LOSS OF USE, DATA, OR PROFITS; OR BUSINESS INTERRUPTION) HOWEVER CAUSED AND ON ANY THEORY OF LIABILITY, WHETHER IN CONTRACT, STRICT LIABILITY, OR TORT (INCLUDING NEGLIGENCE OR OTHERWISE) ARISING IN ANY WAY OUT OF THE USE OF THIS SOFTWARE, EVEN IF ADVISED OF THE POSSIBILITY OF SUCH DAMAGE.

MIT-like License (libxkbcommon)

The following is a list of all copyright notices and license statements which appear in the xkbcommon source tree.

If making new contributions, the first form (i.e. Daniel Stone, Ran Benita, etc) is vastly preferred.

All licenses are derivative of the MIT/X11 license, mostly identical other than no-endorsement clauses (e.g. paragraph 4 of The Open Group's license).

These statements are split into two sections: one for the code compiled and distributed as part of the libxkbcommon shared library and the code component of all tests (i.e. everything under `src/` and `xkbcommon/`, plus the `.c` and `.h` files under `test/`), and another for the test data under `test/data`, which is distributed with the xkbcommon source tarball, but not installed to the system.

BEGINNING OF SOFTWARE COPYRIGHT/LICENSE STATEMENTS:

Copyright(c) 2009-2012 Daniel Stone
 Copyright(c) 2012 Ran Benita <ran234@gmail.com>
 Copyright(c) 2010, 2012 Intel Corporation
 Copyright(c) 2008, 2009 Dan Nicholson
 Copyright(c) 2010 Francisco Jerez <currojerez@riseup.net>

Permission is hereby granted, free of charge, to any person obtaining a copy of this software



and associated documentation files (the "Software"), to deal in the Software without restriction, including without limitation the rights to use, copy, modify, merge, publish, distribute, sublicense, and/or sell copies of the Software, and to permit persons to whom the Software is furnished to do so, subject to the following conditions:

The above copyright notice and this permission notice (including the next paragraph) shall be included in all copies or substantial portions of the Software.

THE SOFTWARE IS PROVIDED "AS IS", WITHOUT WARRANTY OF ANY KIND, EXPRESS OR IMPLIED, INCLUDING BUT NOT LIMITED TO THE WARRANTIES OF MERCHANTABILITY, FITNESS FOR A PARTICULAR PURPOSE AND NONINFRINGEMENT. IN NO EVENT SHALL THE AUTHORS OR COPYRIGHT HOLDERS BE LIABLE FOR ANY CLAIM, DAMAGES OR OTHER LIABILITY, WHETHER IN AN ACTION OF CONTRACT, TORT OR OTHERWISE, ARISING FROM, OUT OF OR IN CONNECTION WITH THE SOFTWARE OR THE USE OR OTHER DEALINGS IN THE SOFTWARE.

Copyright 1985, 1987, 1988, 1990, 1998 The Open Group

Permission is hereby granted, free of charge, to any person obtaining a copy of this software and associated documentation files (the "Software"), to deal in the Software without restriction, including without limitation the rights to use, copy, modify, merge, publish, distribute, sublicense, and/or sell copies of the Software, and to permit persons to whom the Software is furnished to do so, subject to the following conditions:

The above copyright notice and this permission notice shall be included in all copies or substantial portions of the Software.

THE SOFTWARE IS PROVIDED "AS IS", WITHOUT WARRANTY OF ANY KIND, EXPRESS OR IMPLIED, INCLUDING BUT NOT LIMITED TO THE WARRANTIES OF MERCHANTABILITY, FITNESS FOR A PARTICULAR PURPOSE AND NONINFRINGEMENT. IN NO EVENT SHALL THE AUTHORS BE LIABLE FOR ANY CLAIM, DAMAGES OR OTHER LIABILITY, WHETHER IN AN ACTION OF CONTRACT, TORT OR OTHERWISE, ARISING FROM, OUT OF OR IN CONNECTION WITH THE SOFTWARE OR THE USE OR OTHER DEALINGS IN THE SOFTWARE.

Except as contained in this notice, the names of the authors or their institutions shall not be used in advertising or otherwise to promote the sale, use or other dealings in this Software without prior written authorization from the authors.



Copyright (c) 1993, 1994, 1995, 1996 by Silicon Graphics Computer Systems, Inc.

Permission to use, copy, modify, and distribute this software and its documentation for any purpose and without fee is hereby granted, provided that the above copyright notice appear in all copies and that both that copyright notice and this permission notice appear in supporting documentation, and that the name of Silicon Graphics not be used in advertising or publicity pertaining to distribution of the software without specific prior written permission.

Silicon Graphics makes no representation about the suitability of this software for any purpose. It is provided "as is" without any express or implied warranty.

SILICON GRAPHICS DISCLAIMS ALL WARRANTIES WITH REGARD TO THIS SOFTWARE, INCLUDING ALL IMPLIED WARRANTIES OF MERCHANTABILITY AND FITNESS FOR A PARTICULAR PURPOSE. IN NO EVENT SHALL SILICON GRAPHICS BE LIABLE FOR ANY SPECIAL, INDIRECT OR CONSEQUENTIAL DAMAGES OR ANY DAMAGES WHATSOEVER RESULTING FROM LOSS OF USE, DATA OR PROFITS, WHETHER IN AN ACTION OF CONTRACT, NEGLIGENCE OR OTHER TORTIOUS ACTION, ARISING OUT OF OR IN CONNECTION WITH THE USE OR PERFORMANCE OF THIS SOFTWARE.

Copyright 1987, 1988 by Digital Equipment Corporation, Maynard, Massachusetts.
All Rights Reserved

Permission to use, copy, modify, and distribute this software and its documentation for any purpose and without fee is hereby granted, provided that the above copyright notice appear in all copies and that both that copyright notice and this permission notice appear in supporting documentation, and that the name of Digital not be used in advertising or publicity pertaining to distribution of the software without specific, written prior permission.

DIGITAL DISCLAIMS ALL WARRANTIES WITH REGARD TO THIS SOFTWARE, INCLUDING ALL IMPLIED WARRANTIES OF MERCHANTABILITY AND FITNESS, IN NO EVENT SHALL DIGITAL BE LIABLE FOR ANY SPECIAL, INDIRECT OR CONSEQUENTIAL DAMAGES OR ANY DAMAGES WHATSOEVER RESULTING FROM LOSS OF USE, DATA OR PROFITS, WHETHER IN AN ACTION OF CONTRACT, NEGLIGENCE OR OTHER TORTIOUS ACTION, ARISING OUT OF OR IN CONNECTION WITH THE USE OR PERFORMANCE OF THIS SOFTWARE.

Copyright (C) 2011 Joseph Adams <joeyadams3.14159@gmail.com>

Permission is hereby granted, free of charge, to any person obtaining a copy of this software



and associated documentation files (the "Software"), to deal in the Software without restriction, including without limitation the rights to use, copy, modify, merge, publish, distribute, sublicense, and/or sell copies of the Software, and to permit persons to whom the Software is furnished to do so, subject to the following conditions:

The above copyright notice and this permission notice shall be included in all copies or substantial portions of the Software.

THE SOFTWARE IS PROVIDED "AS IS", WITHOUT WARRANTY OF ANY KIND, EXPRESS OR IMPLIED, INCLUDING BUT NOT LIMITED TO THE WARRANTIES OF MERCHANTABILITY, FITNESS FOR A PARTICULAR PURPOSE AND NONINFRINGEMENT. IN NO EVENT SHALL THE AUTHORS OR COPYRIGHT HOLDERS BE LIABLE FOR ANY CLAIM, DAMAGES OR OTHER LIABILITY, WHETHER IN AN ACTION OF CONTRACT, TORT OR OTHERWISE, ARISING FROM, OUT OF OR IN CONNECTION WITH THE SOFTWARE OR THE USE OR OTHER DEALINGS IN THE SOFTWARE.

END OF SOFTWARE COPYRIGHT/LICENSE STATEMENTS

BEGINNING OF LICENSE STATEMENTS FOR UNDISTRIBUTED DATA FILES IN test/data, derived from xkeyboard-config:

Copyright 1996 by Joseph Moss
Copyright (C) 2002-2007 Free Software Foundation, Inc.
Copyright (C) Dmitry Golubev <lastguru@mail.ru>, 2003-2004
Copyright (C) 2004, Gregory Mokhin <mokhin@bog.msu.ru>
Copyright (C) 2006 Erdal Ronah

Permission to use, copy, modify, distribute, and sell this software and its documentation for any purpose is hereby granted without fee, provided that the above copyright notice appear in all copies and that both that copyright notice and this permission notice appear in supporting documentation, and that the name of the copyright holder(s) not be used in advertising or publicity pertaining to distribution of the software without specific, written prior permission.

The copyright holder(s) makes no representations about the suitability of this software for any purpose.

It is provided "as is" without express or implied warranty.

THE COPYRIGHT HOLDER(S) DISCLAIMS ALL WARRANTIES WITH REGARD TO THIS

SOFTWARE, INCLUDING ALL IMPLIED WARRANTIES OF MERCHANTABILITY AND FITNESS, IN NO EVENT SHALL THE COPYRIGHT HOLDER(S) BE LIABLE FOR ANY SPECIAL, INDIRECT OR CONSEQUENTIAL DAMAGES OR ANY DAMAGES WHATSOEVER RESULTING FROM LOSS OF USE, DATA OR PROFITS, WHETHER IN AN ACTION OF CONTRACT, NEGLIGENCE OR OTHER TORTIOUS ACTION, ARISING OUT OF OR IN CONNECTION WITH THE USE OR PERFORMANCE OF THIS SOFTWARE.

MIT-like License (libxml2)

Copyright (C) 1998-2003 Daniel Veillard. All Rights Reserved.

Permission is hereby granted, free of charge, to any person obtaining a copy of this software and associated documentation files (the "Software"), to deal in the Software without restriction, including without limitation the rights to use, copy, modify, merge, publish, distribute, sublicense, and/or sell copies of the Software, and to permit persons to whom the Software is furnished to do so, subject to the following conditions:

The above copyright notice and this permission notice shall be included in all copies or substantial portions of the Software.

THE SOFTWARE IS PROVIDED "AS IS", WITHOUT WARRANTY OF ANY KIND, EXPRESS OR IMPLIED, INCLUDING BUT NOT LIMITED TO THE WARRANTIES OF MERCHANTABILITY, FITNESS FOR A PARTICULAR PURPOSE AND NONINFRINGEMENT. IN NO EVENT SHALL THE DANIEL VEILLARD BE LIABLE FOR ANY CLAIM, DAMAGES OR OTHER LIABILITY, WHETHER IN AN ACTION OF CONTRACT, TORT OR OTHERWISE, ARISING FROM, OUT OF OR IN CONNECTION WITH THE SOFTWARE OR THE USE OR OTHER DEALINGS IN THE SOFTWARE.

Except as contained in this notice, the name of Daniel Veillard shall not be used in advertising or otherwise to promote the sale, use or other dealings in this Software without prior written authorization from him.

MIT-like License (Isof)

This software is not subject to any license of the American Telephone and Telegraph Company or the Regents of the University of California.

Permission is granted to anyone to use this software for any purpose on any computer system,

and to alter it and redistribute it freely, subject to the following restrictions:

1. Neither the authors nor Purdue University are responsible for any consequences of the use of this software.
2. The origin of this software must not be misrepresented, either by explicit claim or by omission. Credit to the authors and Purdue University must appear in documentation and sources.
3. Altered versions must be plainly marked as such, and must not be misrepresented as being the original software.
4. This notice may not be removed or altered.

MIT-like License (ncurses)

Copyright (c) 1999-2004,2005 Free Software Foundation, Inc.

Permission is hereby granted, free of charge, to any person obtaining a copy of this software and associated documentation files (the "Software"), to deal in the Software without restriction, including without limitation the rights to use, copy, modify, merge, publish, distribute, distribute with modifications, sublicense, and/or sell copies of the Software, and to permit persons to whom the Software is furnished to do so, subject to the following conditions:

The above copyright notice and this permission notice shall be included in all copies or substantial portions of the Software.

THE SOFTWARE IS PROVIDED "AS IS", WITHOUT WARRANTY OF ANY KIND, EXPRESS OR IMPLIED, INCLUDING BUT NOT LIMITED TO THE WARRANTIES OF MERCHANTABILITY, FITNESS FOR A PARTICULAR PURPOSE AND NONINFRINGEMENT. IN NO EVENT SHALL THE ABOVE COPYRIGHT HOLDERS BE LIABLE FOR ANY CLAIM, DAMAGES OR OTHER LIABILITY, WHETHER IN AN ACTION OF CONTRACT, TORT OR OTHERWISE, ARISING FROM, OUT OF OR IN CONNECTION WITH THE SOFTWARE OR THE USE OR OTHER DEALINGS IN THE SOFTWARE.

Except as contained in this notice, the name(s) of the above copyright holders shall not be used in advertising or otherwise to promote the sale, use or other dealings in this Software without prior written authorization.

MIT-like License (sudo)

Sudo is distributed under the following license:

Copyright (c) 1994-1996, 1998-2013

Todd C. Miller <Todd.Miller@courtesan.com>

Permission to use, copy, modify, and distribute this software for any purpose with or without fee is hereby granted, provided that the above copyright notice and this permission notice appear in all copies.

THE SOFTWARE IS PROVIDED "AS IS" AND THE AUTHOR DISCLAIMS ALL WARRANTIES WITH REGARD TO THIS SOFTWARE INCLUDING ALL IMPLIED WARRANTIES OF MERCHANTABILITY AND FITNESS. IN NO EVENT SHALL THE AUTHOR BE LIABLE FOR ANY SPECIAL, DIRECT, INDIRECT, OR CONSEQUENTIAL DAMAGES OR ANY DAMAGES WHATSOEVER RESULTING FROM LOSS OF USE, DATA OR PROFITS, WHETHER IN AN ACTION OF CONTRACT, NEGLIGENCE OR OTHER TORTIOUS ACTION, ARISING OUT OF OR IN CONNECTION WITH THE USE OR PERFORMANCE OF THIS SOFTWARE.

Sponsored in part by the Defense Advanced Research Projects Agency (DARPA) and Air Force Research Laboratory, Air Force Materiel Command, USAF, under agreement number F39502-99-1-0512.

The file redblack.c bears the following license:

Copyright (c) 2001 Emin Martinian

Redistribution and use in source and binary forms, with or without modification, are permitted provided that neither the name of Emin Martinian nor the names of any contributors are be used to endorse or promote products derived from this software without specific prior written permission.

THIS SOFTWARE IS PROVIDED BY THE COPYRIGHT HOLDERS AND CONTRIBUTORS "AS IS" AND ANY EXPRESS OR IMPLIED WARRANTIES, INCLUDING, BUT NOT LIMITED TO, THE IMPLIED WARRANTIES OF MERCHANTABILITY AND FITNESS FOR

A PARTICULAR PURPOSE ARE DISCLAIMED. IN NO EVENT SHALL THE COPYRIGHT OWNER OR CONTRIBUTORS BE LIABLE FOR ANY DIRECT, INDIRECT, INCIDENTAL, SPECIAL, EXEMPLARY, OR CONSEQUENTIAL DAMAGES (INCLUDING, BUT NOT LIMITED TO, PROCUREMENT OF SUBSTITUTE GOODS OR SERVICES; LOSS OF USE, DATA, OR PROFITS; OR BUSINESS INTERRUPTION) HOWEVER CAUSED AND ON ANY THEORY OF LIABILITY, WHETHER IN CONTRACT, STRICT LIABILITY, OR TORT (INCLUDING NEGLIGENCE OR OTHERWISE) ARISING IN ANY WAY OUT OF THE USE OF THIS SOFTWARE, EVEN IF ADVISED OF THE POSSIBILITY OF SUCH DAMAGE.

The files `getcwd.c`, `glob.c`, `glob.h` and `snprintf.c` bear the following license:

Copyright (c) 1989, 1990, 1991, 1993

The Regents of the University of California. All rights reserved.

Redistribution and use in source and binary forms, with or without modification, are permitted provided that the following conditions are met:

1. Redistributions of source code must retain the above copyright notice, this list of conditions and the following disclaimer.
2. Redistributions in binary form must reproduce the above copyright notice, this list of conditions and the following disclaimer in the documentation and/or other materials provided with the distribution.
3. Neither the name of the University nor the names of its contributors may be used to endorse or promote products derived from this software without specific prior written permission.

THIS SOFTWARE IS PROVIDED BY THE REGENTS AND CONTRIBUTORS ``AS IS'' AND ANY EXPRESS OR IMPLIED WARRANTIES, INCLUDING, BUT NOT LIMITED TO, THE IMPLIED WARRANTIES OF MERCHANTABILITY AND FITNESS FOR A PARTICULAR PURPOSE ARE DISCLAIMED. IN NO EVENT SHALL THE REGENTS OR CONTRIBUTORS BE LIABLE FOR ANY DIRECT, INDIRECT, INCIDENTAL, SPECIAL, EXEMPLARY, OR CONSEQUENTIAL DAMAGES (INCLUDING, BUT NOT LIMITED TO, PROCUREMENT OF SUBSTITUTE GOODS OR SERVICES; LOSS OF USE, DATA, OR PROFITS; OR BUSINESS INTERRUPTION) HOWEVER CAUSED AND ON ANY THEORY OF LIABILITY, WHETHER IN CONTRACT, STRICT LIABILITY, OR TORT (INCLUDING NEGLIGENCE OR OTHERWISE) ARISING IN ANY WAY OUT OF THE USE OF THIS SOFTWARE, EVEN IF ADVISED OF THE POSSIBILITY OF SUCH DAMAGE.



The file `fnmatch.c` bears the following license:

Copyright (c) 2011, VMware, Inc.
All rights reserved.

Redistribution and use in source and binary forms, with or without modification, are permitted provided that the following conditions are met:

- * Redistributions of source code must retain the above copyright notice, this list of conditions and the following disclaimer.
- * Redistributions in binary form must reproduce the above copyright notice, this list of conditions and the following disclaimer in the documentation and/or other materials provided with the distribution.
- * Neither the name of the VMware, Inc. nor the names of its contributors may be used to endorse or promote products derived from this software without specific prior written permission.

THIS SOFTWARE IS PROVIDED BY THE COPYRIGHT HOLDERS AND CONTRIBUTORS "AS IS" AND ANY EXPRESS OR IMPLIED WARRANTIES, INCLUDING, BUT NOT LIMITED TO, THE IMPLIED WARRANTIES OF MERCHANTABILITY AND FITNESS FOR A PARTICULAR PURPOSE ARE DISCLAIMED. IN NO EVENT SHALL VMWARE, INC. OR CONTRIBUTORS BE LIABLE FOR ANY DIRECT, INDIRECT, INCIDENTAL, SPECIAL, EXEMPLARY, OR CONSEQUENTIAL DAMAGES (INCLUDING, BUT NOT LIMITED TO, PROCUREMENT OF SUBSTITUTE GOODS OR SERVICES; LOSS OF USE, DATA, OR PROFITS; OR BUSINESS INTERRUPTION) HOWEVER CAUSED AND ON ANY THEORY OF LIABILITY, WHETHER IN CONTRACT, STRICT LIABILITY, OR TORT (INCLUDING NEGLIGENCE OR OTHERWISE) ARISING IN ANY WAY OUT OF THE USE OF THIS SOFTWARE, EVEN IF ADVISED OF THE POSSIBILITY OF SUCH DAMAGE.

The embedded copy of `zlib` bears the following license:

Copyright (C) 1995-2012 Jean-loup Gailly and Mark Adler

This software is provided 'as-is', without any express or implied warranty. In no event will the authors be held liable for any damages arising from the use of this software.

Permission is granted to anyone to use this software for any purpose,

including commercial applications, and to alter it and redistribute it freely, subject to the following restrictions:

1. The origin of this software must not be misrepresented; you must not claim that you wrote the original software. If you use this software in a product, an acknowledgment in the product documentation would be appreciated but is not required.
2. Altered source versions must be plainly marked as such, and must not be misrepresented as being the original software.
3. This notice may not be removed or altered from any source distribution.

Jean-loup Gailly Mark Adler
jloup@gzip.org madler@alumni.caltech.edu

MIT-like License (util-macros)

Copyright 2005 Red Hat, Inc.

Permission to use, copy, modify, distribute, and sell this software and its documentation for any purpose is hereby granted without fee, provided that the above copyright notice appear in all copies and that both that copyright notice and this permission notice appear in supporting documentation, and that the name of Red Hat not be used in advertising or publicity pertaining to distribution of the software without specific, written prior permission. Red Hat makes no representations about the suitability of this software for any purpose. It is provided "as is" without express or implied warranty.

RED HAT DISCLAIMS ALL WARRANTIES WITH REGARD TO THIS SOFTWARE, INCLUDING ALL IMPLIED WARRANTIES OF MERCHANTABILITY AND FITNESS, IN NO EVENT SHALL RED HAT BE LIABLE FOR ANY SPECIAL, INDIRECT OR CONSEQUENTIAL DAMAGES OR ANY DAMAGES WHATSOEVER RESULTING FROM LOSS OF USE, DATA OR PROFITS, WHETHER IN AN ACTION OF CONTRACT, NEGLIGENCE OR OTHER TORTIOUS ACTION, ARISING OUT OF OR IN CONNECTION WITH THE USE OR PERFORMANCE OF THIS SOFTWARE.

Copyright (c) 2005, 2006, Oracle and/or its affiliates. All rights reserved.

Permission is hereby granted, free of charge, to any person obtaining a copy of this software and associated documentation files (the "Software"), to deal in the Software without restriction, including without limitation the rights to use, copy, modify, merge, publish, distribute, sublicense, and/or sell copies of the Software, and to permit persons to whom the Software is furnished to do so, subject to the following conditions:

The above copyright notice and this permission notice (including the next paragraph) shall be included in all copies or substantial portions of the Software.

THE SOFTWARE IS PROVIDED "AS IS", WITHOUT WARRANTY OF ANY KIND, EXPRESS OR IMPLIED, INCLUDING BUT NOT LIMITED TO THE WARRANTIES OF MERCHANTABILITY, FITNESS FOR A PARTICULAR PURPOSE AND NONINFRINGEMENT. IN NO EVENT SHALL THE AUTHORS OR COPYRIGHT HOLDERS BE LIABLE FOR ANY CLAIM, DAMAGES OR OTHER LIABILITY, WHETHER IN AN ACTION OF CONTRACT, TORT OR OTHERWISE, ARISING FROM, OUT OF OR IN CONNECTION WITH THE SOFTWARE OR THE USE OR OTHER DEALINGS IN THE SOFTWARE.

MIT-like License (xkeyboard-config)

Copyright 1996 by Joseph Moss

Copyright (C) 2002-2007 Free Software Foundation, Inc.

Copyright (C) Dmitry Golubev <lastguru@mail.ru>, 2003-2004

Copyright (C) 2004, Gregory Mokhin <mokhin@bog.msu.ru>

Copyright (C) 2006 Erdal Ronahî

Permission to use, copy, modify, distribute, and sell this software and its documentation for any purpose is hereby granted without fee, provided that the above copyright notice appear in all copies and that both that copyright notice and this permission notice appear in supporting documentation, and that the name of the copyright holder(s) not be used in advertising or publicity pertaining to distribution of the software without



specific, written prior permission. The copyright holder(s) makes no representations about the suitability of this software for any purpose. It is provided "as is" without express or implied warranty.

THE COPYRIGHT HOLDER(S) DISCLAIMS ALL WARRANTIES WITH REGARD TO THIS SOFTWARE, INCLUDING ALL IMPLIED WARRANTIES OF MERCHANTABILITY AND FITNESS, IN NO EVENT SHALL THE COPYRIGHT HOLDER(S) BE LIABLE FOR ANY SPECIAL, INDIRECT OR CONSEQUENTIAL DAMAGES OR ANY DAMAGES WHATSOEVER RESULTING FROM LOSS OF USE, DATA OR PROFITS, WHETHER IN AN ACTION OF CONTRACT, NEGLIGENCE OR OTHER TORTIOUS ACTION, ARISING OUT OF OR IN CONNECTION WITH THE USE OR PERFORMANCE OF THIS SOFTWARE.

Copyright (c) 1996 Digital Equipment Corporation

Permission is hereby granted, free of charge, to any person obtaining a copy of this software and associated documentation files (the "Software"), to deal in the Software without restriction, including without limitation the rights to use, copy, modify, merge, publish, distribute, sublicense, and sell copies of the Software, and to permit persons to whom the Software is furnished to do so, subject to the following conditions:

The above copyright notice and this permission notice shall be included in all copies or substantial portions of the Software.

THE SOFTWARE IS PROVIDED "AS IS", WITHOUT WARRANTY OF ANY KIND, EXPRESS OR IMPLIED, INCLUDING BUT NOT LIMITED TO THE WARRANTIES OF MERCHANTABILITY, FITNESS FOR A PARTICULAR PURPOSE AND NONINFRINGEMENT. IN NO EVENT SHALL DIGITAL EQUIPMENT CORPORATION BE LIABLE FOR ANY CLAIM, DAMAGES OR OTHER LIABILITY, WHETHER IN AN ACTION OF CONTRACT, TORT OR OTHERWISE, ARISING FROM, OUT OF OR IN CONNECTION WITH THE SOFTWARE OR THE USE OR OTHER DEALINGS IN THE SOFTWARE.

Except as contained in this notice, the name of the Digital Equipment Corporation shall not be used in advertising or otherwise to promote



the sale, use or other dealings in this Software without prior written authorization from Digital Equipment Corporation.

Copyright 1996, 1998 The Open Group

Permission to use, copy, modify, distribute, and sell this software and its documentation for any purpose is hereby granted without fee, provided that the above copyright notice appear in all copies and that both that copyright notice and this permission notice appear in supporting documentation.

The above copyright notice and this permission notice shall be included in all copies or substantial portions of the Software.

THE SOFTWARE IS PROVIDED "AS IS", WITHOUT WARRANTY OF ANY KIND, EXPRESS OR IMPLIED, INCLUDING BUT NOT LIMITED TO THE WARRANTIES OF MERCHANTABILITY, FITNESS FOR A PARTICULAR PURPOSE AND NONINFRINGEMENT. IN NO EVENT SHALL THE OPEN GROUP BE LIABLE FOR ANY CLAIM, DAMAGES OR OTHER LIABILITY, WHETHER IN AN ACTION OF CONTRACT, TORT OR OTHERWISE, ARISING FROM, OUT OF OR IN CONNECTION WITH THE SOFTWARE OR THE USE OR OTHER DEALINGS IN THE SOFTWARE.

Except as contained in this notice, the name of The Open Group shall not be used in advertising or otherwise to promote the sale, use or other dealings in this Software without prior written authorization from The Open Group.

Copyright 2004-2005 Sun Microsystems, Inc. All rights reserved.

Permission is hereby granted, free of charge, to any person obtaining a copy of this software and associated documentation files (the "Software"), to deal in the Software without restriction, including without limitation the rights to use, copy, modify, merge, publish, distribute, and/or sell copies of the Software, and to permit persons to whom the Software is furnished to do so, provided that the above



copyright notice(s) and this permission notice appear in all copies of the Software and that both the above copyright notice(s) and this permission notice appear in supporting documentation.

THE SOFTWARE IS PROVIDED "AS IS", WITHOUT WARRANTY OF ANY KIND, EXPRESS OR IMPLIED, INCLUDING BUT NOT LIMITED TO THE WARRANTIES OF MERCHANTABILITY, FITNESS FOR A PARTICULAR PURPOSE AND NONINFRINGEMENT OF THIRD PARTY RIGHTS. IN NO EVENT SHALL THE COPYRIGHT HOLDER OR HOLDERS INCLUDED IN THIS NOTICE BE LIABLE FOR ANY CLAIM, OR ANY SPECIAL INDIRECT OR CONSEQUENTIAL DAMAGES, OR ANY DAMAGES WHATSOEVER RESULTING FROM LOSS OF USE, DATA OR PROFITS, WHETHER IN AN ACTION OF CONTRACT, NEGLIGENCE OR OTHER TORTIOUS ACTION, ARISING OUT OF OR IN CONNECTION WITH THE USE OR PERFORMANCE OF THIS SOFTWARE.

Except as contained in this notice, the name of a copyright holder shall not be used in advertising or otherwise to promote the sale, use or other dealings in this Software without prior written authorization of the copyright holder.

Copyright (c) 1996 by Silicon Graphics Computer Systems, Inc.

Permission to use, copy, modify, and distribute this software and its documentation for any purpose and without fee is hereby granted, provided that the above copyright notice appear in all copies and that both that copyright notice and this permission notice appear in supporting documentation, and that the name of Silicon Graphics not be used in advertising or publicity pertaining to distribution of the software without specific prior written permission. Silicon Graphics makes no representation about the suitability of this software for any purpose. It is provided "as is" without any express or implied warranty.

SILICON GRAPHICS DISCLAIMS ALL WARRANTIES WITH REGARD TO THIS SOFTWARE, INCLUDING ALL IMPLIED WARRANTIES OF MERCHANTABILITY AND FITNESS FOR A PARTICULAR PURPOSE. IN NO EVENT SHALL SILICON



GRAPHICS BE LIABLE FOR ANY SPECIAL, INDIRECT OR CONSEQUENTIAL DAMAGES OR ANY DAMAGES WHATSOEVER RESULTING FROM LOSS OF USE, DATA OR PROFITS, WHETHER IN AN ACTION OF CONTRACT, NEGLIGENCE OR OTHER TORTIOUS ACTION, ARISING OUT OF OR IN CONNECTION WITH THE USE OR PERFORMANCE OF THIS SOFTWARE.

Copyright (c) 1996 X Consortium

Permission is hereby granted, free of charge, to any person obtaining a copy of this software and associated documentation files (the "Software"), to deal in the Software without restriction, including without limitation the rights to use, copy, modify, merge, publish, distribute, sublicense, and/or sell copies of the Software, and to permit persons to whom the Software is furnished to do so, subject to the following conditions:

The above copyright notice and this permission notice shall be included in all copies or substantial portions of the Software.

THE SOFTWARE IS PROVIDED "AS IS", WITHOUT WARRANTY OF ANY KIND, EXPRESS OR IMPLIED, INCLUDING BUT NOT LIMITED TO THE WARRANTIES OF MERCHANTABILITY, FITNESS FOR A PARTICULAR PURPOSE AND NONINFRINGEMENT. IN NO EVENT SHALL THE X CONSORTIUM BE LIABLE FOR ANY CLAIM, DAMAGES OR OTHER LIABILITY, WHETHER IN AN ACTION OF CONTRACT, TORT OR OTHERWISE, ARISING FROM, OUT OF OR IN CONNECTION WITH THE SOFTWARE OR THE USE OR OTHER DEALINGS IN THE SOFTWARE.

Except as contained in this notice, the name of the X Consortium shall not be used in advertising or otherwise to promote the sale, use or other dealings in this Software without prior written authorization from the X Consortium.

Copyright (C) 2004, 2006 Ævar Arnfjörð Bjarmason <avarab@gmail.com>

Permission to use, copy, modify, distribute, and sell this software and its

documentation for any purpose is hereby granted without fee, provided that the above copyright notice appear in all copies and that both that copyright notice and this permission notice appear in supporting documentation.

The above copyright notice and this permission notice shall be included in all copies or substantial portions of the Software.

THE SOFTWARE IS PROVIDED "AS IS", WITHOUT WARRANTY OF ANY KIND, EXPRESS OR IMPLIED, INCLUDING BUT NOT LIMITED TO THE WARRANTIES OF MERCHANTABILITY, FITNESS FOR A PARTICULAR PURPOSE AND NONINFRINGEMENT. IN NO EVENT SHALL THE OPEN GROUP BE LIABLE FOR ANY CLAIM, DAMAGES OR OTHER LIABILITY, WHETHER IN AN ACTION OF CONTRACT, TORT OR OTHERWISE, ARISING FROM, OUT OF OR IN CONNECTION WITH THE SOFTWARE OR THE USE OR OTHER DEALINGS IN THE SOFTWARE.

Except as contained in this notice, the name of a copyright holder shall not be used in advertising or otherwise to promote the sale, use or other dealings in this Software without prior written authorization of the copyright holder.

Copyright (C) 1999, 2000 by Anton Zinoviev <anton@lml.bas.bg>

This software may be used, modified, copied, distributed, and sold, in both source and binary form provided that the above copyright and these terms are retained. Under no circumstances is the author responsible for the proper functioning of this software, nor does the author assume any responsibility for damages incurred with its use.

Permission is granted to anyone to use, distribute and modify this file in any way, provided that the above copyright notice is left intact and the author of the modification summarizes the changes in this header.

This file is distributed without any expressed or implied warranty.

MPL-1.1

Mozilla Public License Version 1.1

1. Definitions.

1.0.1. "Commercial Use" means distribution or otherwise making the Covered Code available to a third party.

1.1. "Contributor" means each entity that creates or contributes to the creation of Modifications.

1.2. "Contributor Version" means the combination of the Original Code, prior Modifications used by a Contributor, and the Modifications made by that particular Contributor.

1.3. "Covered Code" means the Original Code or Modifications or the combination of the Original Code and Modifications, in each case including portions thereof.

1.4. "Electronic Distribution Mechanism" means a mechanism generally accepted in the software development community for the electronic transfer of data.

1.5. "Executable" means Covered Code in any form other than Source Code.

1.6. "Initial Developer" means the individual or entity identified as the Initial Developer in the Source Code notice required by Exhibit A.

1.7. "Larger Work" means a work which combines Covered Code or portions thereof with code not governed by the terms of this License.

1.8. "License" means this document.

1.8.1. "Licensable" means having the right to grant, to the maximum extent possible, whether at the time of the initial grant or subsequently acquired, any and all of the rights conveyed herein.

1.9. "Modifications" means any addition to or deletion from the substance or structure of either the Original Code or any previous Modifications. When Covered Code is released as a series of files, a Modification is:

Any addition to or deletion from the contents of a file containing Original Code or previous

Modifications.

Any new file that contains any part of the Original Code or previous Modifications.

1.10. "Original Code" means Source Code of computer software code which is described in the Source Code notice required by Exhibit A as Original Code, and which, at the time of its release under this License is not already Covered Code governed by this License.

1.10.1. "Patent Claims" means any patent claim(s), now owned or hereafter acquired, including without limitation, method, process, and apparatus claims, in any patent Licensable by grantor.

1.11. "Source Code" means the preferred form of the Covered Code for making modifications to it, including all modules it contains, plus any associated interface definition files, scripts used to control compilation and installation of an Executable, or source code differential comparisons against either the Original Code or another well known, available Covered Code of the Contributor's choice. The Source Code can be in a compressed or archival form, provided the appropriate decompression or de-archiving software is widely available for no charge.

1.12. "You" (or "Your") means an individual or a legal entity exercising rights under, and complying with all of the terms of, this License or a future version of this License issued under Section 6.1. For legal entities, "You" includes any entity which controls, is controlled by, or is under common control with You. For purposes of this definition, "control" means (a) the power, direct or indirect, to cause the direction or management of such entity, whether by contract or otherwise, or (b) ownership of more than fifty percent (50%) of the outstanding shares or beneficial ownership of such entity.

2. Source Code License.

2.1. The Initial Developer Grant. The Initial Developer hereby grants You a world-wide, royalty-free, non-exclusive license, subject to third party intellectual property claims:

- a. under intellectual property rights (other than patent or trademark) Licensable by Initial Developer to use, reproduce, modify, display, perform, sublicense and distribute the Original Code (or portions thereof) with or without Modifications, and/or as part of a Larger Work; and
- b. under Patents Claims infringed by the making, using or selling of Original Code, to make, have made, use, practice, sell, and offer for sale, and/or otherwise dispose of the Original Code (or portions thereof).
- c. the licenses granted in this Section 2.1 (a) and (b) are effective on the date Initial Developer first distributes Original Code under the terms of this License.
- d. Notwithstanding Section 2.1 (b) above, no patent license is granted: 1) for code that You delete from the Original Code; 2) separate from the Original Code; or 3) for infringements

caused by: i) the modification of the Original Code or ii) the combination of the Original Code with other software or devices.

2.2. Contributor Grant. Subject to third party intellectual property claims, each Contributor hereby grants You a world-wide, royalty-free, non-exclusive license

a. under intellectual property rights (other than patent or trademark) Licensable by Contributor, to use, reproduce, modify, display, perform, sublicense and distribute the Modifications created by such Contributor (or portions thereof) either on an unmodified basis, with other Modifications, as Covered Code and/or as part of a Larger Work; and

b. under Patent Claims infringed by the making, using, or selling of Modifications made by that Contributor either alone and/or in combination with its Contributor Version (or portions of such combination), to make, use, sell, offer for sale, have made, and/or otherwise dispose of: 1) Modifications made by that Contributor (or portions thereof); and 2) the combination of Modifications made by that Contributor with its Contributor Version (or portions of such combination).

c. the licenses granted in Sections 2.2 (a) and 2.2 (b) are effective on the date Contributor first makes Commercial Use of the Covered Code.

d. Notwithstanding Section 2.2 (b) above, no patent license is granted: 1) for any code that Contributor has deleted from the Contributor Version; 2) separate from the Contributor Version; 3) for infringements caused by: i) third party modifications of Contributor Version or ii) the combination of Modifications made by that Contributor with other software (except as part of the Contributor Version) or other devices; or 4) under Patent Claims infringed by Covered Code in the absence of Modifications made by that Contributor.

3. Distribution Obligations.

3.1. Application of License. The Modifications which You create or to which You contribute are governed by the terms of this License, including without limitation Section 2.2. The Source Code version of Covered Code may be distributed only under the terms of this License or a future version of this License released under Section 6.1, and You must include a copy of this License with every copy of the Source Code You distribute. You may not offer or impose any terms on any Source Code version that alters or restricts the applicable version of this License or the recipients' rights hereunder. However, You may include an additional document offering the additional rights described in Section 3.5.

3.2. Availability of Source Code. Any Modification which You create or to which You contribute must be made available in Source Code form under the terms of this License either on the same media as an Executable version or via an accepted Electronic Distribution Mechanism to anyone to whom you made an Executable version available; and if made available via Electronic Distribution Mechanism, must remain available for at least twelve (12) months after the date it initially became available, or at least six (6) months after a subsequent version of that particular Modification has been made available to such recipients. You are responsible for ensuring that the Source Code version remains available even if the Electronic

Distribution Mechanism is maintained by a third party.

3.3. Description of Modifications. You must cause all Covered Code to which You contribute to contain a file documenting the changes You made to create that Covered Code and the date of any change. You must include a prominent statement that the Modification is derived, directly or indirectly, from Original Code provided by the Initial Developer and including the name of the Initial Developer in (a) the Source Code, and (b) in any notice in an Executable version or related documentation in which You describe the origin or ownership of the Covered Code.

3.4. Intellectual Property Matters

(a) Third Party Claims

If Contributor has knowledge that a license under a third party's intellectual property rights is required to exercise the rights granted by such Contributor under Sections 2.1 or 2.2, Contributor must include a text file with the Source Code distribution titled "LEGAL" which describes the claim and the party making the claim in sufficient detail that a recipient will know whom to contact. If Contributor obtains such knowledge after the Modification is made available as described in Section 3.2, Contributor shall promptly modify the LEGAL file in all copies Contributor makes available thereafter and shall take other steps (such as notifying appropriate mailing lists or newsgroups) reasonably calculated to inform those who received the Covered Code that new knowledge has been obtained.

(b) Contributor APIs

If Contributor's Modifications include an application programming interface and Contributor has knowledge of patent licenses which are reasonably necessary to implement that API, Contributor must also include this information in the LEGAL file.

(c) Representations.

Contributor represents that, except as disclosed pursuant to Section 3.4 (a) above, Contributor believes that Contributor's Modifications are Contributor's original creation(s) and/or Contributor has sufficient rights to grant the rights conveyed by this License.

3.5. Required Notices. You must duplicate the notice in Exhibit A in each file of the Source Code. If it is not possible to put such notice in a particular Source Code file due to its structure, then You must include such notice in a location (such as a relevant directory) where a user would be likely to look for such a notice. If You created one or more Modification(s) You may add your name as a Contributor to the notice described in Exhibit A. You must also duplicate this License in any documentation for the Source Code where You describe recipients' rights or ownership rights relating to Covered Code. You may choose to offer, and to charge a fee for, warranty, support, indemnity or liability obligations to one or more recipients of Covered Code. However, You may do so only on Your own behalf, and not on behalf of the Initial Developer or any Contributor. You must make it absolutely clear than



any such warranty, support, indemnity or liability obligation is offered by You alone, and You hereby agree to indemnify the Initial Developer and every Contributor for any liability incurred by the Initial Developer or such Contributor as a result of warranty, support, indemnity or liability terms You offer.

3.6. Distribution of Executable Versions. You may distribute Covered Code in Executable form only if the requirements of Sections 3.1, 3.2, 3.3, 3.4 and 3.5 have been met for that Covered Code, and if You include a notice stating that the Source Code version of the Covered Code is available under the terms of this License, including a description of how and where You have fulfilled the obligations of Section 3.2. The notice must be conspicuously included in any notice in an Executable version, related documentation or collateral in which You describe recipients' rights relating to the Covered Code. You may distribute the Executable version of Covered Code or ownership rights under a license of Your choice, which may contain terms different from this License, provided that You are in compliance with the terms of this License and that the license for the Executable version does not attempt to limit or alter the recipient's rights in the Source Code version from the rights set forth in this License. If You distribute the Executable version under a different license You must make it absolutely clear that any terms which differ from this License are offered by You alone, not by the Initial Developer or any Contributor. You hereby agree to indemnify the Initial Developer and every Contributor for any liability incurred by the Initial Developer or such Contributor as a result of any such terms You offer.

3.7. Larger Works. You may create a Larger Work by combining Covered Code with other code not governed by the terms of this License and distribute the Larger Work as a single product. In such a case, You must make sure the requirements of this License are fulfilled for the Covered Code.

4. Inability to Comply Due to Statute or Regulation.

If it is impossible for You to comply with any of the terms of this License with respect to some or all of the Covered Code due to statute, judicial order, or regulation then You must: (a) comply with the terms of this License to the maximum extent possible; and (b) describe the limitations and the code they affect. Such description must be included in the LEGAL file described in Section 3.4 and must be included with all distributions of the Source Code. Except to the extent prohibited by statute or regulation, such description must be sufficiently detailed for a recipient of ordinary skill to be able to understand it.

5. Application of this License.

This License applies to code to which the Initial Developer has attached the notice in Exhibit A and to related Covered Code.

6. Versions of the License.

6.1. New Versions

Netscape Communications Corporation ("Netscape") may publish revised and/or new versions of the License from time to time. Each version will be given a distinguishing version number.

6.2. Effect of New Versions

Once Covered Code has been published under a particular version of the License, You may always continue to use it under the terms of that version. You may also choose to use such Covered Code under the terms of any subsequent version of the License published by Netscape. No one other than Netscape has the right to modify the terms applicable to Covered Code created under this License.

6.3. Derivative Works

If You create or use a modified version of this License (which you may only do in order to apply it to code which is not already Covered Code governed by this License), You must (a) rename Your license so that the phrases "Mozilla", "MOZILLAPL", "MOZPL", "Netscape", "MPL", "NPL" or any confusingly similar phrase do not appear in your license (except to note that your license differs from this License) and (b) otherwise make it clear that Your version of the license contains terms which differ from the Mozilla Public License and Netscape Public License. (Filling in the name of the Initial Developer, Original Code or Contributor in the notice described in Exhibit A shall not of themselves be deemed to be modifications of this License.)

7. DISCLAIMER OF WARRANTY

COVERED CODE IS PROVIDED UNDER THIS LICENSE ON AN "AS IS" BASIS, WITHOUT WARRANTY OF ANY KIND, EITHER EXPRESSED OR IMPLIED, INCLUDING, WITHOUT LIMITATION, WARRANTIES THAT THE COVERED CODE IS FREE OF DEFECTS, MERCHANTABILITY, FIT FOR A PARTICULAR PURPOSE OR NON-INFRINGEMENT. THE ENTIRE RISK AS TO THE QUALITY AND PERFORMANCE OF THE COVERED CODE IS WITH YOU. SHOULD ANY COVERED CODE PROVE DEFECTIVE IN ANY RESPECT, YOU (NOT THE INITIAL DEVELOPER OR ANY OTHER CONTRIBUTOR) ASSUME THE COST OF ANY NECESSARY SERVICING, REPAIR OR CORRECTION. THIS DISCLAIMER OF WARRANTY CONSTITUTES AN ESSENTIAL PART OF THIS LICENSE. NO USE OF ANY COVERED CODE IS AUTHORIZED HEREUNDER EXCEPT UNDER THIS DISCLAIMER.

8. Termination

8.1. This License and the rights granted hereunder will terminate automatically if You fail to comply with terms herein and fail to cure such breach within 30 days of becoming aware of the breach. All sublicenses to the Covered Code which are properly granted shall survive any termination of this License. Provisions which, by their nature, must remain in effect beyond the termination of this License shall survive.

8.2. If You initiate litigation by asserting a patent infringement claim (excluding declaratory judgment actions) against Initial Developer or a Contributor (the Initial Developer or

Contributor against whom You file such action is referred to as "Participant") alleging that:

a. such Participant's Contributor Version directly or indirectly infringes any patent, then any and all rights granted by such Participant to You under Sections 2.1 and/or 2.2 of this License shall, upon 60 days notice from Participant terminate prospectively, unless if within 60 days after receipt of notice You either: (i) agree in writing to pay Participant a mutually agreeable reasonable royalty for Your past and future use of Modifications made by such Participant, or (ii) withdraw Your litigation claim with respect to the Contributor Version against such Participant. If within 60 days of notice, a reasonable royalty and payment arrangement are not mutually agreed upon in writing by the parties or the litigation claim is not withdrawn, the rights granted by Participant to You under Sections 2.1 and/or 2.2 automatically terminate at the expiration of the 60 day notice period specified above.

b. any software, hardware, or device, other than such Participant's Contributor Version, directly or indirectly infringes any patent, then any rights granted to You by such Participant under Sections 2.1(b) and 2.2(b) are revoked effective as of the date You first made, used, sold, distributed, or had made, Modifications made by that Participant.

8.3. If You assert a patent infringement claim against Participant alleging that such Participant's Contributor Version directly or indirectly infringes any patent where such claim is resolved (such as by license or settlement) prior to the initiation of patent infringement litigation, then the reasonable value of the licenses granted by such Participant under Sections 2.1 or 2.2 shall be taken into account in determining the amount or value of any payment or license.

8.4. In the event of termination under Sections 8.1 or 8.2 above, all end user license agreements (excluding distributors and resellers) which have been validly granted by You or any distributor hereunder prior to termination shall survive termination.

9. LIMITATION OF LIABILITY

UNDER NO CIRCUMSTANCES AND UNDER NO LEGAL THEORY, WHETHER TORT (INCLUDING NEGLIGENCE), CONTRACT, OR OTHERWISE, SHALL YOU, THE INITIAL DEVELOPER, ANY OTHER CONTRIBUTOR, OR ANY DISTRIBUTOR OF COVERED CODE, OR ANY SUPPLIER OF ANY OF SUCH PARTIES, BE LIABLE TO ANY PERSON FOR ANY INDIRECT, SPECIAL, INCIDENTAL, OR CONSEQUENTIAL DAMAGES OF ANY CHARACTER INCLUDING, WITHOUT LIMITATION, DAMAGES FOR LOSS OF GOODWILL, WORK STOPPAGE, COMPUTER FAILURE OR MALFUNCTION, OR ANY AND ALL OTHER COMMERCIAL DAMAGES OR LOSSES, EVEN IF SUCH PARTY SHALL HAVE BEEN INFORMED OF THE POSSIBILITY OF SUCH DAMAGES. THIS LIMITATION OF LIABILITY SHALL NOT APPLY TO LIABILITY FOR DEATH OR PERSONAL INJURY RESULTING FROM SUCH PARTY'S NEGLIGENCE TO THE EXTENT APPLICABLE LAW PROHIBITS SUCH LIMITATION. SOME JURISDICTIONS DO NOT ALLOW THE EXCLUSION OR LIMITATION OF INCIDENTAL OR CONSEQUENTIAL DAMAGES, SO THIS EXCLUSION AND LIMITATION MAY NOT APPLY TO YOU.

10. U.S. government end users



The Covered Code is a "commercial item," as that term is defined in 48 C.F.R. 2.101 (Oct. 1995), consisting of "commercial computer software" and "commercial computer software documentation," as such terms are used in 48 C.F.R. 12.212 (Sept. 1995). Consistent with 48 C.F.R. 12.212 and 48 C.F.R. 227.7202-1 through 227.7202-4 (June 1995), all U.S. Government End Users acquire Covered Code with only those rights set forth herein.

11. Miscellaneous

This License represents the complete agreement concerning subject matter hereof. If any provision of this License is held to be unenforceable, such provision shall be reformed only to the extent necessary to make it enforceable. This License shall be governed by California law provisions (except to the extent applicable law, if any, provides otherwise), excluding its conflict-of-law provisions. With respect to disputes in which at least one party is a citizen of, or an entity chartered or registered to do business in the United States of America, any litigation relating to this License shall be subject to the jurisdiction of the Federal Courts of the Northern District of California, with venue lying in Santa Clara County, California, with the losing party responsible for costs, including without limitation, court costs and reasonable attorneys' fees and expenses. The application of the United Nations Convention on Contracts for the International Sale of Goods is expressly excluded. Any law or regulation which provides that the language of a contract shall be construed against the drafter shall not apply to this License.

12. Responsibility for claims

As between Initial Developer and the Contributors, each party is responsible for claims and damages arising, directly or indirectly, out of its utilization of rights under this License and You agree to work with Initial Developer and Contributors to distribute such responsibility on an equitable basis. Nothing herein is intended or shall be deemed to constitute any admission of liability.

13. Multiple-licensed code

Initial Developer may designate portions of the Covered Code as "Multiple-Licensed". "Multiple-Licensed" means that the Initial Developer permits you to utilize portions of the Covered Code under Your choice of the MPL or the alternative licenses, if any, specified by the Initial Developer in the file described in Exhibit A.

Exhibit A - Mozilla Public License.

"The contents of this file are subject to the Mozilla Public License Version 1.1 (the "License"); you may not use this file except in compliance with the License. You may obtain a copy of the License at <http://www.mozilla.org/MPL/>

Software distributed under the License is distributed on an "AS IS" basis, WITHOUT WARRANTY OF ANY KIND, either express or implied. See the License for the specific language governing rights and limitations under the License.



The Original Code is _____.

The Initial Developer of the Original Code is _____.

Portions created by _____ are Copyright (C) _____
_____. All Rights Reserved.

Contributor(s): _____.

Alternatively, the contents of this file may be used under the terms of the ____ license (the "[] License"), in which case the provisions of [] License are applicable instead of those above. If you wish to allow use of your version of this file only under the terms of the [] License and not to allow others to use your version of this file under the MPL, indicate your decision by deleting the provisions above and replace them with the notice and other provisions required by the [] License. If you do not delete the provisions above, a recipient may use your version of this file under either the MPL or the [] License."

NOTE: The text of this Exhibit A may differ slightly from the text of the notices in the Source Code files of the Original Code. You should use the text of this Exhibit A rather than the text found in the Original Code Source Code for Your Modifications.

MPL-2.0

Mozilla Public License Version 2.0

1. Definitions

1.1. "Contributor" means each individual or legal entity that creates, contributes to the creation of, or owns Covered Software.

1.2. "Contributor Version" means the combination of the Contributions of others (if any) used by a Contributor and that particular Contributor's Contribution.

1.3. "Contribution" means Covered Software of a particular Contributor.

1.4. "Covered Software" means Source Code Form to which the initial Contributor has attached the notice in Exhibit A, the Executable Form of such Source Code Form, and Modifications of such Source Code Form, in each case including portions thereof.

1.5. "Incompatible With Secondary Licenses" means

(a) that the initial Contributor has attached the notice described in Exhibit B to the Covered Software; or

(b) that the Covered Software was made available under the terms of version 1.1 or earlier of the License, but not also under the terms of a Secondary License.

1.6. "Executable Form" means any form of the work other than Source Code Form.

1.7. "Larger Work" means a work that combines Covered Software with other material, in a separate file or files, that is not Covered Software.

1.8. "License" means this document.

1.9. "Licensable" means having the right to grant, to the maximum extent possible, whether at the time of the initial grant or subsequently, any and all of the rights conveyed by this License.

1.10. "Modifications" means any of the following:

(a) any file in Source Code Form that results from an addition to, deletion from, or modification of the contents of Covered Software; or

(b) any new file in Source Code Form that contains any Covered Software.

1.11. "Patent Claims" of a Contributor means any patent claim(s), including without limitation, method, process, and apparatus claims, in any patent Licensable by such Contributor that would be infringed, but for the grant of the License, by the making, using, selling, offering for sale, having made, import, or transfer of either its Contributions or its Contributor Version.

1.12. "Secondary License" means either the GNU General Public License, Version 2.0, the GNU Lesser General Public License, Version 2.1, the GNU Affero General Public License, Version 3.0, or any later versions of those licenses.

1.13. "Source Code Form" means the form of the work preferred for making modifications.

1.14. "You" (or "Your") means an individual or a legal entity exercising rights under this License. For legal entities, "You" includes any entity that controls, is controlled by, or is under common control with You. For purposes of this definition, "control" means (a) the power, direct or indirect, to cause the direction or management of such entity, whether by contract or otherwise, or (b) ownership of more than fifty percent (50%) of the outstanding shares or beneficial ownership of such entity.

2. License Grants and Conditions

2.1. Grants

Each Contributor hereby grants You a world-wide, royalty-free, non-exclusive license:

(a) under intellectual property rights (other than patent or trademark) Licensable by such Contributor to use, reproduce, make available, modify, display, perform, distribute, and otherwise exploit its Contributions, either on an unmodified basis, with Modifications, or as part of a Larger Work; and

(b) under Patent Claims of such Contributor to make, use, sell, offer for sale, have made, import, and otherwise transfer either its Contributions or its Contributor Version.

2.2. Effective Date

The licenses granted in Section 2.1 with respect to any Contribution become effective for each Contribution on the date the Contributor first distributes such Contribution.

2.3. Limitations on Grant Scope

The licenses granted in this Section 2 are the only rights granted under this License. No additional rights or licenses will be implied from the distribution or licensing of Covered Software under this License. Notwithstanding Section 2.1(b) above, no patent license is granted by a Contributor:

(a) for any code that a Contributor has removed from Covered Software; or

(b) for infringements caused by: (i) Your and any other third party's modifications of Covered Software, or (ii) the combination of its Contributions with other software (except as part of its Contributor Version); or

(c) under Patent Claims infringed by Covered Software in the absence of its Contributions.

This License does not grant any rights in the trademarks, service marks, or logos of any Contributor (except as may be necessary to comply with the notice requirements in Section 3.4).

2.4. Subsequent Licenses

No Contributor makes additional grants as a result of Your choice to distribute the Covered Software under a subsequent version of this License (see Section 10.2) or under the terms of a Secondary License (if permitted under the terms of Section 3.3).

2.5. Representation

Each Contributor represents that the Contributor believes its Contributions are its original creation(s) or it has sufficient rights to grant the rights to its Contributions conveyed by this License.

2.6. Fair Use

This License is not intended to limit any rights You have under applicable copyright doctrines of fair use, fair dealing, or other equivalents.

2.7. Conditions

Sections 3.1, 3.2, 3.3, and 3.4 are conditions of the licenses granted in Section 2.1.

3. Responsibilities

3.1. Distribution of Source Form

All distribution of Covered Software in Source Code Form, including any Modifications that You create or to which You contribute, must be under the terms of this License. You must inform recipients that the Source Code Form of the Covered Software is governed by the terms of this License, and how they can obtain a copy of this License. You may not attempt to alter or restrict the recipients' rights in the Source Code Form.

3.2. Distribution of Executable Form

If You distribute Covered Software in Executable Form then:

(a) such Covered Software must also be made available in Source Code Form, as described in Section 3.1, and You must inform recipients of the Executable Form how they can obtain a copy of such Source Code Form by reasonable means in a timely manner, at a charge no more than the cost of distribution to the recipient; and

(b) You may distribute such Executable Form under the terms of this License, or sublicense it under different terms, provided that the license for the Executable Form does not attempt to limit or alter the recipients' rights in the Source Code Form under this License.

3.3. Distribution of a Larger Work

You may create and distribute a Larger Work under terms of Your choice, provided that You also comply with the requirements of this License for the Covered Software. If the Larger Work is a combination of Covered Software with a work governed by one or more Secondary Licenses, and the Covered Software is not Incompatible With Secondary Licenses, this License permits You to additionally distribute such Covered Software under the terms of such Secondary License(s), so that the recipient of the Larger Work may, at their option, further

distribute the Covered Software under the terms of either this License or such Secondary License(s).

3.4. Notices

You may not remove or alter the substance of any license notices (including copyright notices, patent notices, disclaimers of warranty, or limitations of liability) contained within the Source Code Form of the Covered Software, except that You may alter any license notices to the extent required to remedy known factual inaccuracies.

3.5. Application of Additional Terms

You may choose to offer, and to charge a fee for, warranty, support, indemnity or liability obligations to one or more recipients of Covered Software. However, You may do so only on Your own behalf, and not on behalf of any Contributor. You must make it absolutely clear that any such warranty, support, indemnity, or liability obligation is offered by You alone, and You hereby agree to indemnify every Contributor for any liability incurred by such Contributor as a result of warranty, support, indemnity or liability terms You offer. You may include additional disclaimers of warranty and limitations of liability specific to any jurisdiction.

4. Inability to Comply Due to Statute or Regulation

If it is impossible for You to comply with any of the terms of this License with respect to some or all of the Covered Software due to statute, judicial order, or regulation then You must: (a) comply with the terms of this License to the maximum extent possible; and (b) describe the limitations and the code they affect. Such description must be placed in a text file included with all distributions of the Covered Software under this License. Except to the extent prohibited by statute or regulation, such description must be sufficiently detailed for a recipient of ordinary skill to be able to understand it.

5. Termination

5.1. The rights granted under this License will terminate automatically if You fail to comply with any of its terms. However, if You become compliant, then the rights granted under this License from a particular Contributor are reinstated (a) provisionally, unless and until such Contributor explicitly and finally terminates Your grants, and (b) on an ongoing basis, if such Contributor fails to notify You of the non-compliance by some reasonable means prior to 60 days after You have come back into compliance. Moreover, Your grants from a particular Contributor are reinstated on an ongoing basis if such Contributor notifies You of the non-compliance by some reasonable means, this is the first time You have received notice of non-compliance with this License from such Contributor, and You become compliant prior to 30 days after Your receipt of the notice.

5.2. If You initiate litigation against any entity by asserting a patent infringement claim (excluding declaratory judgment actions, counter-claims, and cross-claims) alleging that a Contributor Version directly or indirectly infringes any patent, then the rights granted to You

by any and all Contributors for the Covered Software under Section 2.1 of this License shall terminate.

5.3. In the event of termination under Sections 5.1 or 5.2 above, all end user license agreements (excluding distributors and resellers) which have been validly granted by You or Your distributors under this License prior to termination shall survive termination.

6. Disclaimer of Warranty

Covered Software is provided under this License on an "as is" basis, without warranty of any kind, either expressed, implied, or statutory, including, without limitation, warranties that the Covered Software is free of defects, merchantable, fit for a particular purpose or non-infringing. The entire risk as to the quality and performance of the Covered Software is with You. Should any Covered Software prove defective in any respect, You (not any Contributor) assume the cost of any necessary servicing, repair, or correction. This disclaimer of warranty constitutes an essential part of this License. No use of any Covered Software is authorized under this License except under this disclaimer.

7. Limitation of Liability

Under no circumstances and under no legal theory, whether tort (including negligence), contract, or otherwise, shall any Contributor, or anyone who distributes Covered Software as permitted above, be liable to You for any direct, indirect, special, incidental, or consequential damages of any character including, without limitation, damages for lost profits, loss of goodwill, work stoppage, computer failure or malfunction, or any and all other commercial damages or losses, even if such party shall have been informed of the possibility of such damages. This limitation of liability shall not apply to liability for death or personal injury resulting from such party's negligence to the extent applicable law prohibits such limitation. Some jurisdictions do not allow the exclusion or limitation of incidental or consequential damages, so this exclusion and limitation may not apply to You.

8. Litigation

Any litigation relating to this License may be brought only in the courts of a jurisdiction where the defendant maintains its principal place of business and such litigation shall be governed by laws of that jurisdiction, without reference to its conflict-of-law provisions. Nothing in this Section shall prevent a party's ability to bring cross-claims or counter-claims.

9. Miscellaneous

This License represents the complete agreement concerning the subject matter hereof. If any provision of this License is held to be unenforceable, such provision shall be reformed only to the extent necessary to make it enforceable. Any law or regulation which provides that the language of a contract shall be construed against the drafter shall not be used to construe this License against a Contributor.

10. Versions of the License

10.1. New Versions

Mozilla Foundation is the license steward. Except as provided in Section 10.3, no one other than the license steward has the right to modify or publish new versions of this License. Each version will be given a distinguishing version number.

10.2. Effect of New Versions

You may distribute the Covered Software under the terms of the version of the License under which You originally received the Covered Software, or under the terms of any subsequent version published by the license steward.

10.3. Modified Versions

If you create software not governed by this License, and you want to create a new license for such software, you may create and use a modified version of this License if you rename the license and remove any references to the name of the license steward (except to note that such modified license differs from this License).

10.4. Distributing Source Code Form that is Incompatible With Secondary Licenses

If You choose to distribute Source Code Form that is Incompatible With Secondary Licenses under the terms of this version of the License, the notice described in Exhibit B of this License must be attached.

Exhibit A - Source Code Form License Notice

This Source Code Form is subject to the terms of the Mozilla Public License, v. 2.0. If a copy of the MPL was not distributed with this file, You can obtain one at <http://mozilla.org/MPL/2.0/>.

If it is not possible or desirable to put the notice in a particular file, then You may include the notice in a location (such as a LICENSE file in a relevant directory) where a recipient would be likely to look for such a notice.

You may add additional accurate notices of copyright ownership.

Exhibit B - "Incompatible With Secondary Licenses" Notice

This Source Code Form is "Incompatible With Secondary Licenses", as defined by the Mozilla Public License, v. 2.0.

NCSA



University of Illinois/NCSA Open Source License

Copyright (c) <Year> <Owner Organization Name>. All rights reserved.

Developed by: <Name of Development Group> <Name of Institution> <URL for Development Group/Institution>

Permission is hereby granted, free of charge, to any person obtaining a copy of this software and associated documentation files (the "Software"), to deal with the Software without restriction, including without limitation the rights to use, copy, modify, merge, publish, distribute, sublicense, and/or sell copies of the Software, and to permit persons to whom the Software is furnished to do so, subject to the following conditions:

* Redistributions of source code must retain the above copyright notice, this list of conditions and the following disclaimers.

* Redistributions in binary form must reproduce the above copyright notice, this list of conditions and the following disclaimers in the documentation and/or other materials provided with the distribution.

* Neither the names of <Name of Development Group, Name of Institution>, nor the names of its contributors may be used to endorse or promote products derived from this Software without specific prior written permission.

THE SOFTWARE IS PROVIDED "AS IS", WITHOUT WARRANTY OF ANY KIND, EXPRESS OR IMPLIED, INCLUDING BUT NOT LIMITED TO THE WARRANTIES OF MERCHANTABILITY, FITNESS FOR A PARTICULAR PURPOSE AND NONINFRINGEMENT. IN NO EVENT SHALL THE CONTRIBUTORS OR COPYRIGHT HOLDERS BE LIABLE FOR ANY CLAIM, DAMAGES OR OTHER LIABILITY, WHETHER IN AN ACTION OF CONTRACT, TORT OR OTHERWISE, ARISING FROM, OUT OF OR IN CONNECTION WITH THE SOFTWARE OR THE USE OR OTHER DEALINGS WITH THE SOFTWARE.

NICTA Public Software Licence 1.0

NICTA Public Software Licence

Version 1.0

Copyright © 2004 National ICT Australia Ltd

All rights reserved.

By this licence, National ICT Australia Ltd (NICTA) grants permission, free of charge, to any

person who obtains a copy of this software and any associated documentation files ("the Software") to use and deal with the Software in source code and binary forms without restriction, with or without modification, and to permit persons to whom the Software is furnished to do so, provided that the following conditions are met:

- Redistributions of source code must retain the above copyright notice, this list of conditions and the following disclaimers.
- Redistributions in binary form must reproduce the above copyright notice, this list of conditions and the following disclaimers in the documentation and/or other materials provided with the distribution.
- The name of NICTA may not be used to endorse or promote products derived from this Software without specific prior written permission.

EXCEPT AS EXPRESSLY STATED IN THIS LICENCE AND TO THE FULL EXTENT PERMITTED BY APPLICABLE LAW, THE SOFTWARE IS PROVIDED "AS-IS" AND NICTA MAKES NO REPRESENTATIONS, WARRANTIES OR CONDITIONS OF ANY KIND, EXPRESS OR IMPLIED, INCLUDING, WITHOUT LIMITATION, ANY REPRESENTATIONS, WARRANTIES OR CONDITIONS REGARDING THE CONTENTS OR ACCURACY OF THE SOFTWARE, OR OF TITLE, MERCHANTABILITY, FITNESS FOR A PARTICULAR PURPOSE, NONINFRINGEMENT, THE ABSENCE OF LATENT OR OTHER DEFECTS, OR THE PRESENCE OR ABSENCE OF ERRORS, WHETHER OR NOT DISCOVERABLE.

TO THE FULL EXTENT PERMITTED BY APPLICABLE LAW, IN NO EVENT WILL NICTA BE LIABLE ON ANY LEGAL THEORY (INCLUDING, WITHOUT LIMITATION, NEGLIGENCE) FOR ANY LOSS OR DAMAGE WHATSOEVER, INCLUDING (WITHOUT LIMITATION) LOSS OF PRODUCTION OR OPERATION TIME, LOSS, DAMAGE OR CORRUPTION OF DATA OR RECORDS; OR LOSS OF ANTICIPATED SAVINGS, OPPORTUNITY, REVENUE, PROFIT OR GOODWILL, OR OTHER ECONOMIC LOSS; OR ANY SPECIAL, INCIDENTAL, INDIRECT, CONSEQUENTIAL, PUNITIVE OR EXEMPLARY DAMAGES ARISING OUT OF OR IN CONNECTION WITH THIS LICENCE, THE SOFTWARE OR THE USE OF THE SOFTWARE, EVEN IF NICTA HAS BEEN ADVISED OF THE POSSIBILITY OF SUCH DAMAGES.

If applicable legislation implies warranties or conditions, or imposes obligations or liability on NICTA in respect of the Software that cannot be wholly or partly excluded, restricted or modified, NICTA's liability is limited, to the full extent permitted by the applicable legislation, at its option, to:

- a. in the case of goods, any one or more of the following:
 - i. the replacement of the goods or the supply of equivalent goods;
 - ii. the repair of the goods;
 - iii. the payment of the cost of replacing the goods or of acquiring equivalent goods;
 - iv. the payment of the cost of having the goods repaired; or
- b. in the case of services:
 - i. the supplying of the services again; or

ii. the payment of the cost of having the services supplied again.

NTP

NTP License (NTP)

Copyright (c) (CopyrightHoldersName) (From 4-digit-year)-(To 4-digit-year)

Permission to use, copy, modify, and distribute this software and its documentation for any purpose with or without fee is hereby granted, provided that the above copyright notice appears in all copies and that both the copyright notice and this permission notice appear in supporting documentation, and that the name (TrademarkedName) not be used in advertising or publicity pertaining to distribution of the software without specific, written prior permission. (TrademarkedName) makes no representations about the suitability this software for any purpose. It is provided "as is" without express or implied warranty.

OpenSSH License

The licences which components of this software fall under are as follows. First, we will summarize and say that all components are under a BSD licence, or a licence more free than that.

OpenSSH contains no GPL code.

1)

* Copyright (c) 1995 Tatu Ylonen <ylo@cs.hut.fi>, Espoo, Finland

* All rights reserved

*

* As far as I am concerned, the code I have written for this software

* can be used freely for any purpose. Any derived versions of this

* software must be clearly marked as such, and if the derived work is

* incompatible with the protocol description in the RFC file, it must be

* called by a name other than "ssh" or "Secure Shell".

[Tatu continues]

* However, I am not implying to give any licenses to any patents or

* copyrights held by third parties, and the software includes parts that

* are not under my direct control. As far as I know, all included

- * source code is used in accordance with the relevant license agreements
- * and can be used freely for any purpose (the GNU license being the most
- * restrictive); see below for details.

[However, none of that term is relevant at this point in time. All of these restrictively licenced software components which he talks about have been removed from OpenSSH, i.e.,

- RSA is no longer included, found in the OpenSSL library
- IDEA is no longer included, its use is deprecated
- DES is now external, in the OpenSSL library
- GMP is no longer used, and instead we call BN code from OpenSSL
- Zlib is now external, in a library
- The make-ssh-known-hosts script is no longer included
- TSS has been removed
- MD5 is now external, in the OpenSSL library
- RC4 support has been replaced with ARC4 support from OpenSSL
- Blowfish is now external, in the OpenSSL library

[The licence continues]

Note that any information and cryptographic algorithms used in this software are publicly available on the Internet and at any major bookstore, scientific library, and patent office worldwide. More information can be found e.g. at "<http://www.cs.hut.fi/crypto>".

The legal status of this program is some combination of all these permissions and restrictions. Use only at your own responsibility. You will be responsible for any legal consequences yourself; I am not making any claims whether possessing or using this is legal or not in your country, and I am not taking any responsibility on your behalf.

NO WARRANTY

BECAUSE THE PROGRAM IS LICENSED FREE OF CHARGE, THERE IS NO WARRANTY FOR THE PROGRAM, TO THE EXTENT PERMITTED BY APPLICABLE LAW. EXCEPT WHEN OTHERWISE STATED IN WRITING THE COPYRIGHT HOLDERS AND/OR OTHER PARTIES

PROVIDE THE PROGRAM "AS IS" WITHOUT WARRANTY OF ANY KIND, EITHER EXPRESSED OR IMPLIED, INCLUDING, BUT NOT LIMITED TO, THE IMPLIED WARRANTIES OF MERCHANTABILITY AND FITNESS FOR A PARTICULAR PURPOSE. THE ENTIRE RISK AS TO THE QUALITY AND PERFORMANCE OF THE PROGRAM IS WITH YOU. SHOULD THE PROGRAM PROVE DEFECTIVE, YOU ASSUME THE COST OF ALL NECESSARY SERVICING, REPAIR OR CORRECTION.

IN NO EVENT UNLESS REQUIRED BY APPLICABLE LAW OR AGREED TO IN WRITING WILL ANY COPYRIGHT HOLDER, OR ANY OTHER PARTY WHO MAY MODIFY AND/OR REDISTRIBUTE THE PROGRAM AS PERMITTED ABOVE, BE LIABLE TO YOU FOR DAMAGES, INCLUDING ANY GENERAL, SPECIAL, INCIDENTAL OR CONSEQUENTIAL DAMAGES ARISING OUT OF THE USE OR INABILITY TO USE THE PROGRAM (INCLUDING BUT NOT LIMITED TO LOSS OF DATA OR DATA BEING RENDERED INACCURATE OR LOSSES SUSTAINED BY YOU OR THIRD PARTIES OR A FAILURE OF THE PROGRAM TO OPERATE WITH ANY OTHER PROGRAMS), EVEN IF SUCH HOLDER OR OTHER PARTY HAS BEEN ADVISED OF THE POSSIBILITY OF SUCH DAMAGES.

2)

The 32-bit CRC compensation attack detector in deattack.c was contributed by CORE SDI S.A. under a BSD-style license.

* Cryptographic attack detector for ssh - source code

*

* Copyright (c) 1998 CORE SDI S.A., Buenos Aires, Argentina.

*

* All rights reserved. Redistribution and use in source and binary forms, with or without modification, are permitted provided that this copyright notice is retained.

*

* THIS SOFTWARE IS PROVIDED ``AS IS" AND ANY EXPRESS OR IMPLIED WARRANTIES ARE DISCLAIMED. IN NO EVENT SHALL CORE SDI S.A. BE LIABLE FOR ANY DIRECT, INDIRECT, INCIDENTAL, SPECIAL, EXEMPLARY OR CONSEQUENTIAL DAMAGES RESULTING FROM THE USE OR MISUSE OF THIS SOFTWARE.

*

* Ariel Futoransky <futo@core-sdi.com>

* <<http://www.core-sdi.com>>

3)

ssh-keyscan was contributed by David Mazieres under a BSD-style license.

* Copyright 1995, 1996 by David Mazieres <dm@lcs.mit.edu>.

*

* Modification and redistribution in source and binary forms is

* permitted provided that due credit is given to the author and the

* OpenBSD project by leaving this copyright notice intact.

4)

The Rijndael implementation by Vincent Rijmen, Antoon Bosselaers and Paulo Barreto is in the public domain and distributed with the following license:

* @version 3.0 (December 2000)

*

* Optimised ANSI C code for the Rijndael cipher (now AES)

*

* @author Vincent Rijmen <vincent.rijmen@esat.kuleuven.ac.be>

* @author Antoon Bosselaers <antoon.bosselaers@esat.kuleuven.ac.be>

* @author Paulo Barreto <paulo.barreto@terra.com.br>

*

* This code is hereby placed in the public domain.

*

* THIS SOFTWARE IS PROVIDED BY THE AUTHORS "AS IS" AND ANY EXPRESS
* OR IMPLIED WARRANTIES, INCLUDING, BUT NOT LIMITED TO, THE IMPLIED
* WARRANTIES OF MERCHANTABILITY AND FITNESS FOR A PARTICULAR PURPOSE
* ARE DISCLAIMED. IN NO EVENT SHALL THE AUTHORS OR CONTRIBUTORS BE
* LIABLE FOR ANY DIRECT, INDIRECT, INCIDENTAL, SPECIAL, EXEMPLARY, OR
* CONSEQUENTIAL DAMAGES (INCLUDING, BUT NOT LIMITED TO, PROCUREMENT OF
* SUBSTITUTE GOODS OR SERVICES; LOSS OF USE, DATA, OR PROFITS; OR
* BUSINESS INTERRUPTION) HOWEVER CAUSED AND ON ANY THEORY OF LIABILITY,
* WHETHER IN CONTRACT, STRICT LIABILITY, OR TORT (INCLUDING NEGLIGENCE
* OR OTHERWISE) ARISING IN ANY WAY OUT OF THE USE OF THIS SOFTWARE,
* EVEN IF ADVISED OF THE POSSIBILITY OF SUCH DAMAGE.

5)

One component of the ssh source code is under a 3-clause BSD license, held by the University of California, since we pulled these parts from original Berkeley code.

* Copyright (c) 1983, 1990, 1992, 1993, 1995

* The Regents of the University of California. All rights reserved.

*

* Redistribution and use in source and binary forms, with or without
* modification, are permitted provided that the following conditions
* are met:

* 1. Redistributions of source code must retain the above copyright
* notice, this list of conditions and the following disclaimer.

* 2. Redistributions in binary form must reproduce the above copyright
* notice, this list of conditions and the following disclaimer in the
* documentation and/or other materials provided with the distribution.

* 3. Neither the name of the University nor the names of its contributors
* may be used to endorse or promote products derived from this software
* without specific prior written permission.

*

* THIS SOFTWARE IS PROVIDED BY THE REGENTS AND CONTRIBUTORS ``AS IS'' AND
* ANY EXPRESS OR IMPLIED WARRANTIES, INCLUDING, BUT NOT LIMITED TO, THE
* IMPLIED WARRANTIES OF MERCHANTABILITY AND FITNESS FOR A PARTICULAR PURPOSE
* ARE DISCLAIMED. IN NO EVENT SHALL THE REGENTS OR CONTRIBUTORS BE LIABLE
* FOR ANY DIRECT, INDIRECT, INCIDENTAL, SPECIAL, EXEMPLARY, OR CONSEQUENTIAL
* DAMAGES (INCLUDING, BUT NOT LIMITED TO, PROCUREMENT OF SUBSTITUTE GOODS
* OR SERVICES; LOSS OF USE, DATA, OR PROFITS; OR BUSINESS INTERRUPTION)
* HOWEVER CAUSED AND ON ANY THEORY OF LIABILITY, WHETHER IN CONTRACT, STRICT
* LIABILITY, OR TORT (INCLUDING NEGLIGENCE OR OTHERWISE) ARISING IN ANY WAY
* OUT OF THE USE OF THIS SOFTWARE, EVEN IF ADVISED OF THE POSSIBILITY OF
* SUCH DAMAGE.

6)

Remaining components of the software are provided under a standard 2-term BSD licence with the following names as copyright holders:



Markus Friedl
Theo de Raadt
Niels Provos
Dug Song
Aaron Campbell
Damien Miller
Kevin Steves
Daniel Kouril
Wesley Griffin
Per Allansson
Nils Nordman
Simon Wilkinson

Redistribution and use in source and binary forms, with or without modification, are permitted provided that the following conditions are met:

1. Redistributions of source code must retain the above copyright notice, this list of conditions and the following disclaimer.
2. Redistributions in binary form must reproduce the above copyright notice, this list of conditions and the following disclaimer in the documentation and/or other materials provided with the distribution.

*

* THIS SOFTWARE IS PROVIDED BY THE AUTHOR ``AS IS'' AND ANY EXPRESS OR
* IMPLIED WARRANTIES, INCLUDING, BUT NOT LIMITED TO, THE IMPLIED WARRANTIES
* OF MERCHANTABILITY AND FITNESS FOR A PARTICULAR PURPOSE ARE DISCLAIMED.
* IN NO EVENT SHALL THE AUTHOR BE LIABLE FOR ANY DIRECT, INDIRECT,
* INCIDENTAL, SPECIAL, EXEMPLARY, OR CONSEQUENTIAL DAMAGES (INCLUDING, BUT
* NOT LIMITED TO, PROCUREMENT OF SUBSTITUTE GOODS OR SERVICES; LOSS OF USE,
* DATA, OR PROFITS; OR BUSINESS INTERRUPTION) HOWEVER CAUSED AND ON ANY
* THEORY OF LIABILITY, WHETHER IN CONTRACT, STRICT LIABILITY, OR TORT
* (INCLUDING NEGLIGENCE OR OTHERWISE) ARISING IN ANY WAY OUT OF THE USE OF
* THIS SOFTWARE, EVEN IF ADVISED OF THE POSSIBILITY OF SUCH DAMAGE.

OpenSSL

OpenSSL License

Copyright (c) 1998-2008 The OpenSSL Project. All rights reserved.

Redistribution and use in source and binary forms, with or without modification, are permitted provided that the following conditions are met:

1. Redistributions of source code must retain the above copyright notice, this list of conditions and the following disclaimer.
2. Redistributions in binary form must reproduce the above copyright notice, this list of conditions and the following disclaimer in the documentation and/or other materials provided with the distribution.
3. All advertising materials mentioning features or use of this software must display the following acknowledgment: "This product includes software developed by the OpenSSL Project for use in the OpenSSL Toolkit. (<http://www.openssl.org/>)"
4. The names "OpenSSL Toolkit" and "OpenSSL Project" must not be used to endorse or promote products derived from this software without prior written permission. For written permission, please contact openssl-core@openssl.org.
5. Products derived from this software may not be called "OpenSSL" nor may "OpenSSL" appear in their names without prior written permission of the OpenSSL Project.
6. Redistributions of any form whatsoever must retain the following acknowledgment: "This product includes software developed by the OpenSSL Project for use in the OpenSSL Toolkit (<http://www.openssl.org/>)"

THIS SOFTWARE IS PROVIDED BY THE OpenSSL PROJECT ``AS IS'' AND ANY EXPRESSED OR IMPLIED WARRANTIES, INCLUDING, BUT NOT LIMITED TO, THE IMPLIED WARRANTIES OF MERCHANTABILITY AND FITNESS FOR A PARTICULAR PURPOSE ARE DISCLAIMED. IN NO EVENT SHALL THE OpenSSL PROJECT OR ITS CONTRIBUTORS BE LIABLE FOR ANY DIRECT, INDIRECT, INCIDENTAL, SPECIAL, EXEMPLARY, OR CONSEQUENTIAL DAMAGES (INCLUDING, BUT NOT LIMITED TO, PROCUREMENT OF SUBSTITUTE GOODS OR SERVICES; LOSS OF USE, DATA, OR PROFITS; OR BUSINESS INTERRUPTION) HOWEVER CAUSED AND ON ANY THEORY OF LIABILITY, WHETHER IN CONTRACT, STRICT LIABILITY, OR TORT (INCLUDING NEGLIGENCE OR OTHERWISE) ARISING IN ANY WAY OUT OF THE USE OF THIS SOFTWARE, EVEN IF ADVISED OF THE POSSIBILITY OF SUCH DAMAGE.

This product includes cryptographic software written by Eric Young (eay@cryptsoft.com). This product includes software written by Tim Hudson (tjh@cryptsoft.com).

Original SSLeay License

Copyright (C) 1995-1998 Eric Young (eay@cryptsoft.com) All rights reserved.

This package is an SSL implementation written by Eric Young (eay@cryptsoft.com). The implementation was written so as to conform with Netscapes SSL.

This library is free for commercial and non-commercial use as long as the following conditions are adhered to. The following conditions apply to all code found in this distribution, be it the RC4, RSA, lhash, DES, etc., code; not just the SSL code. The SSL documentation included with this distribution is covered by the same copyright terms except that the holder is Tim Hudson (tjh@cryptsoft.com).

Copyright remains Eric Young's, and as such any Copyright notices in the code are not to be removed. If this package is used in a product, Eric Young should be given attribution as the author of the parts of the library used. This can be in the form of a textual message at program startup or in documentation (online or textual) provided with the package.

Redistribution and use in source and binary forms, with or without modification, are permitted provided that the following conditions are met:

1. Redistributions of source code must retain the copyright notice, this list of conditions and the following disclaimer.
2. Redistributions in binary form must reproduce the above copyright notice, this list of conditions and the following disclaimer in the documentation and/or other materials provided with the distribution.
3. All advertising materials mentioning features or use of this software must display the following acknowledgement:
"This product includes cryptographic software written by Eric Young (eay@cryptsoft.com)"
The word 'cryptographic' can be left out if the routines from the library being used are not cryptographic related :-).
4. If you include any Windows specific code (or a derivative thereof) from the apps directory (application code) you must include an acknowledgement: "This product includes software written by Tim Hudson (tjh@cryptsoft.com)"

THIS SOFTWARE IS PROVIDED BY ERIC YOUNG ``AS IS'' AND ANY EXPRESS OR IMPLIED WARRANTIES, INCLUDING, BUT NOT LIMITED TO, THE IMPLIED WARRANTIES OF MERCHANTABILITY AND FITNESS FOR A PARTICULAR PURPOSE ARE DISCLAIMED. IN NO EVENT SHALL THE AUTHOR OR CONTRIBUTORS BE LIABLE FOR ANY DIRECT, INDIRECT, INCIDENTAL, SPECIAL, EXEMPLARY, OR CONSEQUENTIAL DAMAGES (INCLUDING, BUT NOT LIMITED TO, PROCUREMENT OF SUBSTITUTE GOODS OR SERVICES; LOSS OF USE, DATA, OR PROFITS; OR BUSINESS INTERRUPTION) HOWEVER CAUSED AND ON ANY THEORY OF



LIABILITY, WHETHER IN CONTRACT, STRICT LIABILITY, OR TORT (INCLUDING NEGLIGENCE OR OTHERWISE) ARISING IN ANY WAY OUT OF THE USE OF THIS SOFTWARE, EVEN IF ADVISED OF THE POSSIBILITY OF SUCH DAMAGE.

The licence and distribution terms for any publically available version or derivative of this code cannot be changed. i.e. this code cannot simply be copied and put under another distribution licence [including the GNU Public Licence.]

Python-2.0

PYTHON SOFTWARE FOUNDATION LICENSE VERSION 2

1. This LICENSE AGREEMENT is between the Python Software Foundation ("PSF"), and the Individual or Organization ("Licensee") accessing and otherwise using this software ("Python") in source or binary form and its associated documentation.
2. Subject to the terms and conditions of this License Agreement, PSF hereby grants Licensee a nonexclusive, royalty-free, world-wide license to reproduce, analyze, test, perform and/ or display publicly, prepare derivative works, distribute, and otherwise use Python alone or in any derivative version, provided, however, that PSF's License Agreement and PSF's notice of copyright, i.e., "Copyright (c) 2001, 2002, 2003, 2004, 2005, 2006 Python Software Foundation; All Rights Reserved" are retained in Python alone or in any derivative version prepared by Licensee.
3. In the event Licensee prepares a derivative work that is based on or incorporates Python or any part thereof, and wants to make the derivative work available to others as provided herein, then Licensee hereby agrees to include in any such work a brief summary of the changes made to Python.
4. PSF is making Python available to Licensee on an "AS IS" basis. PSF MAKES NO REPRESENTATIONS OR WARRANTIES, EXPRESS OR IMPLIED. BY WAY OF EXAMPLE, BUT NOT LIMITATION, PSF MAKES NO AND DISCLAIMS ANY REPRESENTATION OR WARRANTY OF MERCHANTABILITY OR FITNESS FOR ANY PARTICULAR PURPOSE OR THAT THE USE OF PYTHON WILL NOT INFRINGE ANY THIRD PARTY RIGHTS.
5. PSF SHALL NOT BE LIABLE TO LICENSEE OR ANY OTHER USERS OF PYTHON FOR ANY INCIDENTAL, SPECIAL, OR CONSEQUENTIAL DAMAGES OR LOSS AS A RESULT OF MODIFYING, DISTRIBUTING, OR OTHERWISE USING PYTHON, OR ANY DERIVATIVE THEREOF, EVEN IF ADVISED OF THE POSSIBILITY THEREOF.
6. This License Agreement will automatically terminate upon a material breach of its terms and conditions.

7. Nothing in this License Agreement shall be deemed to create any relationship of agency, partnership, or joint venture between PSF and Licensee. This License Agreement does not grant permission to use PSF trademarks or trade name in a trademark sense to endorse or promote products or services of Licensee, or any third party.

8. By copying, installing or otherwise using Python, Licensee agrees to be bound by the terms and conditions of this License Agreement.

BEOPEN.COM LICENSE AGREEMENT FOR PYTHON 2.0

BEOPEN PYTHON OPEN SOURCE LICENSE AGREEMENT VERSION 1

1. This LICENSE AGREEMENT is between BeOpen.com ("BeOpen"), having an office at 160 Saratoga Avenue, Santa Clara, CA 95051, and the Individual or Organization ("Licensee") accessing and otherwise using this software in source or binary form and its associated documentation ("the Software").

2. Subject to the terms and conditions of this BeOpen Python License Agreement, BeOpen hereby grants Licensee a non-exclusive, royalty-free, world-wide license to reproduce, analyze, test, perform and/or display publicly, prepare derivative works, distribute, and otherwise use the Software alone or in any derivative version, provided, however, that the BeOpen Python License is retained in the Software, alone or in any derivative version prepared by Licensee.

3. BeOpen is making the Software available to Licensee on an "AS IS" basis. BEOPEN MAKES NO REPRESENTATIONS OR WARRANTIES, EXPRESS OR IMPLIED, BY WAY OF EXAMPLE, BUT NOT LIMITATION, BEOPEN MAKES NO AND DISCLAIMS ANY REPRESENTATION OR WARRANTY OF MERCHANTABILITY OR FITNESS FOR ANY PARTICULAR PURPOSE OR THAT THE USE OF THE SOFTWARE WILL NOT INFRINGE ANY THIRD PARTY RIGHTS.

4. BEOPEN SHALL NOT BE LIABLE TO LICENSEE OR ANY OTHER USERS OF THE SOFTWARE FOR ANY INCIDENTAL, SPECIAL, OR CONSEQUENTIAL DAMAGES OR LOSS AS A RESULT OF USING, MODIFYING OR DISTRIBUTING THE SOFTWARE, OR ANY DERIVATIVE THEREOF, EVEN IF ADVISED OF THE POSSIBILITY THEREOF.

5. This License Agreement will automatically terminate upon a material breach of its terms and conditions.

6. This License Agreement shall be governed by and interpreted in all respects by the law of the State of California, excluding conflict of law provisions. Nothing in this License Agreement shall be deemed to create any relationship of agency, partnership, or joint venture between



BeOpen and Licensee. This License Agreement does not grant permission to use BeOpen trademarks or trade names in a trademark sense to endorse or promote products or services of Licensee, or any third party. As an exception, the "BeOpen Python" logos available at <http://www.pythonlabs.com/logos.html> may be used according to the permissions granted on that web page.

7. By copying, installing or otherwise using the software, Licensee agrees to be bound by the terms and conditions of this License Agreement.

CNRI OPEN SOURCE LICENSE AGREEMENT (for Python 1.6b1)

IMPORTANT: PLEASE READ THE FOLLOWING AGREEMENT CAREFULLY.

BY CLICKING ON "ACCEPT" WHERE INDICATED BELOW, OR BY COPYING, INSTALLING OR OTHERWISE USING PYTHON 1.6, beta 1 SOFTWARE, YOU ARE DEEMED TO HAVE AGREED TO THE TERMS AND CONDITIONS OF THIS LICENSE AGREEMENT.

1. This LICENSE AGREEMENT is between the Corporation for National Research Initiatives, having an office at 1895 Preston White Drive, Reston, VA 20191 ("CNRI"), and the Individual or Organization ("Licensee") accessing and otherwise using Python 1.6, beta 1 software in source or binary form and its associated documentation, as released at the www.python.org Internet site on August 4, 2000 ("Python 1.6b1").

2. Subject to the terms and conditions of this License Agreement, CNRI hereby grants Licensee a non-exclusive, royalty-free, world-wide license to reproduce, analyze, test, perform and/or display publicly, prepare derivative works, distribute, and otherwise use Python 1.6b1 alone or in any derivative version, provided, however, that CNRI's License Agreement is retained in Python 1.6b1, alone or in any derivative version prepared by Licensee.

Alternately, in lieu of CNRI's License Agreement, Licensee may substitute the following text (omitting the quotes): "Python 1.6, beta 1, is made available subject to the terms and conditions in CNRI's License Agreement. This Agreement may be located on the Internet using the following unique, persistent identifier (known as a handle): 1895.22/1011. This Agreement may also be obtained from a proxy server on the Internet using the URL:<http://hdl.handle.net/1895.22/1011>".

3. In the event Licensee prepares a derivative work that is based on or incorporates Python 1.6b1 or any part thereof, and wants to make the derivative work available to the public as provided herein, then Licensee hereby agrees to indicate in any such work the nature of the modifications made to Python 1.6b1.



4. CNRI is making Python 1.6b1 available to Licensee on an "AS IS" basis. CNRI MAKES NO REPRESENTATIONS OR WARRANTIES, EXPRESS OR IMPLIED. BY WAY OF EXAMPLE, BUT NOT LIMITATION, CNRI MAKES NO AND DISCLAIMS ANY REPRESENTATION OR WARRANTY OF MERCHANTABILITY OR FITNESS FOR ANY PARTICULAR PURPOSE OR THAT THE USE OF PYTHON 1.6b1 WILL NOT INFRINGE ANY THIRD PARTY RIGHTS.

5. CNRI SHALL NOT BE LIABLE TO LICENSEE OR ANY OTHER USERS OF THE SOFTWARE FOR ANY INCIDENTAL, SPECIAL, OR CONSEQUENTIAL DAMAGES OR LOSS AS A RESULT OF USING, MODIFYING OR DISTRIBUTING PYTHON 1.6b1, OR ANY DERIVATIVE THEREOF, EVEN IF ADVISED OF THE POSSIBILITY THEREOF.

6. This License Agreement will automatically terminate upon a material breach of its terms and conditions.

7. This License Agreement shall be governed by and interpreted in all respects by the law of the State of Virginia, excluding conflict of law provisions. Nothing in this License Agreement shall be deemed to create any relationship of agency, partnership, or joint venture between CNRI and Licensee. This License Agreement does not grant permission to use CNRI trademarks or trade name in a trademark sense to endorse or promote products or services of Licensee, or any third party.

8. By clicking on the "ACCEPT" button where indicated, or by copying, installing or otherwise using Python 1.6b1, Licensee agrees to be bound by the terms and conditions of this License Agreement.

ACCEPT

CWI LICENSE AGREEMENT FOR PYTHON 0.9.0 THROUGH 1.2

Copyright (c) 1991 - 1995, Stichting Mathematisch Centrum Amsterdam, The Netherlands. All rights reserved.

Permission to use, copy, modify, and distribute this software and its documentation for any purpose and without fee is hereby granted, provided that the above copyright notice appear in all copies and that both that copyright notice and this permission notice appear in supporting documentation, and that the name of Stichting Mathematisch Centrum or CWI not be used in advertising or publicity pertaining to distribution of the software without specific, written prior permission.

STICHTING MATHEMATISCH CENTRUM DISCLAIMS ALL WARRANTIES WITH REGARD TO THIS SOFTWARE, INCLUDING ALL IMPLIED WARRANTIES OF MERCHANTABILITY AND FITNESS, IN NO EVENT SHALL STICHTING MATHEMATISCH CENTRUM BE LIABLE FOR ANY



SPECIAL, INDIRECT OR CONSEQUENTIAL DAMAGES OR ANY DAMAGES WHATSOEVER RESULTING FROM LOSS OF USE, DATA OR PROFITS, WHETHER IN AN ACTION OF CONTRACT, NEGLIGENCE OR OTHER TORTIOUS ACTION, ARISING OUT OF OR IN CONNECTION WITH THE USE OR PERFORMANCE OF THIS SOFTWARE.

SGI-B-2.0

SGI FREE SOFTWARE LICENSE B

(Version 2.0, Sept. 18, 2008)

Copyright (C) [dates of first publication] Silicon Graphics, Inc. All Rights Reserved.

Permission is hereby granted, free of charge, to any person obtaining a copy of this software and associated documentation files (the "Software"), to deal in the Software without restriction, including without limitation the rights to use, copy, modify, merge, publish, distribute, sublicense, and/or sell copies of the Software, and to permit persons to whom the Software is furnished to do so, subject to the following conditions:

The above copyright notice including the dates of first publication and either this permission notice or a reference to <http://oss.sgi.com/projects/FreeB/> shall be included in all copies or substantial portions of the Software.

THE SOFTWARE IS PROVIDED "AS IS", WITHOUT WARRANTY OF ANY KIND, EXPRESS OR IMPLIED, INCLUDING BUT NOT LIMITED TO THE WARRANTIES OF MERCHANTABILITY, FITNESS FOR A PARTICULAR PURPOSE AND NONINFRINGEMENT. IN NO EVENT SHALL SILICON GRAPHICS, INC. BE LIABLE FOR ANY CLAIM, DAMAGES OR OTHER LIABILITY, WHETHER IN AN ACTION OF CONTRACT, TORT OR OTHERWISE, ARISING FROM, OUT OF OR IN CONNECTION WITH THE SOFTWARE OR THE USE OR OTHER DEALINGS IN THE SOFTWARE.

Except as contained in this notice, the name of Silicon Graphics, Inc. shall not be used in advertising or otherwise to promote the sale, use or other dealings in this Software without prior written authorization from Silicon Graphics, Inc.

STLport License

Boris Fomitchev grants Licensee a non-exclusive, non-transferable, royalty-free license to use STLport and its documentation without fee.

By downloading, using, or copying STLport or any portion thereof, Licensee agrees to abide by the intellectual property laws and all other applicable laws of the United States of America,

and to all of the terms and conditions of this Agreement.

Licensee shall maintain the following copyright and permission notices on STLport sources and its documentation unchanged :

Copyright 1999,2000 Boris Fomitchev

This material is provided "as is", with absolutely no warranty expressed or implied. Any use is at your own risk.

Permission to use or copy this software for any purpose is hereby granted without fee, provided the above notices are retained on all copies. Permission to modify the code and to distribute modified code is granted, provided the above notices are retained, and a notice that the code was modified is included with the above copyright notice.

The Licensee may distribute binaries compiled with STLport (whether original or modified) without any royalties or restrictions.

The Licensee may distribute original or modified STLport sources, provided that:

The conditions indicated in the above permission notice are met;

The following copyright notices are retained when present, and conditions provided in accompanying permission notices are met:

Copyright 1994 Hewlett-Packard Company

Copyright 1996,97 Silicon Graphics Computer Systems, Inc.

Copyright 1997 Moscow Center for SPARC Technology.

Permission to use, copy, modify, distribute and sell this software and its documentation for any purpose is hereby granted without fee, provided that the above copyright notice appear in all copies and that both that copyright notice and this permission notice appear in supporting documentation. Hewlett-Packard Company makes no representations about the suitability of this software for any purpose. It is provided "as is" without express or implied warranty.

Permission to use, copy, modify, distribute and sell this software and its documentation for any purpose is hereby granted without fee, provided that the above copyright notice appear in all copies and that both that copyright notice and this permission notice appear in supporting documentation. Silicon Graphics makes no representations about the suitability of this software for any purpose. It is provided "as is" without express or implied warranty.

Permission to use, copy, modify, distribute and sell this software and its documentation for any purpose is hereby granted without fee, provided that the above copyright notice appear in

all copies and that both that copyright notice and this permission notice appear in supporting documentation. Moscow Center for SPARC Technology makes no representations about the suitability of this software for any purpose. It is provided "as is" without express or implied warranty.

Software License for The Fraunhofer FDK AAC Codec Library for Android

1. INTRODUCTION

The Fraunhofer FDK AAC Codec Library for Android ("FDK AAC Codec") is software that implements the MPEG Advanced Audio Coding ("AAC") encoding and decoding scheme for digital audio. This FDK AAC Codec software is intended to be used on a wide variety of Android devices.

AAC's HE-AAC and HE-AAC v2 versions are regarded as today's most efficient general perceptual audio codecs. AAC-ELD is considered the best-performing full-bandwidth communications codec by independent studies and is widely deployed. AAC has been standardized by ISO and IEC as part of the MPEG specifications.

Patent licenses for necessary patent claims for the FDK AAC Codec (including those of Fraunhofer) may be obtained through Via Licensing (www.vialicensing.com) or through the respective patent owners individually for the purpose of encoding or decoding bit streams in products that are compliant with the ISO/IEC MPEG audio standards. Please note that most manufacturers of Android devices already license these patent claims through Via Licensing or directly from the patent owners, and therefore FDK AAC Codec software may already be covered under those patent licenses when it is used for those licensed purposes only.

Commercially-licensed AAC software libraries, including floating-point versions with enhanced sound quality, are also available from Fraunhofer. Users are encouraged to check the Fraunhofer website for additional applications information and documentation.

2. COPYRIGHT LICENSE

Redistribution and use in source and binary forms, with or without modification, are permitted without payment of copyright license fees provided that you satisfy the following conditions:

You must retain the complete text of this software license in redistributions of the FDK AAC Codec or your modifications thereto in source code form.

You must retain the complete text of this software license in the documentation and/or other materials provided with redistributions of the FDK AAC Codec or your modifications thereto in binary form. You must make available free of charge copies of the complete source code of the FDK AAC Codec and your modifications thereto to recipients of copies in binary form.

The name of Fraunhofer may not be used to endorse or promote products derived from this library without prior written permission.

You may not charge copyright license fees for anyone to use, copy or distribute the FDK AAC Codec software or your modifications thereto.

Your modified versions of the FDK AAC Codec must carry prominent notices stating that you changed the software and the date of any change. For modified versions of the FDK AAC Codec, the term "Fraunhofer FDK AAC Codec Library for Android" must be replaced by the term "Third-Party Modified Version of the Fraunhofer FDK AAC Codec Library for Android."

3. NO PATENT LICENSE

NO EXPRESS OR IMPLIED LICENSES TO ANY PATENT CLAIMS, including without limitation the patents of Fraunhofer, ARE GRANTED BY THIS SOFTWARE LICENSE. Fraunhofer provides no warranty of patent non-infringement with respect to this software.

You may use this FDK AAC Codec software or modifications thereto only for purposes that are authorized by appropriate patent licenses.

4. DISCLAIMER

This FDK AAC Codec software is provided by Fraunhofer on behalf of the copyright holders and contributors "AS IS" and WITHOUT ANY EXPRESS OR IMPLIED WARRANTIES, including but not limited to the implied warranties of merchantability and fitness for a particular purpose. IN NO EVENT SHALL THE COPYRIGHT HOLDER OR CONTRIBUTORS BE LIABLE for any direct, indirect, incidental, special, exemplary, or consequential damages, including but not limited to procurement of substitute goods or services; loss of use, data, or profits, or business interruption, however caused and on any theory of liability, whether in contract, strict liability, or tort (including negligence), arising in any way out of the use of this software, even if advised of the possibility of such damage.

5. CONTACT INFORMATION

Fraunhofer Institute for Integrated Circuits IIS
Attention: Audio and Multimedia Departments - FDK AAC LL
Am Wolfsmantel 33
91058 Erlangen, Germany

www.iis.fraunhofer.de/amm
amm-info@iis.fraunhofer.de

Permission is hereby granted, free of charge, to any person obtaining a copy of this software and associated documentation files (the "Software"), to deal in the Software without restriction, including without limitation the rights to use, copy, modify, merge, publish, distribute, sublicense, and/or sell copies of the Software, and to permit persons to whom the Software is furnished to do so, subject to the following conditions:

The above copyright notice and this permission notice shall be included in all copies or substantial portions of the Software.

THE SOFTWARE IS PROVIDED "AS IS", WITHOUT WARRANTY OF ANY KIND, EXPRESS OR IMPLIED, INCLUDING BUT NOT LIMITED TO THE WARRANTIES OF MERCHANTABILITY, FITNESS FOR A PARTICULAR PURPOSE AND NONINFRINGEMENT. IN NO EVENT SHALL THE AUTHORS OR COPYRIGHT HOLDERS BE LIABLE FOR ANY CLAIM, DAMAGES OR OTHER LIABILITY, WHETHER IN AN ACTION OF CONTRACT, TORT OR OTHERWISE, ARISING FROM, OUT OF OR IN CONNECTION WITH THE SOFTWARE OR THE USE OR OTHER DEALINGS IN THE SOFTWARE.

Except as contained in this notice, the name of the authors or copyright holders shall not be used in advertising or otherwise to promote the sale, use or other dealings in this Software without prior written authorization from the authors or copyright holders.

Zlib

zlib License

This software is provided 'as-is', without any express or implied warranty. In no event will the authors be held liable for any damages arising from the use of this software.

Permission is granted to anyone to use this software for any purpose, including commercial applications, and to alter it and redistribute it freely, subject to the following restrictions:

1. The origin of this software must not be misrepresented; you must not claim that you wrote the original software. If you use this software in a product, an acknowledgment in the product documentation would be appreciated but is not required.
2. Altered source versions must be plainly marked as such, and must not be misrepresented as being the original software.
3. This notice may not be removed or altered from any source distribution.



bzip2-1.0.6

This program, "bzip2", the associated library "libbzip2", and all documentation, are copyright (C) 1996-2010 Julian R Seward. All rights reserved.

Redistribution and use in source and binary forms, with or without modification, are permitted provided that the following conditions are met:

1. Redistributions of source code must retain the above copyright notice, this list of conditions and the following disclaimer.
2. The origin of this software must not be misrepresented; you must not claim that you wrote the original software. If you use this software in a product, an acknowledgment in the product documentation would be appreciated but is not required.
3. Altered source versions must be plainly marked as such, and must not be misrepresented as being the original software.
4. The name of the author may not be used to endorse or promote products derived from this software without specific prior written permission.

THIS SOFTWARE IS PROVIDED BY THE AUTHOR ``AS IS" AND ANY EXPRESS OR IMPLIED WARRANTIES, INCLUDING, BUT NOT LIMITED TO, THE IMPLIED WARRANTIES OF MERCHANTABILITY AND FITNESS FOR A PARTICULAR PURPOSE ARE DISCLAIMED. IN NO EVENT SHALL THE AUTHOR BE LIABLE FOR ANY DIRECT, INDIRECT, INCIDENTAL, SPECIAL, EXEMPLARY, OR CONSEQUENTIAL DAMAGES (INCLUDING, BUT NOT LIMITED TO, PROCUREMENT OF SUBSTITUTE GOODS OR SERVICES; LOSS OF USE, DATA, OR PROFITS; OR BUSINESS INTERRUPTION) HOWEVER CAUSED AND ON ANY THEORY OF LIABILITY, WHETHER IN CONTRACT, STRICT LIABILITY, OR TORT (INCLUDING NEGLIGENCE OR OTHERWISE) ARISING IN ANY WAY OUT OF THE USE OF THIS SOFTWARE, EVEN IF ADVISED OF THE POSSIBILITY OF SUCH DAMAGE.

Julian Seward, jseward@bzip.org bzip2/libbzip2 version 1.0.6 of 6 September 2010

curl

Copyright (c) 1996 - 2015, Daniel Stenberg, <daniel@haxx.se>.

All rights reserved.

Permission to use, copy, modify, and distribute this software for any purpose with or without fee is hereby granted, provided that the above copyright notice and this permission notice

appear in all copies.

THE SOFTWARE IS PROVIDED "AS IS", WITHOUT WARRANTY OF ANY KIND, EXPRESS OR IMPLIED, INCLUDING BUT NOT LIMITED TO THE WARRANTIES OF MERCHANTABILITY, FITNESS FOR A PARTICULAR PURPOSE AND NONINFRINGEMENT OF THIRD PARTY RIGHTS. IN NO EVENT SHALL THE AUTHORS OR COPYRIGHT HOLDERS BE LIABLE FOR ANY CLAIM, DAMAGES OR OTHER LIABILITY, WHETHER IN AN ACTION OF CONTRACT, TORT OR OTHERWISE, ARISING FROM, OUT OF OR IN CONNECTION WITH THE SOFTWARE OR THE USE OR OTHER DEALINGS IN THE SOFTWARE.

Except as contained in this notice, the name of a copyright holder shall not be used in advertising or otherwise to promote the sale, use or other dealings in this Software without prior written authorization of the copyright holder.

libpng-2.0

PNG Reference Library License version 2

- * Copyright (c) 1995-2018 The PNG Reference Library Authors.
- * Copyright (c) 2018 Cosmin Truta.
- * Copyright (c) 2000-2002, 2004, 2006-2018 Glenn Randers-Pehrson.
- * Copyright (c) 1996-1997 Andreas Dilger.
- * Copyright (c) 1995-1996 Guy Eric Schalnat, Group 42, Inc.

The software is supplied "as is", without warranty of any kind, express or implied, including, without limitation, the warranties of merchantability, fitness for a particular purpose, title, and non-infringement. In no even shall the Copyright owners, or anyone distributing the software, be liable for any damages or other liability, whether in contract, tort or otherwise, arising from, out of, or in connection with the software, or the use or other dealings in the software, even if advised of the possibility of such damage.

Permission is hereby granted to use, copy, modify, and distribute this software, or portions hereof, for any purpose, without fee, subject to the following restrictions:

1. The origin of this software must not be misrepresented; you must not claim that you wrote the original software. If you use this software in a product, an acknowledgment in the product documentation would be appreciated, but is not required.
2. Altered source versions must be plainly marked as such, and must not be misrepresented as being the original software.
3. This Copyright notice may not be removed or altered from any source or altered source distribution.