



GENESIS G90

Thank you for purchasing this Gen5 Premium Class Navigation.

This user's manual explains how to use the Gen5 Premium Class Navigation.

Before using the product, read the contents of this user's manual carefully and use this product safely.

- The screens shown in this manual may differ with the actual screens of the product.
- The design and specification of this product may change without prior notification for product improvement.
- When transferring the vehicle to another individual, include this user's manual so that the next driver can continue its use.

here

Maps for Life

All Map Database cannot be copied without permission.

Important Notice:

This is protected by U.S. copyright laws. All rights not expressly granted are reserved.

You may not otherwise reproduce, modify, and distribute the content without Hyundai MnSoft, Inc's prior written consent.



TABLE OF CONTENTS

TABLE OF CONTENTS	3	HOME SCREEN	30
		BASIC OPERATION OF HOME SCREEN	30
		CUSTOMIZING HOME SCREEN	32
START		FAVORITES	33
NAME OF EACH COMPONENT		ADDING YOUR FAVORITE MENU ITEMS TO [FAVORITES] MENU	33
13		REARRANGING YOUR FAVORITE MENU	35
HEAD UNIT	13	DELETING YOUR FAVORITE MENU	36
DISC DECK	15		
CCP (CENTRAL CONTROLLER PANEL)	16	NAVIGATION	
RRC (REAR REMOTE CONTROL) - OPTION A	17	GETTING STARTED WITH NAVIGATION	38
RRC (REAR REMOTE CONTROL) - OPTION B	19	GENERAL INFORMATION OF NAVIGATION USE	38
STEERING WHEEL REMOTE CONTROL	21	NAVIGATION USE RESTRICTIONS	38
		WHAT IS GNSS?	39
BASIC OPERATION	23	ABOUT SATELLITE SIGNALS	39
SYSTEM ON/OFF	23	ACQUIRING SATELLITE SIGNALS	39
STARTING THE SYSTEM FOR THE FIRST TIME	23	MAP SCREEN	40
TURNING THE SYSTEM OFF	23	OPERATING NAVIGATION	43
AV ON/OFF OR VOLUME ADJUSTMENT	24	ZOOM IN / ZOOM OUT	43
AV OFF	24	MAP SCALE	44
AV ON	24	MAKING A CALL TO POI	45
ADJUSTING THE VOLUME	24	GUIDANCE TO PREVIOUS DESTINATIONS 46	
RESETTING THE SYSTEM	24	SCROLLING MAP	47
USING THE CONTROLLER	25	NAVIGATION MENU	48
USING THE TOUCH SCREEN	26	SEARCHING FOR POI	49
GENERAL OPERATION OF THE MENU IN AVAILABLE MODE	27	POI SEARCH	49
SPLIT SCREEN	27		
SOUND SETTINGS	28		
DISPLAY SETTINGS	28		
SWITCHING TO SIMPLE VIEW OR NORMAL VIEW	29		



DISPLAYING/HIDING POI ICONS ON THE MAP SCREEN	51
EDITING POI CATEGORY	52
ADDING THE POSITION TO ADDRESS BOOK	53
TRAFFIC INFORMATION LIST	54
NAVIGATION VOLUME	55
NAVIGATION SETTINGS	55
SEARCHING FOR DESTINATION OF NAVIGATION	56
SEARCH	56
PREVIOUS DESTINATIONS	58
ADDRESS BOOK	59
ADDING TO A LOCATION TO THE [MY PLACES] MENU	60
EDITING ADDRESS BOOK	61
DELETING ADDRESS BOOK	61
MY DATA	62
POI CATEGORIES	63
EMERGENCY	64
HOME / WORK / FAVORITES	65
REGISTERING HOME, WORK OR FAVORITE PLACE	65
FINDING YOUR HOME, WORK OR FAVORITE PLACE	65
USING THE ROUTE MENU	66
CANCEL ROUTE	66
ROUTE OPTIONS	66
EDIT ROUTE	67
ADDING WAYPOINTS	67
REORDERING ROUTE	68
DELETING ROUTE	68
ROUTE OVERVIEW	69
ROUTE INFO. / AVOID	70

GENESIS CONNECTED

SERVICES

GENESIS CONNECTED SERVICES 72

BEFORE USING CONNECTED SERVICES	72
WHAT IS CONNECTED SERVICES?	72
WHAT IS TELEMATICS?	72
ABOUT TRANSMISSION AND RECEPTION OF RADIO WAVES	72
GETTING STARTED WITH CONNECTED SERVICES	73
INTERIOR LIGHT BUTTON	74
CONNECTING WITH THE CONNECTED CENTER	74
VOICE LOCAL SEARCH	75
WHAT IS VOICE LOCAL SEARCH?	75
STARTING VOICE LOCAL SEARCH	75
SEND TO CAR	76
VIEW SEND TO CAR	76
DELETING SEND TO CAR	77
VEHICLE DIAGNOSTICS	78
CONNECTED SETTINGS	79
SERVICE ACTIVATION	79
MODEM INFORMATION	80
CONNECTED SERVICES FEATURES	81
SAFETY	81
AUTOMATIC COLLISION NOTIFICATION AND ASSISTANCE	81
SOS EMERGENCY ASSISTANCE	81
CAR CARE	82
MONTHLY VEHICLE HEALTH REPORT	82
AUTOMATIC DIAGNOSTICS TROUBLE CODE NOTIFICATION	82
MAINTENANCE ALERT	82
REMOTE SERVICE	83
REMOTE DOOR LOCK/UNLOCK	83
REMOTE HORN/LIGHTS	83
REMOTE START WITH CLIMATE CONTROL	83



CAR FINDER	83
VEHICLE SAFEGUARD	84
STOLEN VEHICLE RECOVERY	84
VEHICLE SLOWDOWN	84
VEHICLE IMMOBILIZATION	84
PANIC NOTIFICATION	84
ALARM NOTIFICATION	84
VALET ALERT	85
GEO FENCE ALERT	85
SPEED ALERT	85
CURFEW ALERT	85

DRIVER ASSISTANCE

DRIVER ASSISTANCE	87
SCC REACTION	87
DRIVING ASSIST	87
WARNING TIMING	88
WARNING VOLUME	88
HAPTIC WARNING	88
DRIVER ATTENTION WARNING	88
FORWARD SAFETY	88
LANE SAFETY	88
BLIND-SPOT SAFETY	89
PARKING SAFETY	89

DATA SERVICES

ABOUT HD DATA SERVICES	91
ACCESSING HD DATA SERVICES	91
TRAFFIC	92
WEATHER	93
DOPPLER RADAR	94
FUEL PRICES	95
FINDING GAS STATION	95

SEARCHING FOR GAS STATION	96
FAVORITES	97
ADDING TO FAVORITES	97
DELETING FAVORITES	98

MEDIA

PLAYING AUDIO CD/MP3 CD 100

PAUSE	100
SKIP	101
SEARCH	101
SEEK	101
LIST	102
SHUFFLE	102
REPEAT	103
SONG INFORMATION	103

PLAYING DVD 104

PAUSE	104
SKIP	104
SEARCH	105
SEEK	105
SWITCHING TO MENU SCREEN OR FULL SCREEN	105
TITLE MENU/DISC MENU	106
SUBTITLE LANGUAGE	107
VOICE LANGUAGE	107
ANGLE	108
DVD SETTINGS	109
DVD LANGUAGE CODE	110

PLAYING USB 113

PLAYING USB MUSIC	113
PAUSE	113
SKIP	113



SEARCH.....	114	SKIP.....	129
SEEK.....	114	SHUFFLE.....	129
LIST.....	114	REPEAT.....	129
SHUFFLE.....	115	SONG INFORMATION.....	130
REPEAT.....	115	CONNECTION SETTINGS.....	130
SONG INFORMATION.....	116		
HIDE CURRENT FILE.....	116		
SONGS OF THIS ARTIST.....	117		
SONGS OF THIS ALBUM.....	117		
PLAYING USB VIDEO.....	118		
PAUSE.....	118		
SKIP.....	118		
SEARCH.....	119		
SEEK.....	119		
SWITCHING TO MENU SCREEN OR FULL SCREEN.....	119		
LIST.....	119		
REPEAT.....	120		
FILE INFORMATION.....	121		
SUBTITLE SETTINGS.....	122		
VOICE SETTINGS.....	122		
PLAYING IPOD®.....	123		
PAUSE.....	123		
SKIP.....	123		
SEARCH.....	124		
SEEK.....	124		
LIST.....	124		
SEARCHING THE LIST.....	124		
REORDERING CATEGORIES.....	125		
SHUFFLE.....	125		
REPEAT.....	126		
SONG INFORMATION.....	127		
PLAYING BLUETOOTH® AUDIO 128			
BEFORE PLAYING THE BLUETOOTH® AUDIO.....	128		
STARTING THE BLUETOOTH® AUDIO.....	128		
PAUSE.....	128		
		RADIO	
		LISTENING TO FM/AM RADIO 132	
		AUTO TUNING.....	132
		MANUAL TUNING.....	132
		PRESET TUNING.....	132
		SAVING FM/AM AS PRESETS.....	133
		DELETING FM/AM PRESETS.....	134
		SCANNING FM/AM BROADCAST STATION.....	134
		STATION LIST.....	135
		REORDERING FM/AM PRESET.....	135
		RADIO TEXT ON/OFF.....	136
		LISTENING TO HD RADIO™ 137	
		HD RADIO™ SCREEN.....	137
		HD RADIO™ ON/OFF.....	138
		LISTENING TO SIRIUSXM™ RADIO 139	
		SIRIUSXM™ SCREEN.....	139
		SELECTING SIRIUSXM™ BROADCAST CHANNEL.....	141
		SELECTING A CHANNEL THROUGH MANUAL SEARCH.....	141
		SELECTING WITH CHANNEL UP/DOWN 141	
		SELECTING A CHANNEL THROUGH PRESET.....	141
		SELECTING CHANNEL THROUGH	



CHANNEL/CATEGORY LIST	141
SCANNING SIRIUSXM™ BROADCAST CHANNEL	142
ENTER CHANNEL	143
SAVING SIRIUSXM™ PRESET	143
PROGRAM GUIDE	144
ADDING TO FAVORITES	145
REORDERING SIRIUSXM™ PRESET	146
GAME ZONE	147
SETTING TEAM	147
VIEWING ACTIVE ALERT	148
ALERT ON/OFF	149
FAVORITES	150
VIEWING ACTIVE ALERT	150
DELETING THE SONG OR ARTIST SAVED IN [FAVORITES] MENU	151
FAVORITES ALERT ON/OFF	152
FEATURED FAVORITES	153
SUBSCRIPTION STATUS	153

PHONE

BLUETOOTH	155
BLUETOOTH® WIRELESS TECHNOLOGY	155
WHAT IS BLUETOOTH WIRELESS TECHNOLOGY?	155
PRECAUTIONS FOR SAFE DRIVING	155
CAUTIONS UPON CONNECTING BLUETOOTH PHONE	156
PAIRING AND CONNECTING THE UNIT AND A BLUETOOTH PHONE	157
WHEN NO PHONES HAVE BEEN PAIRED	157
WHEN A PHONE IS ALREADY PAIRED	161
DISCONNECTING THE CONNECTED PHONE	165
DELETING BLUETOOTH DEVICES	166
BLUETOOTH SETTINGS	167

MAKING A CALL	168
MAKING A CALL BY ENTERING PHONE NUMBER	168
MAKING A CALL BY VOICE RECOGNITION	169
MAKING A CALL BY REDIALING	169
MAKING A CALL WITH SPEED DIAL NUMBERS	169
ANSWERING/REJECTING A CALL	170
RESPONDING WITH MESSAGES	170
SWITCHING CALL TO THE MOBILE PHONE	171
ENDING A CALL	171
USING THE MENU DURING A PHONE CALL	172
CALL HISTORY	173
MAKING A CALL FROM CALL HISTORY	173
DOWNLOADING CALL HISTORY	174
CONTACTS	175
MAKING A CALL FROM CONTACTS	175
DOWNLOADING MOBILE PHONE CONTACTS	176
SEARCHING FOR CONTACTS	177
FAVORITE CONTACTS	178
CALLING FAVORITES	178
ADDING AS A FAVORITE	179
EDITING FAVORITES	180
DELETING FAVORITES	181
DIAL SCREEN	182
MESSAGES	184
CHECKING NEW MESSAGES	184



CHECKING NEW MESSAGE CONTENTS	185	RESET	194
SYSTEM		NAVIGATION	195
VEHICLE	187	DISPLAY	195
HEAD-UP DISPLAY	187	GUIDANCE	196
ENABLE HEAD-UP DISPLAY	187	TRAFFIC	197
DISPLAY CONTROL	187	RESET	198
CONTENT SELECTION	187	BLUETOOTH	199
SPEEDOMETER	187	BLUETOOTH CONNECTIONS	199
DRIVE MODE	188	PREDEFINED MESSAGES	200
CUSTOM	188	BLUETOOTH VOICE PROMPTS	202
SPORT MODE ACTIVE SOUND DESIGN	188	AUDIO SYSTEM INFO	203
DRIVE MODE CHANGE ALERT	189	VEHICLE NAME	203
LATERAL SEAT SUPPORT ENHANCEMENT	189	PASSKEY	204
ECO COASTING	189	PRIVACY MODE	204
LIGHTS	190	RESET	205
AMBIENT LIGHT	190	CONNECTED SETTINGS	206
ONE TOUCH TURN SIGNAL	190	ACTIVATE CONNECTED SERVICES	206
HEADLIGHT DELAY	190	MODEM INFORMATION	207
DOOR/TRUNK	191	PHONE PROJECTION	208
AUTO LOCK	191	ADVANCED	209
AUTO UNLOCK	191	CUSTOM BUTTON	209
2 PRESS UNLOCK	191	HOME SCREEN LAYOUT	210
POWER TRUNK OPENING HEIGHT	191	MEDIA CHANGE NOTICES	211
SMART TRUNK	191	MODE BUTTON (STEERING WHEEL)	211
CLUSTER	192	HOME BUTTON (ROTARY CONTROLLER)	212
SERVICE INTERVAL	192	DATE/TIME	213
ENERGY CONSUMPTION RESET	192	GPS TIME	213
CONTENT SELECTION	192	TIME SETTINGS	214
WELCOME SOUND	192	DAYLIGHT SAVING TIME	214
CONVENIENCE	193	TIME ZONE	215
SEAT POSITION CHANGE ALERT	193		
SMART POSTURE CARE	193		
HEATED/VENTILATED FEATURES	193		
SEAT/STEERING WHEEL	194		
WELCOME MIRROR/LIGHT	194		
WIRELESS CHARGING SYSTEM	194		



TIME FORMAT	215	VOICE RECOGNITION	234
RESET ANALOG CLOCK	216		
GENERAL	217	SYSTEM INFORMATION CHECK AND UPDATE GUIDE	235
REAR DISPLAY ON/OFF (OPTION) . . .	217	SOFTWARE INFORMATION	235
LOCK REAR CONTROLS	217	UPDATE	236
LANGUAGE	218	STORAGE	236
KEYBOARD	219	WEB MANUAL	237
RETURN TO MAP: SET TIME	219	RESET	237
UNIT	220		
SCREEN SAVER	220	OTHERS	
SOUND	221	<hr/>	
BEEP	221	ABOUT PHONE PROJECTION	
POSITION	221	239	
EQUALIZER	222	WHAT IS ANDROID AUTO/APPLE CARPLAY?	239
PRIORITY	223	USING ANDROID AUTO OR APPLE CARPLAY	241
VOLUME (SYSTEM)	223	VOICE MEMO	242
VOLUME (PHONE PROJECTION)	224	MAKING A VOICE MEMO	242
NAVIGATION VOLUME	225	START	242
SPEED DEPENDENT VOL.	225	PAUSE	242
LIVE DYNAMIC (OPTION)	226	STOP	242
QUANTUM LOGIC SURROUND (OPTION) 226		PLAYING A VOICE MEMO	243
CLARI-FI (OPTION)	227	PAUSE	243
VIP SOUND (OPTION)	227	SKIP	243
RESET	228	SEARCH	243
DISPLAY	229	SAVING THE VOICE MEMO TO USB DEVICE	244
DISPLAY OFF	229	STORAGE INFORMATION	244
ILLUMINATION	230	DELETING VOICE MEMO	245
MODE	231	VOICE RECOGNITION SYSTEM	246
ADJUST VIDEO	232	WHAT IS VOICE RECOGNITION?	246
VIDEO DISPLAY RATIO	233		
RESET	233		



VOICE RECOGNITION FEATURES BY LANGUAGE	246	MONITOR) - OPTION	269
OPERATING VOICE COMMAND	246	ABOUT SVM (SURROUND VIEW MONITOR)	269
CONDITION FOR VOICE COMMAND SYSTEM	246	OPERATING FRONT SVM	269
STARTING VOICE RECOGNITION	247	OPERATING REAR SVM	271
SKIPPING PROMPT MESSAGES	247	SVM SETTING	272
RE-STARTING VOICE RECOGNITION	247	WARNING DISPLAY	273
ENDING VOICE RECOGNITION	247	DRIVER'S DOOR OPEN INDICATOR	273
ADJUSTING VOICE RECOGNITION VOLUME	247	FRONT PASSENGER'S DOOR OPEN INDICATOR	273
BASIC OPERATION FOR VOICE COMMAND (SETTING FM)	248	TRUNK OPEN INDICATOR	273
VOICE RECOGNITION QUICK START (MANUAL CONTROL)	248	SIDE MIRROR FOLDING INDICATOR	273
ABOUT VOICE COMMAND "HELP"	249	DRIVING INFO	274
VOICE COMMAND LIST	250	CHECKING DRIVING INFO	274
PHONE COMMANDS	250	CLIMATE	275
RADIO COMMANDS	252	CLIMATE MODE	275
NAVIGATION COMMANDS	253	REAR CLIMATE CONTROLS	277
OTHER COMMANDS (COMMANDS USED IN LIST / HELP/ ETC.)	255	CLIMATE MENU	278
LIST OF NEAREST LOCATIONS	256	REFERENCE	
SIRI®	266	PRECAUTIONS FOR SAFETY	280
ABOUT SIRI®	266	NOTATIONS USED WITHIN THIS USER'S MANUAL	280
WHAT IS SIRI®?	266	FCC NOTICE (FOR USA)	284
USING SIRI®	266	FCC RF RADIATION EXPOSURE STATEMENT	285
STARTING SIRI®	266	INDUSTRY CANADA STATEMENT	285
RE-STARTING SIRI®	267	IC RADIATION EXPOSURE STATEMENT (FOR CANADA)	285
ENDING SIRI®	267	GENERAL INFORMATION	286
ADJUSTING SIRI® VOLUME	267	INFORMATION ON DISC	286
USING REAR CAMERA - OPTION 268		CAUTIONS TO USE DISC	286
ABOUT REAR CAMERA	268	PLAYABLE DISCS	287
TURNING ON THE REAR CAMERA	268		
BACKING UP & USING CAMERA	268		
SVM (SURROUND VIEW			



ON COPYRIGHT	287	CONNECTED SERVICES TERMINAL PRODUCT SPECIFICATION	308
DVD REGIONAL CODES	287		
CAUTIONS FOR THE USE OF USB . . .	288	OPEN SOURCE SOFTWARE NOTICE	309
PLAYABLE FILE STANDARD	289		
PLAYABLE AUDIO FILE SPECIFICATIONS (USB)	289		
PLAYABLE AUDIO FILE SPECIFICATIONS (DISC)	289		
DIVX FILE STANDARD	289		
THE INFORMATION ABOUT IPOD . . .	290		
PRECAUTIONS FOR THE USE OF IPOD . .	290		
IPOD LISTS THAT RECEIVE SUPPORT	290		
BEFORE THINKING THE PRODUCT HAS MALFUNCTIONED	291		
BEFORE YOU THINK THE PRODUCT IS DEFECTIVE	293		
TROUBLESHOOTING	295		
TRADEMARKS AND LICENSES 298			
IPOD®	298		
SIRIUSXM™	298		
DTS®	298		
BLUETOOTH® WIRELESS TECHNOLOGY .	298		
HD RADIO™ TECHNOLOGY	298		
NAVIGATION	299		
END USER LICENSE AGREEMENT . .	299		
TERMS AND CONDITIONS	299		
COPYRIGHT FOR BRAND ICON . .	305		
COPYRIGHT FOR JUNCTION VIEW	305		
ABOUT MAP UPDATES	305		
SPECIFICATION	306		
AV/NAVIGATION PRODUCT SPECIFICATION	306		

START





NAME OF EACH COMPONENT

HEAD UNIT

The image of this product may be different from the actual product.

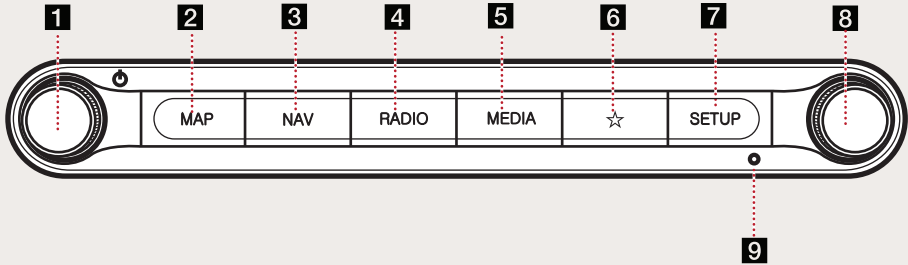

1 Power (⏻) button

- Power on: Press this button in power OFF status.
- Power off: Press and hold this button in power ON status.
- Press this button to turn AV on or off in power ON status.

Volume control knob

Turn left/right to control volume.

2 MAP button

- Press to display the map screen of the current location.
- Press to repeat the voice guidance when a destination is set.

3 NAV button

Press to display the [Navigation Menu] screen.

4 RADIO button

Selects the FM/AM/SiriusXM band. Each time the button is pressed, the mode is changed in order to FM > AM > SiriusXM > FM. Press to display the [Radio] screen.

5 MEDIA button

Press this button to move to the media playing screen. Press this button again to display the [Media] menu screen.

6 ☆ (Custom button)

Press to move to the [Custom button] menu. After setting a desired function, press to use the desired function. After setting it, press and hold to move to the [Custom button] menu.

7 SETUP button

Press to move to the [Settings] menu.



8 TUNE/FILE knob

- FM/AM: Turn to change the frequency.
- SiriusXM mode: Turn to change the channel.
- Media mode (except for Bluetooth): Turn to search for the desired file.

9 RESET hole

Press to reset the unit.



DISC DECK

Disc deck is an option for the customers who selected the option.

The image of this product may be different from the actual product.

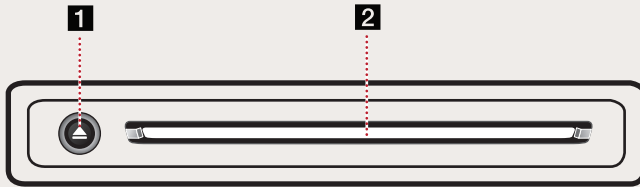

1  button

Press to eject disc.

2 Disc slot

Insert a disc into the disc slot.



CCP (CENTRAL CONTROLLER PANEL)

The image of this product may be different from the actual product.

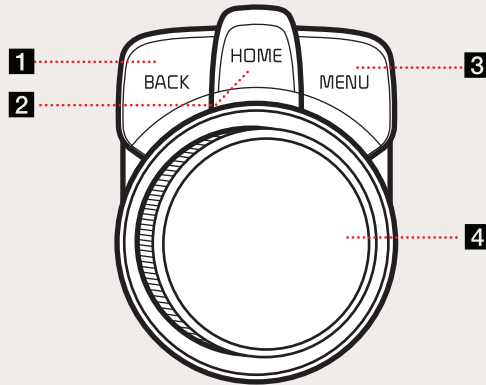

1 BACK button

- Press to move to the previous screen.
- Press and hold to move to the [HOME] menu screen.

2 HOME button

- Press to move to the [HOME] menu screen.
- Press and hold to move to the map screen.

3 MENU button

- Press to move to the pop-up menu in each mode.
- Press and hold to set the split screen.

4 Controller

Tap or rotate to navigate through the menu screens.



RRC (REAR REMOTE CONTROL) - OPTION A

The RRC (Rear Remote Control) function keys differ depending on the selected option, Option A is an operation key that is used with a rear seat monitor (optional). The image of this product may be different from the actual product.

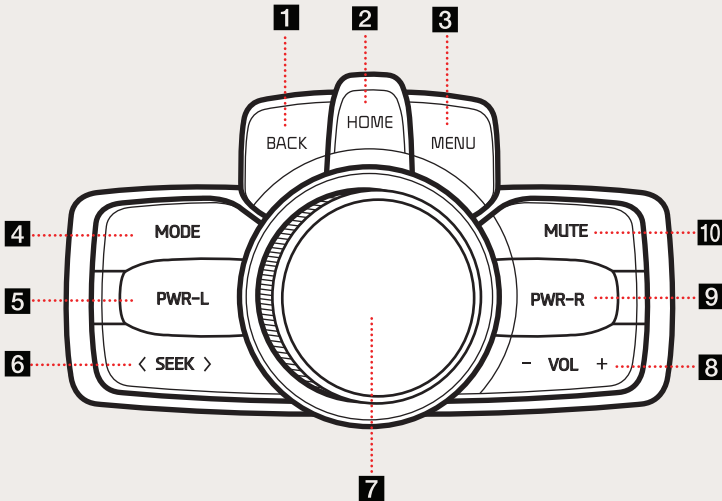

1 BACK button

Press to move to the previous screen.

2 HOME button

Press to move to the [HOME] menu screen.

3 MENU button

Press to move to the pop-up menu in each mode.

4 MODE button

- Each time this button is pressed, the mode is changed.
- If the media is not connected, corresponding modes will be disabled.

5 PWR-L button

- Press to turn the left monitor for rear seat on/off.
- Press and hold this button to turn AV on or off.



6 < SEEK > button

When it is pressed shortly;

- FM/AM mode: plays previous/next frequency.
- SiriusXM mode: plays previous/next channel.
- Media mode: plays previous/next file.

When it is pressed and held;

- FM/AM: changes the frequency until the button is released.
- SiriusXM mode: changes the channel until the button is released.
- Media mode: rewinds or fast forwards the file.

7 Controller

Tap or rotate to navigate through the menu screens.

8 - VOL + button

Increase or decrease the volume level.

9 PWR-R button

- Press to turn the right monitor for rear seat on/off.
- Press and hold this button to turn AV on or off.

10 MUTE button

Press to mute the sound.



RRC (REAR REMOTE CONTROL) - OPTION B

The RRC (Rear Remote Control) function keys differ depending on the selected option. The image of this product may be different from the actual product.

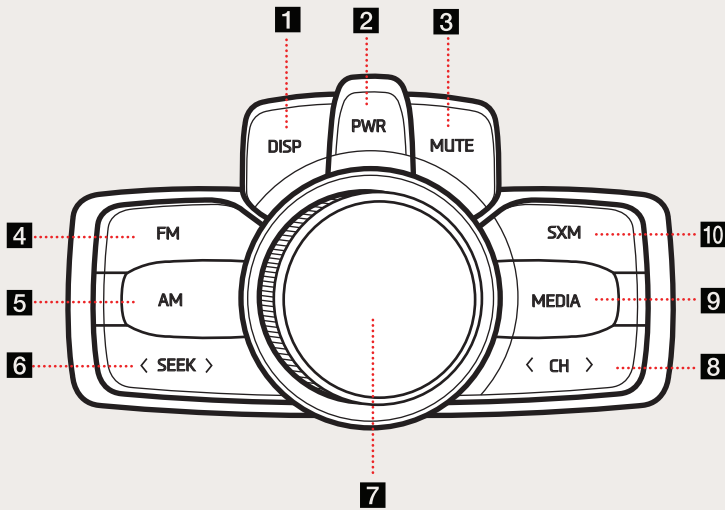

1 DISP button

Press to turn the screen on or off .

2 POWER button

- Power on: Press this button in power OFF status.
- Power off: Press and hold this button in power ON status.
- Press this button to turn AV on or off in power ON status.

3 MUTE button

Press to mute the sound.

4 FM button

Press to select the FM band.

5 AM button

Press to select the AM band.



6 < SEEK > button

When it is pressed shortly;

- FM/AM mode: plays previous/next frequency.
- SiriusXM mode: plays previous/next channel.
- Media mode: plays previous/next file.

When it is pressed and held;

- FM/AM mode: changes the frequency until the button is released.
- SiriusXM mode: changes the channel until the button is released.
- Media mode: rewinds or fast forwards the file.

7 Volume

Turn left/right to control volume.

8 < CH > button

- FM/AM/SiriusXM: Press to select the FM/AM/SiriusXM favorites.
- Media mode: Selects or searches the previous/next item in each mode.

9 MEDIA button

Press to select the media mode.

10 SXM button

Press to select the SXM band.



STEERING WHEEL REMOTE CONTROL

The image of this product may be different from the actual product.

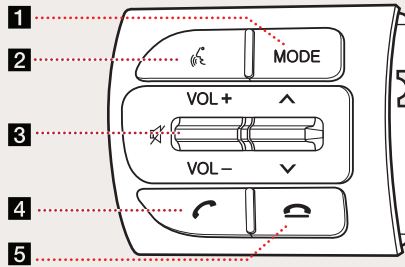

1 MODE button

- Each time this button is pressed, the mode is changed. You can select the accessible media manually from [Mode button (steering wheel)] menu. Only active/available media can be accessed.
- If the media is not connected, corresponding modes will be disabled.
- Press and hold the button to turn the AV on/off.
- When power is off, press the button to turn power back on.

2 button

- Press the button to activate voice recognition mode.
- Press and hold the button to cancel voice recognition.



3 VOL+/VOL- button

Increases or decreases the volume level.

 button

Press to mute the sound.

V / Δ button

When it is pressed shortly;

- FM/AM mode: plays broadcast frequencies saved to favorites.
- SiriusXM mode: plays broadcast channels saved to favorites.
- Media mode: plays previous/next file.

When it is pressed and held;

- FM/AM mode: changes the broadcast frequencies saved to presets until the button is released.
- SiriusXM mode: changes the broadcast channels saved to favorites until the button is released.
- Media mode: rewinds or fast forwards the file.

4 button

When it is pressed shortly;

- Searches new Bluetooth phone or connects the registered phone if Bluetooth is not connected.
- If Bluetooth is connected,
 - Switches to the recent call history screen.
 - When pressed on the dial screen, displays last called number.
 - When pressed on the incoming call screen, answers the call.

When it is pressed and held;

- Searches new Bluetooth phone or connects the registered phone if Bluetooth is not connected.
- If Bluetooth is connected,
 - When pressed on the Bluetooth Hands-Free wait mode, redials the last call.
 - When pressed during a Bluetooth Hands-Free call, switches call back to mobile phone (Private)
 - When pressed while calling on the mobile phone, switches call back to Bluetooth Hands-Free. (Operates only when Bluetooth Hands-Free is connected.)

5 button

- When pressed during a call, ends the phone call.
- When pressed on the incoming call screen, rejects the call.



BASIC OPERATION

SYSTEM ON/OFF

The image of this product may be different from the actual product.

STARTING THE SYSTEM FOR THE FIRST TIME

1. Press the engine start button. Once the system is turned on, the booting process will start and the safety warning page is displayed.



2. Press [Confirm]. If you want to change the system language, press [Language].

! NOTE

- You cannot operate the system while it is booting up. It may take some time for all of features of the system boot up.
- The safety warning page is displayed every time the ignition is turned on. The displayed warnings are related to safety, please closely read and comply with the safety warnings.

TURNING THE SYSTEM OFF

Press and hold [⏻] on the head unit.

To turn the system on again, press [⏻] on the head unit.

! NOTE

Check the volume when turning on the system. Before turning on the system, adjust the volume to a reasonable level.



AV ON/OFF OR VOLUME ADJUSTMENT

AV OFF

Press [⏻] on the head unit when the AV is ON.

AV ON

Press [⏻] on the head unit when the AV is OFF.

ADJUSTING THE VOLUME

Rotate the volume control knob on the head unit.

! NOTE

When you turn the unit off, the current volume level is automatically memorized. Whenever you turn the system on, it operates at the memorized volume level.

RESETTING THE SYSTEM

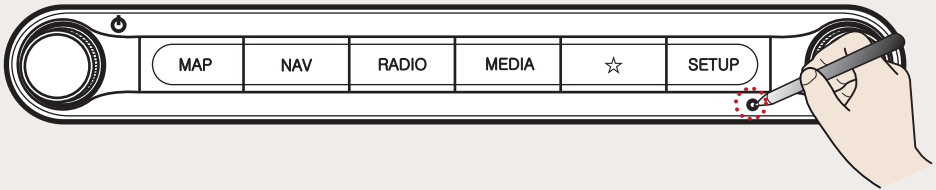

This feature is used to reset the system in the occurrence of an unforeseen error or problem. Press “RESET” button. (The use of a clip or pin is recommended when resetting the system.)



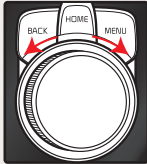
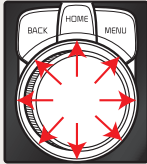

USING THE CONTROLLER

This controller is used to move and select menus.

Controller	Description
	Move in the menu by turning the controller left/right.
	Push the controller up/down/left/right/diagonally to move in the menu.
	Press the controller to select menu.



USING THE TOUCH SCREEN

Press the desired menu on the screen to select a menu.



! NOTE

If you touch the screen while driving, the attention may be scattered and cause a traffic accident. For safety, please use after stopping.



GENERAL OPERATION OF THE MENU IN AVAILABLE MODE

SPLIT SCREEN

This feature is used to set the item to be displayed in the split screen on the right side of the screen by setting a checkmark the [Split screen] menu.

1. Press [Split screen] on the pop-up menu of available mode.

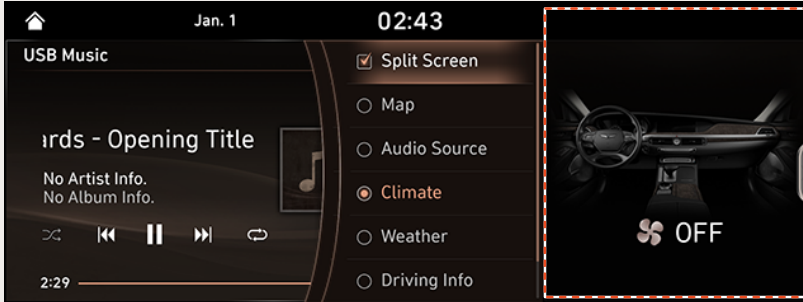

2. Select the desired item.
 - [Split screen]: Selects or cancels the split screen.
 - [Map]: Displays the map screen.
 - [Audio source]: Displays the currently playing media information.
 - [Climate]: Displays the Climate information.
 - [Weather]: Displays the Weather information.
 - [Driving info]: Displays driving information.
 - [Compass]: Displays the compass.



SOUND SETTINGS

This menu is used to adjust the sound effects for the whole system.

1. Press [Sound settings] on the pop-up menu of available mode.

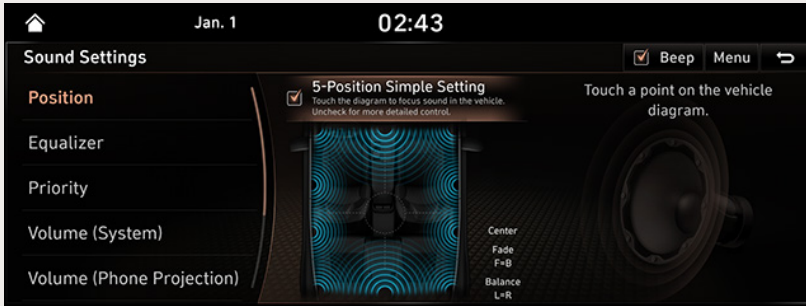

2. For more details, refer to the "Sound" part.

DISPLAY SETTINGS

This menu is used to control the display brightness and image rate for the whole system

1. Press [Display settings] on the pop-up menu of available mode.

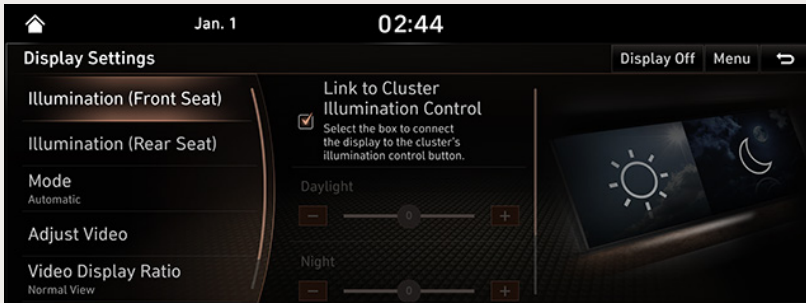

2. For more details, refer to the "Display" part.



SWITCHING TO SIMPLE VIEW OR NORMAL VIEW

1. Press [Simple] on each mode screen. Or press [Menu] > [Simple view].
The simple view screen appears.



<For example: Radio screen>

2. Press [Normal] to move to the normal view. Or press [Menu] > [Normal view].
The normal view screen appears.

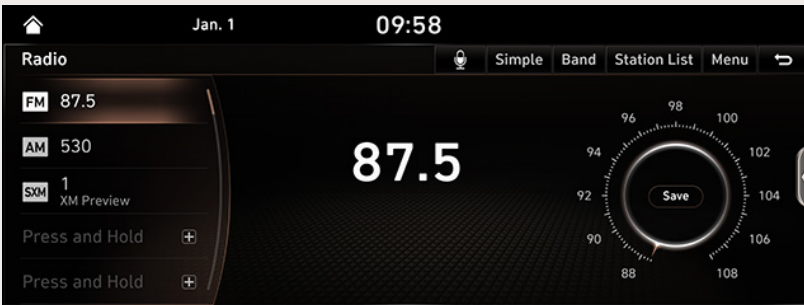

<For example: Radio screen>



HOME SCREEN

BASIC OPERATION OF HOME SCREEN

1. Press [HOME] or . The HOME screen appears.

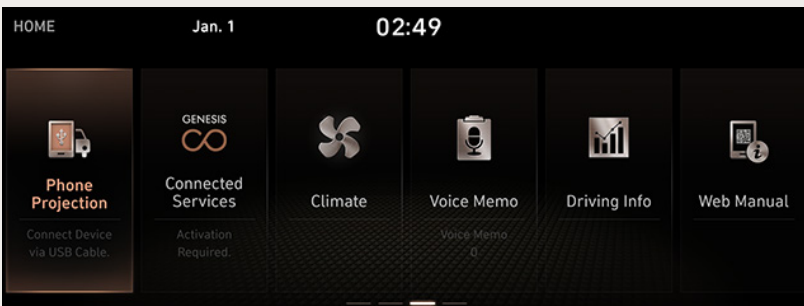
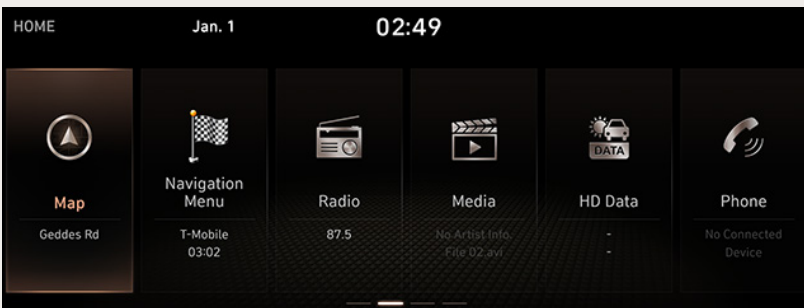

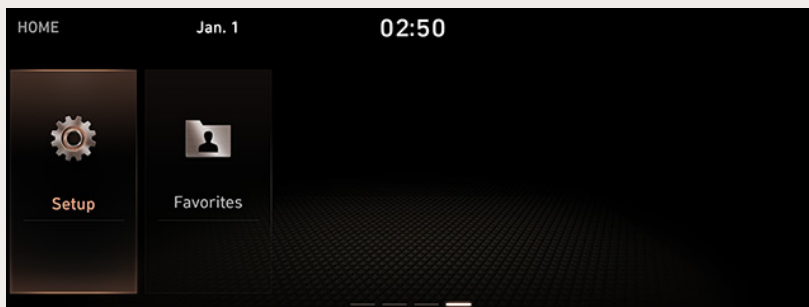

2. Press the desired menu on the HOME screen
3. Subsequent operations will be performed according to the desired menu selection.

CUSTOMIZING HOME SCREEN

You can change the position by pressing and holding the menu icon on the HOME screen.

1. Press and hold the desired menu icon on the HOME screen

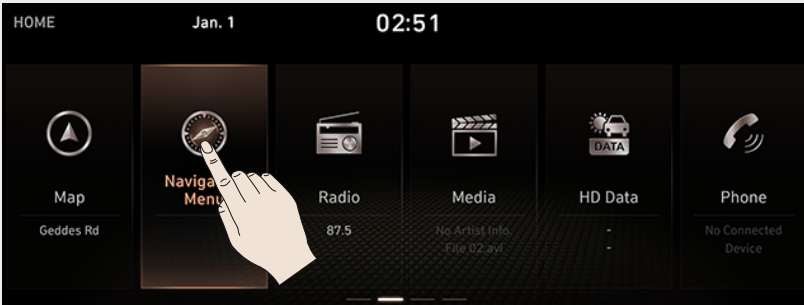

2. Press and drag an item to rearrange the screen.

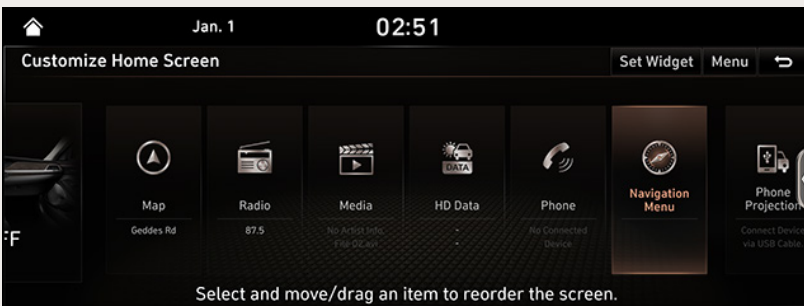

3. Press [HOME] or .



FAVORITES

ADDING YOUR FAVORITE MENU ITEMS TO [FAVORITES] MENU

If your favorite menu items have been already saved in the [Favorites] menu, it can be easily accessed.

1. Press [HOME] or > [Favorites].



2. Press [Add to Favorites].

If your favorite menu items are already added, press [Menu] > [Add].

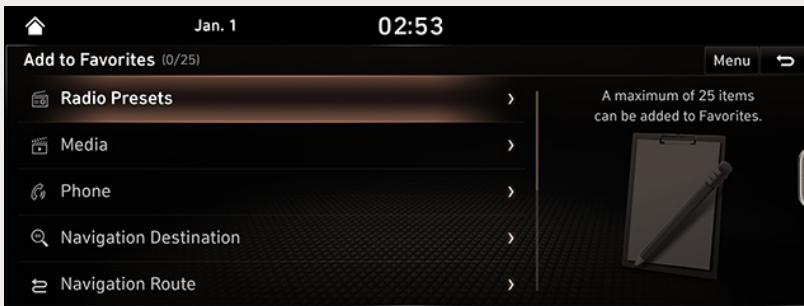



3. Select one of the categories.

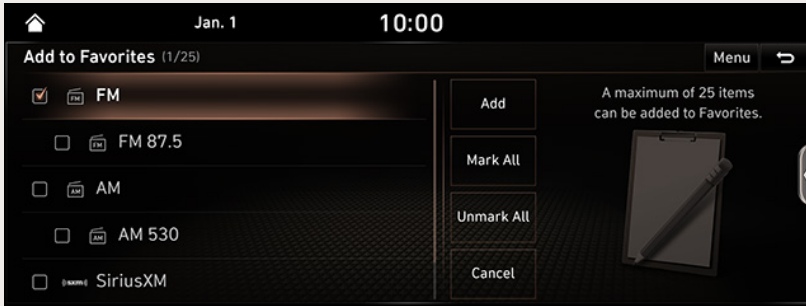

4. Select the desired item.

- [Mark all]: Selects all items.
- [Unmark all]: Unmarks all items.
- [Cancel]: Exits favorites screen.

5. Press [Add].

NOTE

- A maximum of 25 items can be added to [Favorites] menu.
- If you select the menu item added to [Favorites] menu, it moves to the corresponding screen.



REARRANGING YOUR FAVORITE MENU

1. Press [HOME] or  > [Favorites].

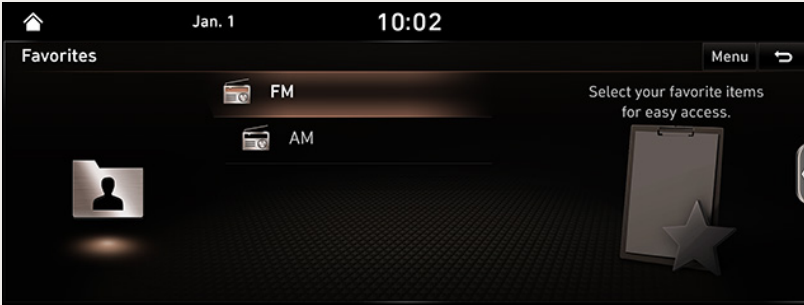

2. Press [Menu] > [Reorder].

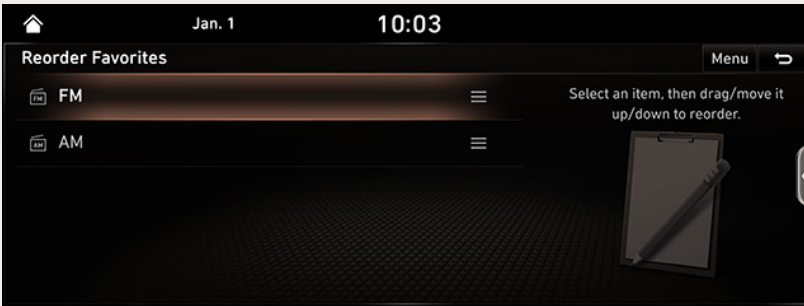

3. Press and hold an item, then move it up/down to rearrange.

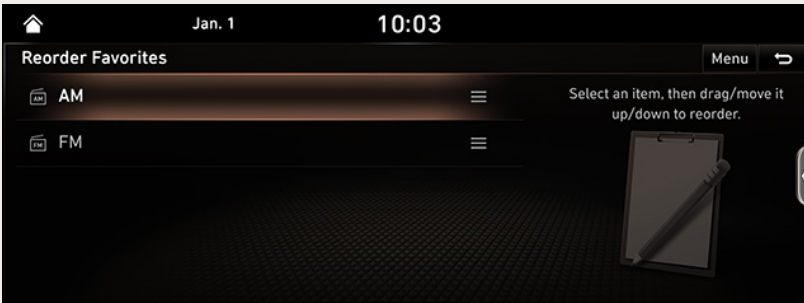



DELETING YOUR FAVORITE MENU

1. Press [HOME] or > [Favorites].



2. Press [Menu] > [Delete].

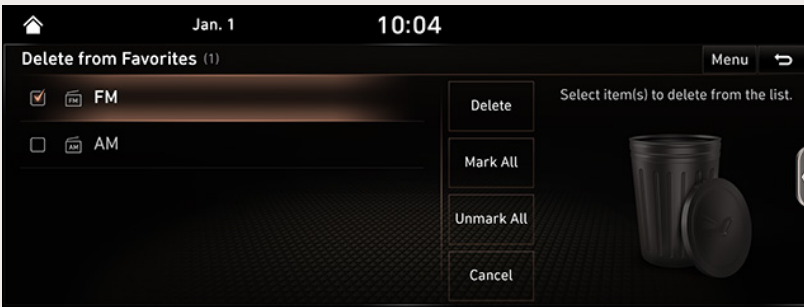

3. Select the desired item, then press [Delete] > [Yes].
 - [Mark all]: Selects all items.
 - [Unmark all]: Unmarks all items.
 - [Cancel]: Exits delete screen.

NAVIGATION





GETTING STARTED WITH NAVIGATION

GENERAL INFORMATION OF NAVIGATION USE

NAVIGATION USE RESTRICTIONS

Please observe and comply with local traffic rules and regulations.

- For your safety, some features cannot be operated while driving. Features that cannot be operated will be disabled.
- The route displayed for destination guidance is a reference and the route guidance will take you to the vicinity of your destination. The highlighted route is not always; the shortest distance, the least congested, and in some cases might, not be the fastest route.
- Road, name, and POI information may not always be completely updated. Some places may not include up to date information.
- The car position mark does not always indicate your exact location. This system uses GPS information, various sensors, and road map data to display the current position. However, errors in displaying your location may occur if the satellite is transmitting inaccurate signals or two or less satellite signals are being received. Errors that occur in such conditions cannot be corrected.
- The position of the vehicle within the navigation may differ from your actual location depending on various reasons, including the satellite transmission state, vehicle state (driving location and conditions), etc. Additionally, the car position mark may differ from the actual position if the map data is different from the actual road landscape, such as changes due to the construction of new roads. If such differences occur, driving for a short period of time will automatically correct the position of the vehicle through map matching or GPS information.



WHAT IS GNSS?

The GNSS(Global Navigation Satellite System) is a satellite-based navigation system made up of a network of 32 satellites placed into orbit by the Global Positioning System (GPS) of U.S.A, GLONASS of RUSSIA, etc.

GNSS works in any weather conditions, anywhere in the world, 24 hours a day.

There are no subscription fees or setup charges to use GNSS.

ABOUT SATELLITE SIGNALS

Your unit must acquire satellite signals to operate. If you are indoors, near tall buildings or trees, or in a parking garage, the unit cannot acquire satellite signal.

ACQUIRING SATELLITE SIGNALS

Before the unit can determine your current position and navigate a route, you must do the following steps:

1. Go outside to an area free from tall obstructions.
2. Turn on the unit. Acquiring satellite signals can take a few minutes.



MAP SCREEN

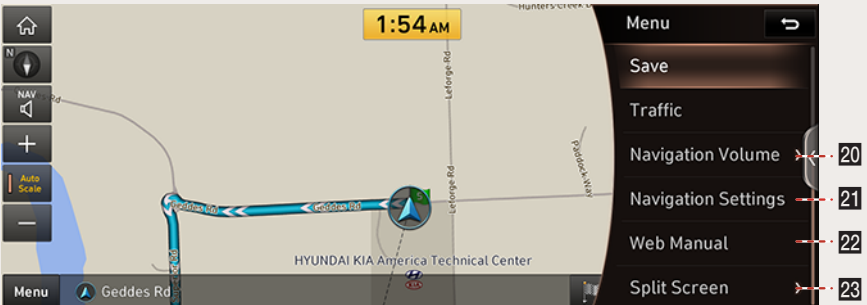
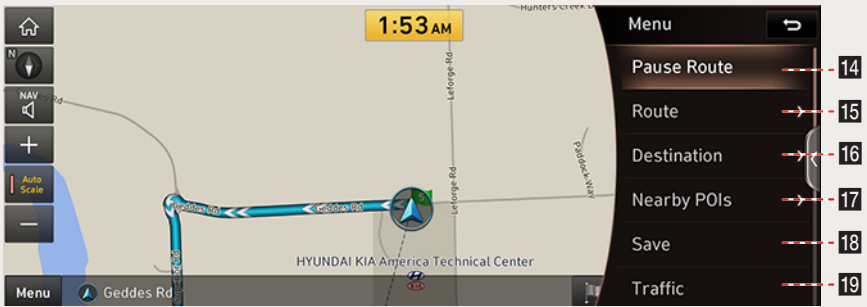
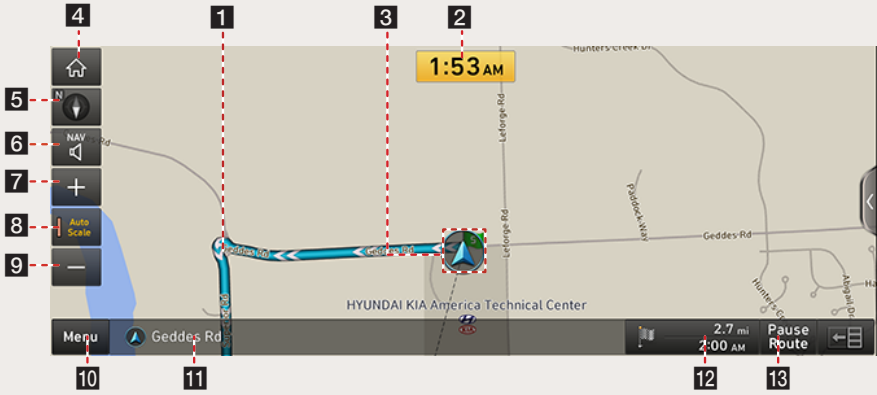



1 Route guidance lane

Displays the route guidance lane to the destination when a route is set.

2 Clock display

Displays current time.



3 Vehicle position mark



Displays current vehicle position and direction.

4 button

Press  to move to [HOME] menu screen.

5 Map display

Changes the map view perspective. Press ,  or .

-  (Heading up (2D)): The map displays always showing the vehicle's direction as proceeding towards the top of the screen.
-  (North up (2D)): The map displays always pointing north, regardless of the direction of the vehicle is moving.
-  (3D) : The map displays always the basic outline and details of the surrounding roads and general area.

6 Navigation Volume

Sets the Navigation Voice guidance Volume.

7 button

Zoom in the map. Press  repeatedly.

8 Map scale display

- Displays the current map scale.
- Sets the zoom level automatically to the guidance.

9 button

Zoom out the map. Press  repeatedly.

10 [Menu] button

Moves to quick menu screen.

**11 Current position**

Displays the current position.

12 Remaining distance display/ Remaining time

Displays the distance and time of arrival to the destination or waypoint. Press to check the information on destination.

13 [Pause Route] button

Pauses the route guidance to the destination or waypoint.

14 [Pause Route] button

Pauses the route guidance to the destination or waypoint.

15 [Route] button

Changes the route conditions when a route is set.

16 [Destination] button

Moves to [Destination] menu.

17 [Nearby POIs] button

Finds a POI (Point Of Interest) near the current position, destination or route.

18 [Save] button

Adds frequently used address to [Address Book] menu.

19 [Traffic] button

Displays the traffic information.

20 [Navigation Volume] button

Adjusts the navigation volume.

21 [Navigation Settings] button

Moves to [Navigation Settings] menu.

22 [Web Manual] button

Displays the QR code for the manual of corresponding function.

23 [Split Screen] button

Sets the item to be displayed on the split screen on the right side of the screen.



OPERATING NAVIGATION

The navigation system displays various information on the screen.

ZOOM IN / ZOOM OUT

- Pinch in/out to set the zoom level on the map screen.
- Turn the controller left/right to set the zoom level on the map screen.
- Press **[+]** or **[-]** to set the zoom level on the map screen.

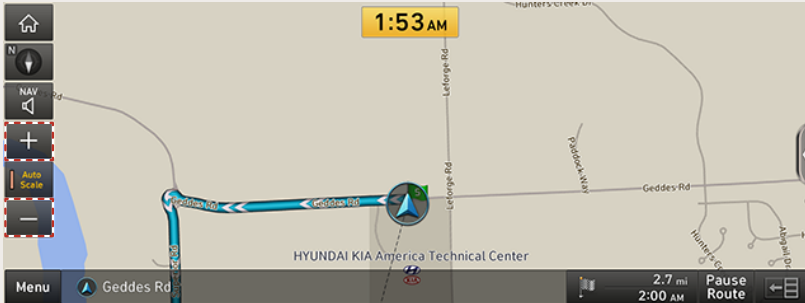

! NOTE

- Press **[+]** or **[-]** for over 1 second. The zoom will continuously change.
- If the zoom range limit is reached, the **[+]** / **[-]** button will be disabled.
- If you want to set the auto zoom, press **[Auto Scale]**.





MAP SCALE

This function sets the zoom level automatically.

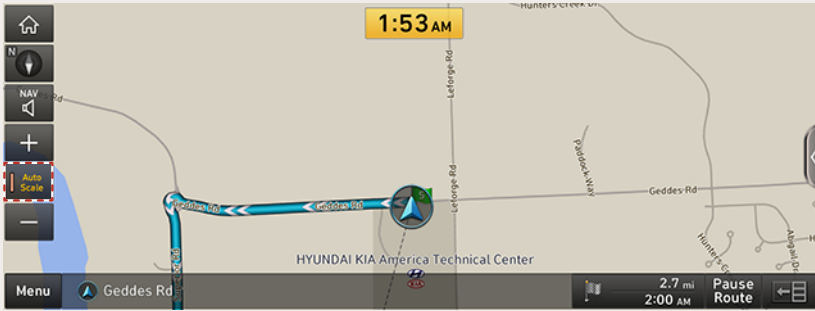
Press  on the map screen.



Name	Description
 Scale Fix (inactive - "Auto")	Fixes the displayed scale.
 Auto Scale (active - "Auto")	Changes the map scale automatically depending on the road class and guidance distance.



MAKING A CALL TO POI

After searching for a POI, the POI phone number information can be used to make a call to the POI facility.

1. Use the various search methods, such as the map scroll function, POI search function, and destination search function to search for a POI.

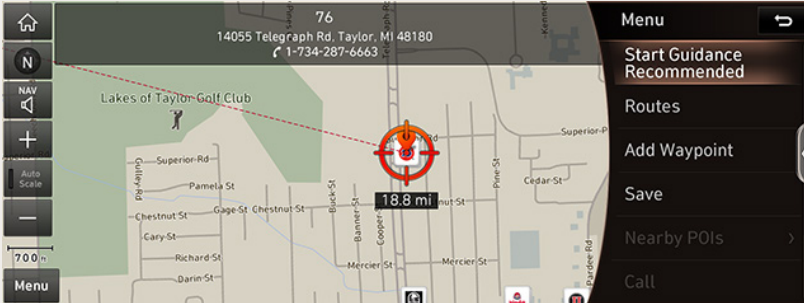

2. Press [Call] on the menu screen.
3. Bluetooth is used to make a call to the POI facility.

! NOTE

Making a call is not possible if there is no telephone information for a POI or if there is no mobile phone connected through Bluetooth.



GUIDANCE TO PREVIOUS DESTINATIONS

When starting the navigation, the “Guidance to Previous Destinations” pop-up appears for about 10 seconds. The pop-up is displayed only when the navigation is started without the route planned.

Press one of the list,

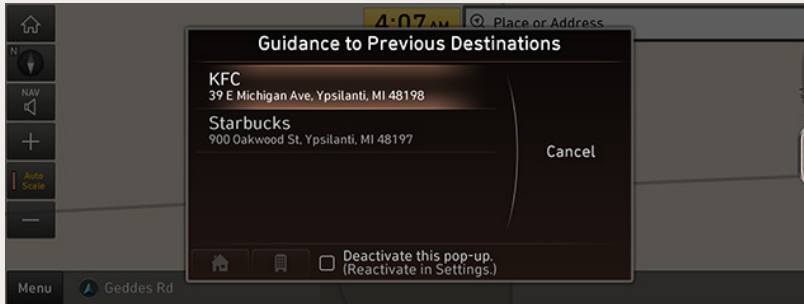

! NOTE

Press [Home] > [Setup] > [Navigation] > [Display] > [Show Previous Destinations after Navigation Start-Up] to set the Guidance to Previous Destinations.

SCROLLING MAP

1. Press and drag the map area on the screen. The selected point will be centered on the screen and the scroll mark will be displayed. Information about the marked point and straight line distance from the current position will be displayed at the center of the screen.

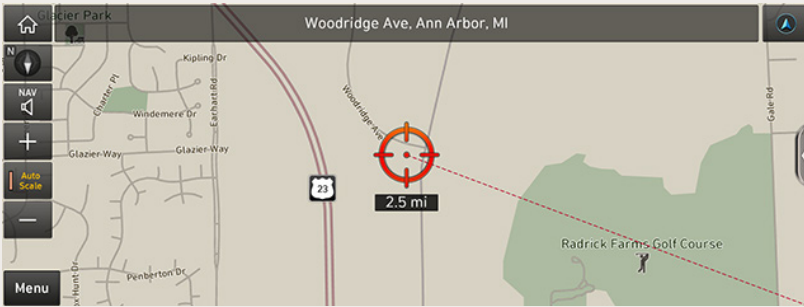

2. Press [Menu] > [Start Guidance].



NAVIGATION MENU

1. Press [Menu] on the map screen.

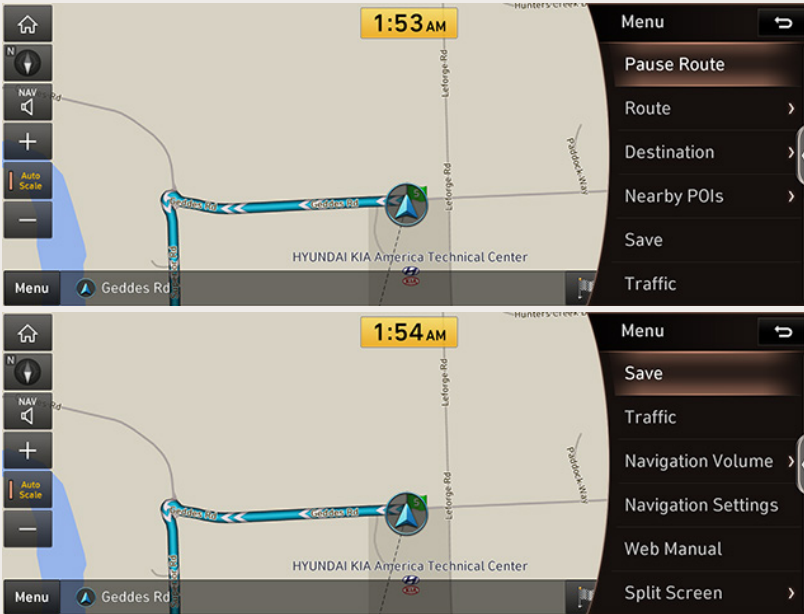

2. Press the preferred setting method.

- [Pause Route]: Pauses the route guidance to the destination or waypoint.
- [Route]: Changes the route conditions by using the [Route] menu when the route is activated.
- [Destination]: Finds a destination by using the [Destination] menu.
- [Nearby POIs]: Finds a facility by searching for POI near current position.
- [Save]: Adds the location to [Address Book] menu.
- [Traffic]: Shows the traffic information list.
- [Navigation Volume]: Adjusts the navigation volume.
- [Navigation Settings]: Sets items related with navigation settings.
- [Web Manual]: Displays the QR code for the manual of corresponding function
- [Split Screen]: Sets the split screen.



SEARCHING FOR POI

POI SEARCH

You can find a POI (Point Of Interest) along route, near current position, near destination, near center of map or near city center.

1. Press [Menu] > [Nearby POIs].

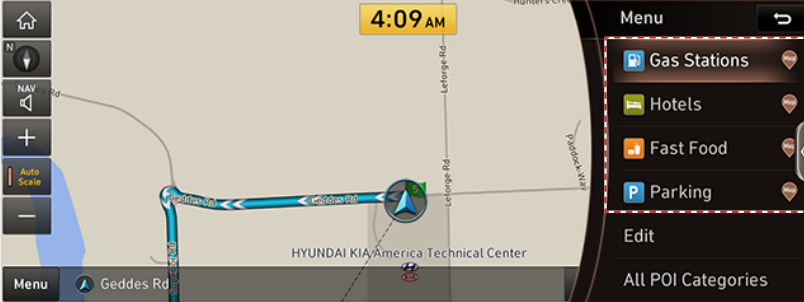

- Press [All POI Categories] to search for all the categories, then select the desired POI.
2. Select one of POI category.

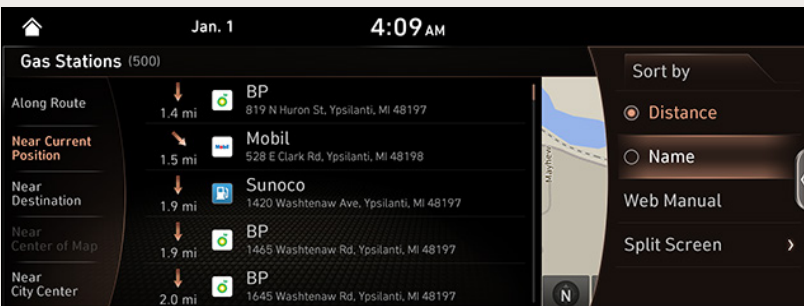
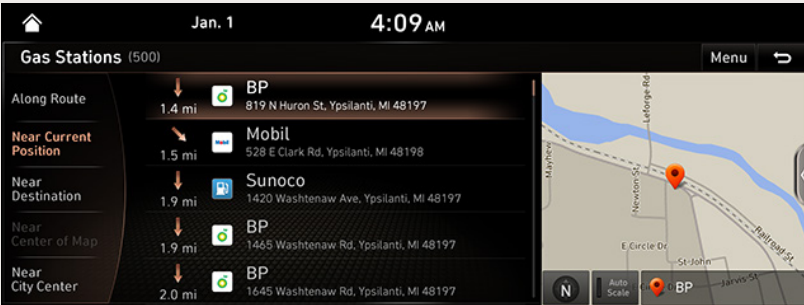

- Press [Menu] > [Name] to arrange the list in name order.
- Press [Menu] > [Distance] to arrange the list in distance order.



3. Press the desired position.

- [Along Route]: Searches for POI's along route when a route is set.
- [Near Current Position]: Searches for POI's around the current position.
- [Near Destination]: Searches for POI's around the destination when a route is set.
- [Near Center of Map]: Searches for POI's around the current cursor when the map scrolled.
- [Near City Center]: Searches for POI's around the city selected.

4. Press the desired item.

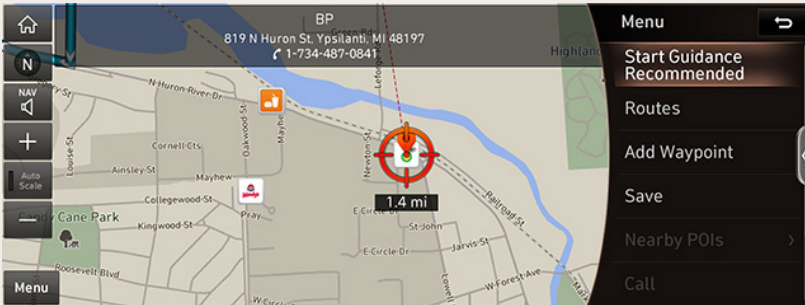

- If you want to set the appropriate route condition according to your purpose, press [Routes].
- If you want to add a waypoint when a route is set, press [Add tourpoint].
- If you want to add the position to [Address book] menu, press [Save].
- If you want to make a call, press [Call].

5. Press [Start Guidance].

! NOTE

The destination is saved in the [Previous Destinations] menu automatically.



DISPLAYING/HIDING POI ICONS ON THE MAP SCREEN

1. Press [Menu] > [Nearby POIs] > [Edit].

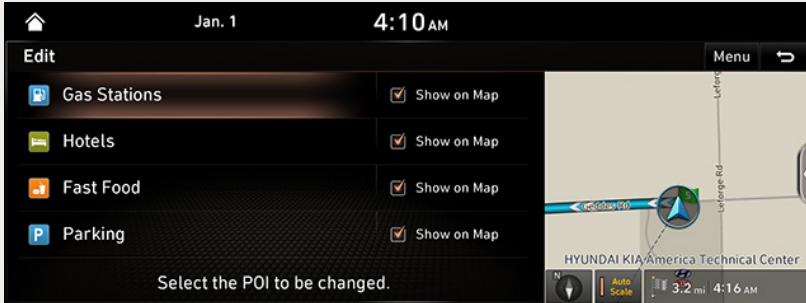

2. Mark or unmark the desired POI. The map icon is displayed on the right of POI menu screen.



EDITING POI CATEGORY

You can edit the POI category displayed on POI menu screen.

1. Press [Menu] > [Nearby POIs] > [Edit].

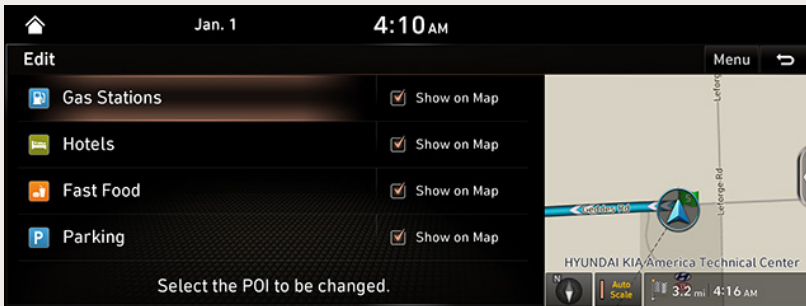

2. Select the POI to edit.

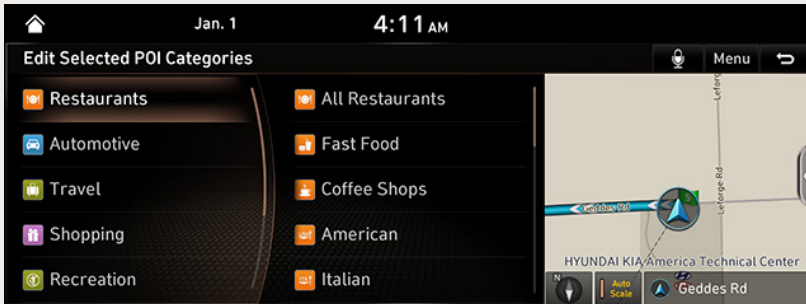

3. Select the desired POI. The selected POI appears on POI menu screen.



ADDING THE POSITION TO ADDRESS BOOK

You can add the current position or the selected place to address book.

1. Press [Menu] > [Save].

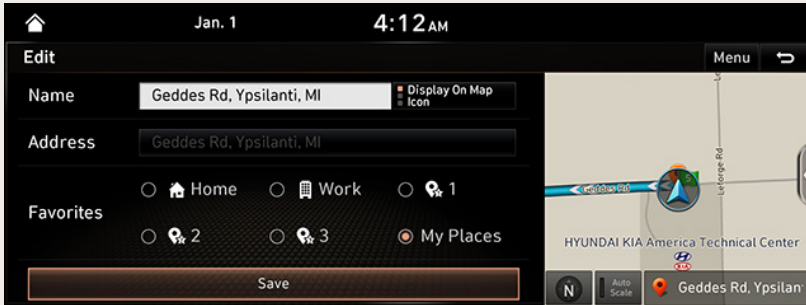

2. Edit the desired item.
 - [Name]: Change the name.
 - [Display on Map]: Press [Icon], [Icon&Name] or [Off] to display on the map screen.
 - [Favorites]: Selects the desired Favorites.
3. Press [Save] to save the setting.

NOTE

Press [Menu] > [Destination] > [Address Book] to check the added position.



TRAFFIC INFORMATION LIST

The current traffic/road event information is basically displayed on the traffic information list.

1. Press [Menu] > [Traffic].

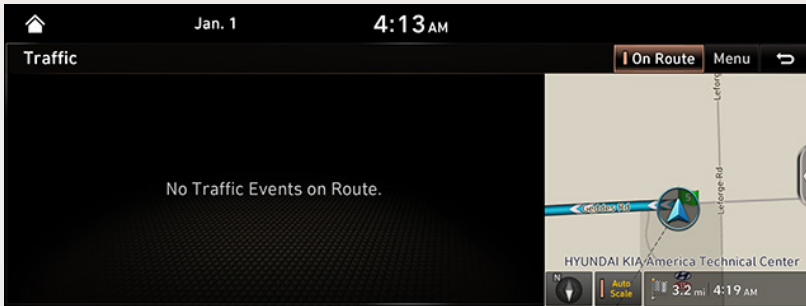

- Press [On Route] to display the traffic information on route when the route is set.
2. Press the traffic list to display the detailed information.

NOTE

This feature may not be reflected depending on condition.



NAVIGATION VOLUME

Press [Menu] > [Navigation Volume] to adjust the volume.

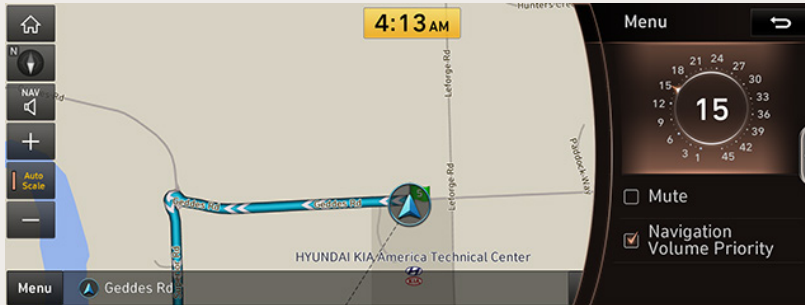

- [Navigation Volume]: Adjusts the navigation volume.
- [Mute]: Sets the sound to mute.
- [Navigation Volume Priority]: Lowers all other audio volumes when navigation guidance is playing.

NAVIGATION SETTINGS

1. Press [Menu] > [Navigation Settings] to set the screen.



2. For more details, refer to the "Navigation" part.



SEARCHING FOR DESTINATION OF NAVIGATION

SEARCH

You can search your destination by name, address or coordinates.

1. Press [Menu] or [NAV] > [Destination] > [Search].

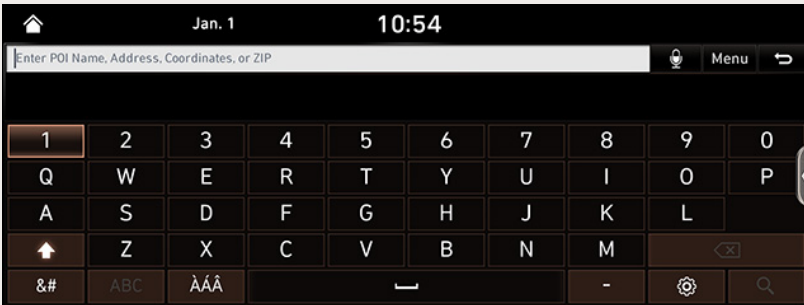

2. Enter the name of the location, address or coordinates and press [Q].
You can change the state by pressing [State].

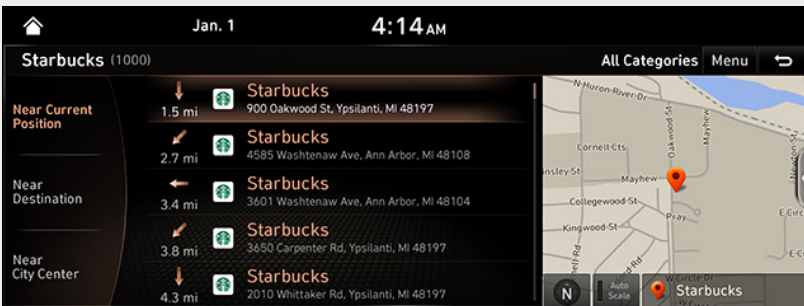



3. Select a location on the map from the list of your search results or filter your search results by city or category.
 - Press [Menu] > [Filter by City] to narrow your search results by city.
 - Press [Menu] > [Filter by Category] to narrow your search results by category.

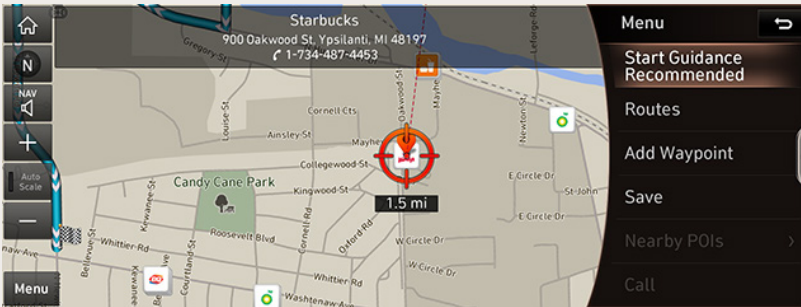

- If you want to set the appropriate route condition according to your purpose, press [Routes].
 - If you want to add a waypoint when a route is set, press [Add waypoint].
 - If you want to add the position to [Address book] menu, press [Save].
4. Press [Start Guidance].

! NOTE

The destination is saved in the [Previous Destinations] menu automatically.



PREVIOUS DESTINATIONS

You can select one of the locations you have previously searched for as a destination, tourpoint and start point.

1. Press [Menu] or [NAV] > [Destination] > [Previous Destinations].

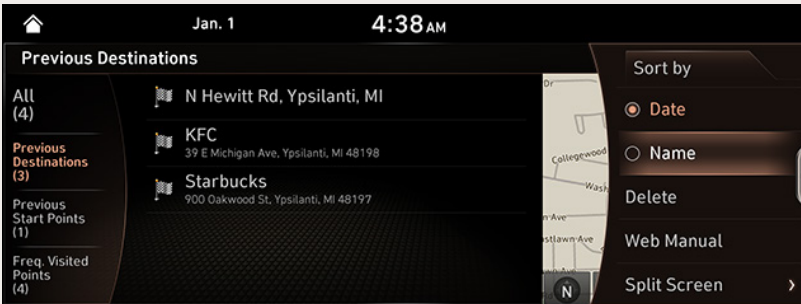
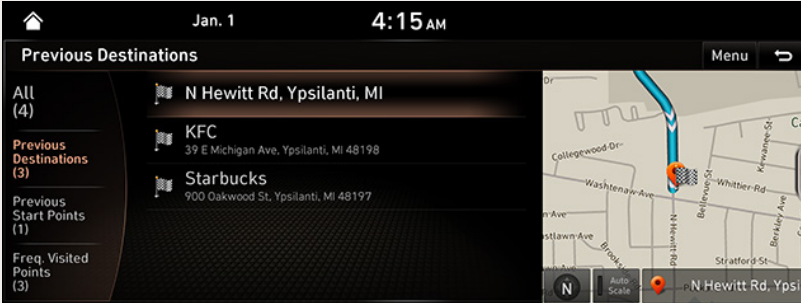

- [All]: Displays all previous destinations, departing places, and searched places.
 - [Previous Destinations]: Displays previous destination places.
 - [Previous Start Points]: Displays previous departing places.
 - [Freq. Visited Points]: Displays frequently visited places.
 - Press [Menu] > [Name] or [Date] to arrange the list in name or date order.
 - Press [Menu] > [Delete] to select and delete items from various entries all at once.
2. Press the preferred previous point from the list.
 3. Press [Start guidance].



ADDRESS BOOK

You can find the destination to a location saved in the [Address Book] menu. To utilize this function more effectively, destinations that you often travel to should be saved in advance. First of all, add a location to the [Address Book] menu through destination search function.

1. Press [Menu] or [NAV] > [Destination] > [Address Book].

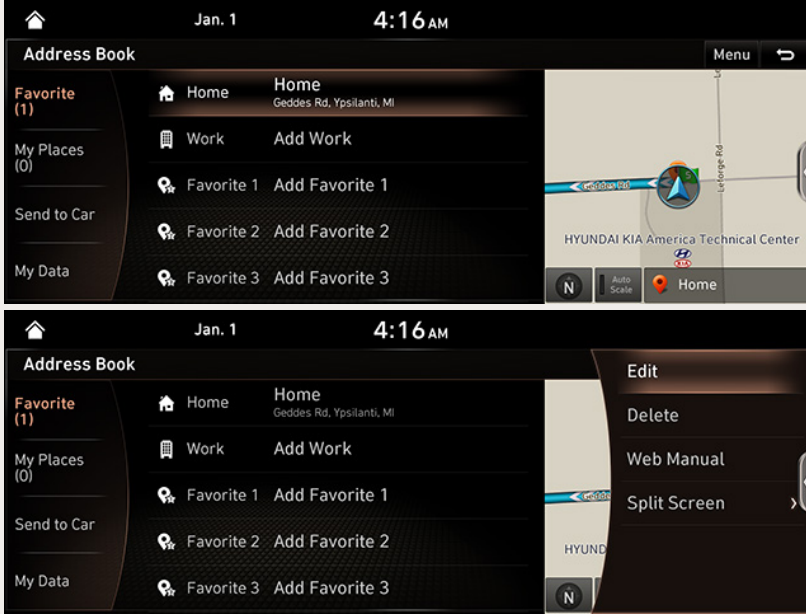

2. Press [Favorites] or [My Places].
 - Press [Menu] > [Date] or [Name] to arrange the list in date or name order.
 - Press [Menu] > [Add] to add a location.
 - Press [Menu] > [Edit] to select and edit an item among many items.
 - Press [Menu] > [Delete] to select and delete items from various entries all at once.
3. Press the desired item from the list.
4. Press [Start guidance].



ADDING TO A LOCATION TO THE [MY PLACES] MENU

1. Press [My Places] in address book list.
2. Press [Menu] > [Add].
3. Select a desired location through destination search function.

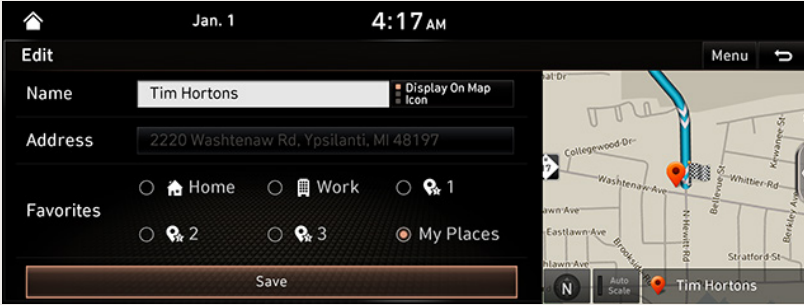

4. Set the desired item.
 - [Name]: Changes the name.
 - [Display on Map]: Press [Icon], [Icon&Name] or [Off] to display on the map screen.
 - [Favorites]: Selects the desired Favorite.
5. Press [Save] to save the setting.



EDITING ADDRESS BOOK

1. Press [Menu] > [Edit] in address book list.
2. Select the item to edit.

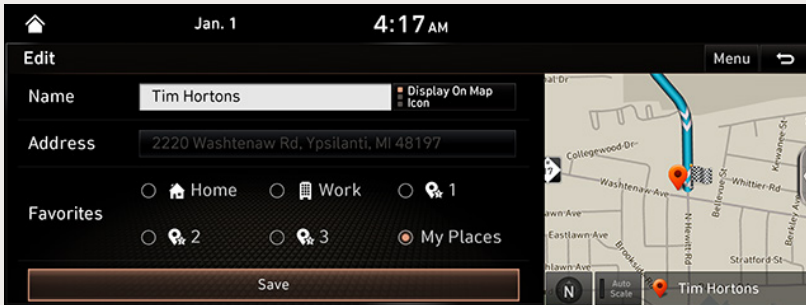

3. Edit the desired item.
 - [Name]: Changes the name.
 - [Display on Map]: Press [Icon], [Icon&Name] or [Off] to display on the map screen.
 - [Favorites]: Selects the desired Favorite.
4. Press [Save] to save the setting.

DELETING ADDRESS BOOK

1. Press [Menu] > [Delete] in address book list.

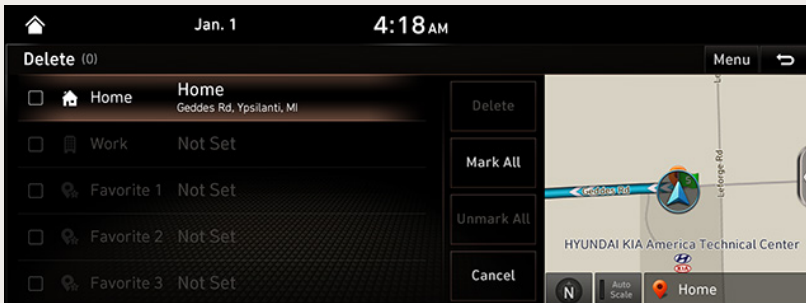

2. Select the desired item, then press [Delete] > [Yes].
 - [Mark All]: Marks all items.
 - [Unmark All]: Unmarks all items.
 - [Cancel]: Exits delete screen.



MY DATA

1. Press [Menu] or [NAV] > [Destination] > [Address Book] > [My Data].

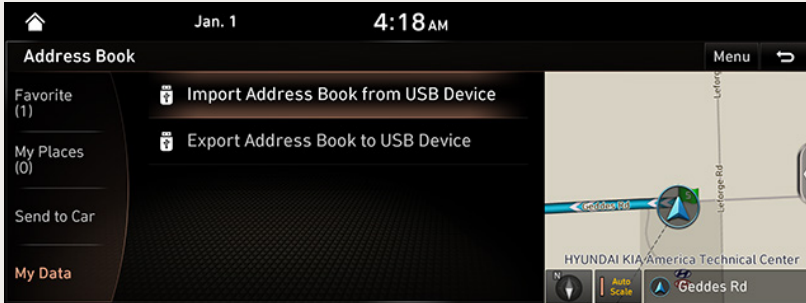

2. Select the desired item.

- [Import Address Book from USB Device]: This function is used to import the address book in the USB device to the navigation system.
- [Export Address Book to USB Device]: This function is used to export the address book in the navigation system to the USB device.

! NOTE

- The amount of data available for importing to a USB device is limited based on the number of address book items supported by the navigation system.
- If the data stored on the USB device uses different coordinates than those used by the current system, the importing location may change.
- Please make sure that the address book have been successfully imported before use.
- Only USB devices formatted in FAT16/32 are supported.
- Certain USB devices may not be supported due to compatibility issues.



POI CATEGORIES

You can find a destination from various categories.

1. Press [NAV] > [Destination] > [POI Categories].

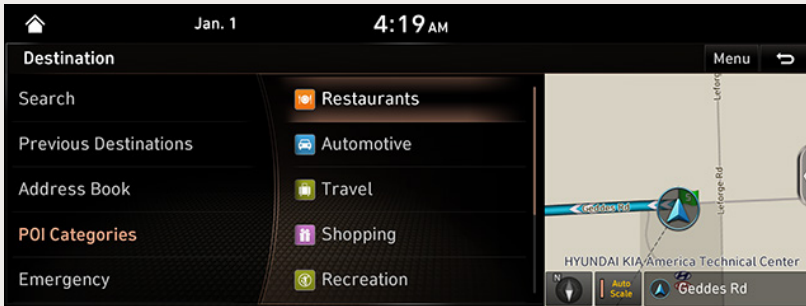

If you want to search for the POI category by history, Press [Menu] > [Category History].

If you want to search for the POI category by name, press [Menu] > [Category Search].

Input the name, then press [Q] to finish.

2. Follow steps 2 to 4 of the "POI search".



EMERGENCY

You can find a destination by searching for a Police Stations, Hospitals, KIA Dealerships or Road Assistance in emergency situations.

1. Press [NAV] > [Destination] > [Emergency] > [Police Stations], [Hospitals], [KIA Dealerships] or [Roadside Assistance].

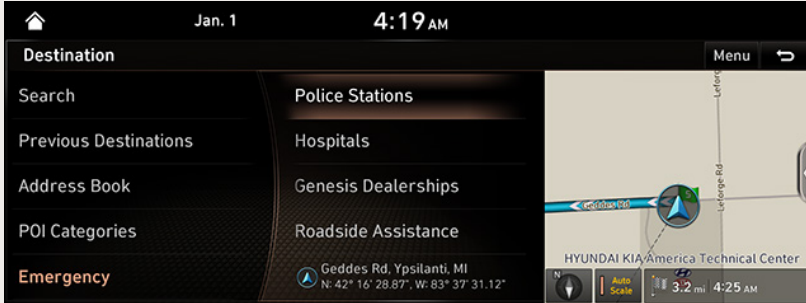

<For example: Police Stations>

- Press [Menu] > [Name] or [Distance] to arrange the list in name or distance order.
2. Press the preferred item from the list.
 3. Press [Start guidance].



HOME / WORK / FAVORITES

If your home location and office location have been already saved in the [Favorites] menu, it can be easily retrieved to set the route to your home location and office location.

First of all, store in the [Favorites] menu through destination search function.

REGISTERING HOME, WORK OR FAVORITE PLACE

1. Press [Menu] > [Destination] > [Add Home] or [Add Work]. Or Press [NAV] > [Destination] > [Address Book] > [Favorites] > [Add Home], [Add Work], [Add Favorite 1], [Add Favorite 2] or [Add Favorite 3].
2. Select the desired position through destination search function.
3. Press [OK] when the destination search is complete. It is saved in the [Favorite] menu automatically.

NOTE

Press [Menu] or [NAV] > [Destination] > [Address Book] > [Favorite] on the map screen to check items saved in the [Favorite] menu.

FINDING YOUR HOME, WORK OR FAVORITE PLACE

1. Press [Menu] > [Destination] > [Home], [Work], [Favorite 1], [Favorite 2] or [Favorite 3].
2. Press [Start guidance].



USING THE ROUTE MENU

CANCEL ROUTE

If you want to stop the route guidance when a route is active, press [NAV] > [Route] > [Cancel Route] or touch and hold [Pause Route].

ROUTE OPTIONS

You can modify the route conditions or confirm the route information. Set the appropriate route condition according to your purpose.

1. Press [NAV] or [Menu] > [Route] > [Route Options].

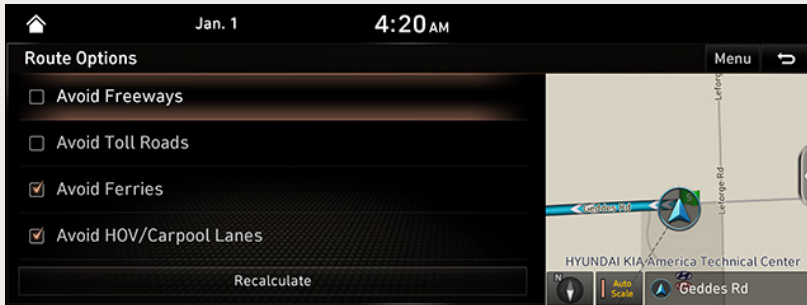

2. Set the desired options.
 - [Avoid Freeways]: Searches for a route that minimizes or avoids the freeway.
 - [Avoid Toll Roads]: Searches for a route that minimizes or avoids toll roads.
 - [Avoid Ferries]: Searches for a route that avoids the use of ferries.
 - [Avoid HOV/Carpool Lanes]: Searches for a route that avoids the use of HOV/Carpool Lanes.
3. Press [Recalculate].

! NOTE

The Items set by user may not be reflected depending on condition.



EDIT ROUTE

This feature allows you to travel through the searched routes by editing the current route. Waypoints can be added/deleted/edited and the order can be changed.

ADDING WAYPOINTS

1. Press [NAV] or [Menu] > [Route] > [Edit Route].

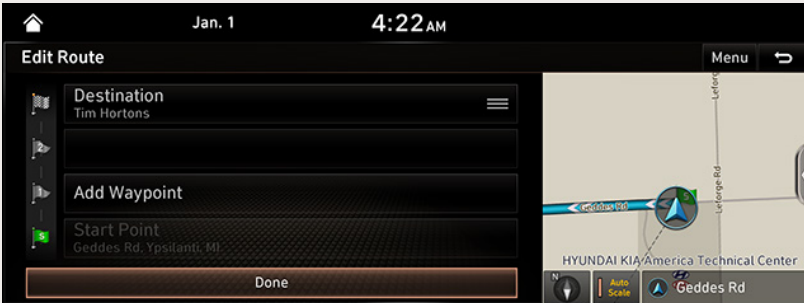

2. Press [Add Waypoint].

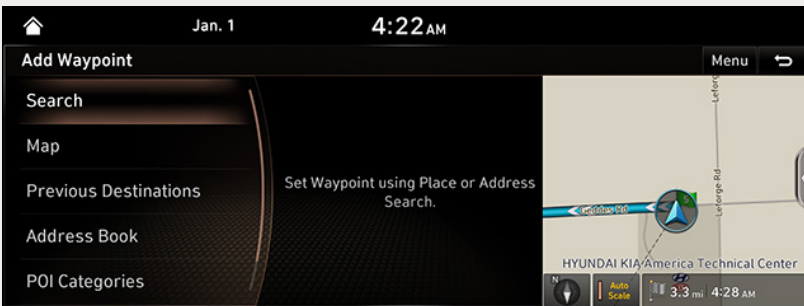

3. Add the waypoint through destination search function.
4. If you want to add an waypoint, follow steps 2~3.
5. Press [Done] > [Start Guidance].



REORDERING ROUTE

1. Press [NAV] or [Menu] > [Route] > [Edit Route].
2. Press the desired item from the list.
3. Drag and drop it to the desired position.
4. Press [Done] > [Start Guidance].

DELETING ROUTE

1. Press [NAV] or [Menu] > [Route] > [Edit Route].
2. Press [Menu] > [Delete].

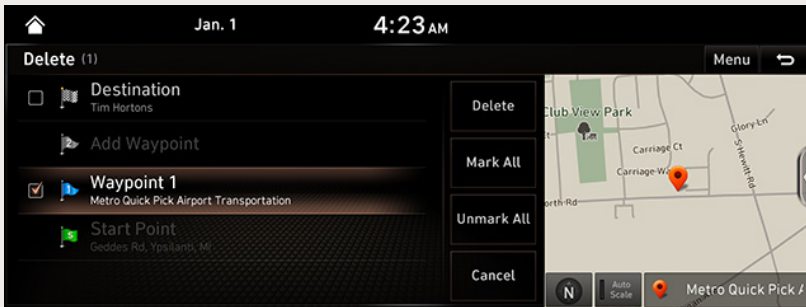

3. Select the desired item, then press [Delete] > [Yes].
 - [Mark all]: Marks all items.
 - [Unmark all]: Unmarks all items.
 - [Cancel]: Exits delete screen.



ROUTE OVERVIEW

You can check the entire route between your current location and your destination.

1. Press [NAV] or [Menu] > [Route] > [Route Overview].

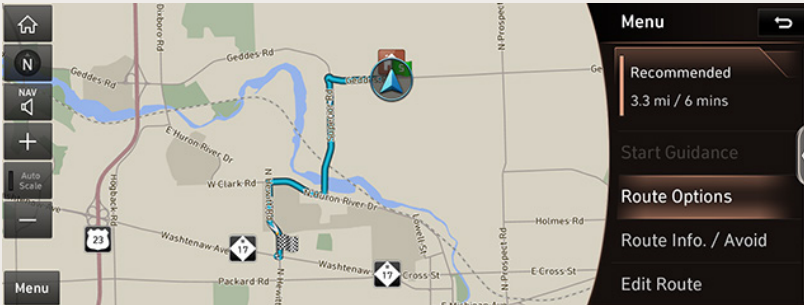

2. Press the desired route.
 - [Recommend]: Calculates the route based on the fastest arrival time.
 - [Alternate]: Calculates the alternate route.
 - [Shorter]: Calculates the route based on the shortest distance.
3. Press the desired item.
 - [Start Guidance]: Starts the route guidance.
 - [Route Options]: Modifies the route options.
 - [Route Info. / Avoid]: Checks the route information and search for new route by avoiding the selected street(s).
 - [Edit Route]: Edits the current routes.



ROUTE INFO. / AVOID

This allows you to check the route information and search for new route by avoiding the selected road(s).

1. Press [NAV] > [Route] > [Route Info. / Avoid].

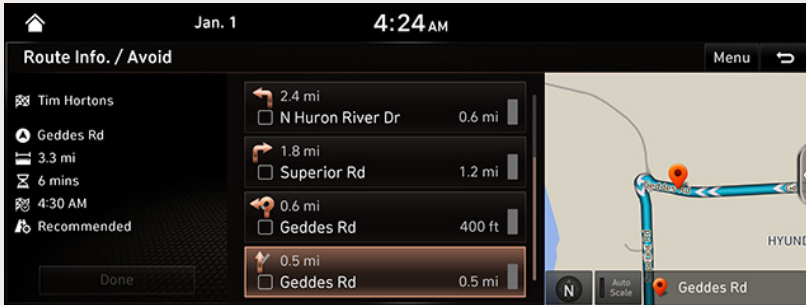

2. Press the checkmark to select the road(s) that you want to avoid.
3. Press [Done] > [Yes].
4. Press [Current] > [Start Guidance].

GENESIS CONNECTED SERVICES





GENESIS CONNECTED SERVICES

The Connected Services function is supported for vehicles purchased in USA.

BEFORE USING CONNECTED SERVICES

WHAT IS CONNECTED SERVICES?

This is a telematics service based on our cutting-edge IT system that makes your driving experience more convenient and fun and features safety, security, vehicle diagnostics, remote control and even smartphone synchronization functions.

Enjoy a smarter driving style with Connected Services.

WHAT IS TELEMATICS?

The word “Telematics” stems from the combination of telecommunications and informatics. It refers to an information system that provides a variety of driving information through the built-in terminal by analyzing each symptom and driving state. This allows for a much safer and more comfortable driving experience.

ABOUT TRANSMISSION AND RECEPTION OF RADIO WAVES

Connection to the Connected Center or wireless data transmission may be disrupted in the following places.

For radio wave transmission/reception status, refer to the status displayed on the Connected Services screen.

It is recommended that you use the Connected Services system when the antenna icon () shows four bars or more.

Places where Connected Services may be disrupted depending on the transmission/reception status:

- Inside tunnels
- Mountainous areas or dense forest
- Roads close to cliff edges
- Densely built-up areas
- On highways or roads underneath higher interchange roads
- Inside buildings



GETTING STARTED WITH CONNECTED SERVICES

Use Connected Services features such as Driving Info and Vehicle Diagnostics. Connected Services features can be used after activating the service. A separate fee may be charged for using Connected Services, and features may differ according to your service plan.

Press [HOME] or  > [Connected Services].

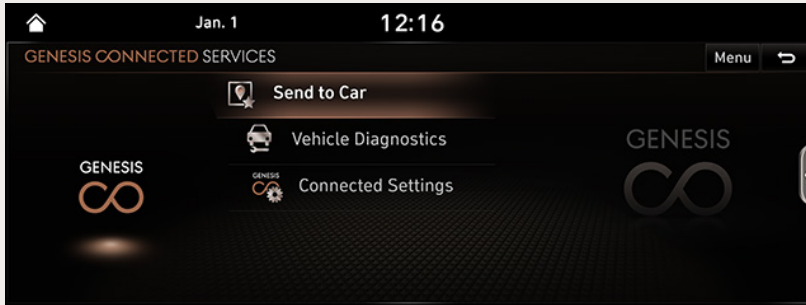



- [Send to Car]: Displays information of Places received by the vehicle from the Connected Services Smart phone application.
- [Vehicle Diagnostics]: Inspects vehicle malfunctions and provides diagnostics.
- [Connected Settings]: Displays Activate Connected Services, Modem Information, and Modem Status.



INTERIOR LIGHT BUTTON

Selecting the Interior light button will allow you to make service required inquiries, place info searches, and emergency rescues by connecting to the Connected Center. Such features can be used only after subscribing to the Connected Services.

Location	Details
	(Connected Services) button Calls or ends the Connected Services call.
	SOS button Calls or ends SOS call. Emergency Rescue Service in Emergency Situation.
	(Voice Local Search) button Request information about places via Voice Local Search.

CONNECTING WITH THE CONNECTED CENTER

Press [∞] on the Interior light button to connect with the Connected Center.

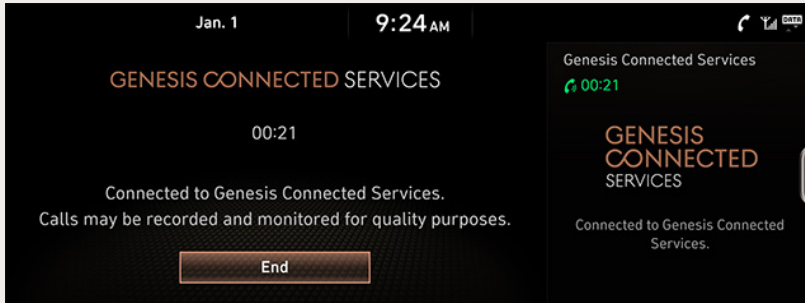



VOICE LOCAL SEARCH

WHAT IS VOICE LOCAL SEARCH?

With Genesis Connected Services network service, you can search for HERE-provided place names with your voice.

Voice local search specializes in place name searches and can be used by pressing the [🗨️] key in the Interior light button.

The search is only available when connected communication network.

STARTING VOICE LOCAL SEARCH

Press [🗨️] key in the Interior light button (less than 0,8 seconds) to start Voice Local Search.

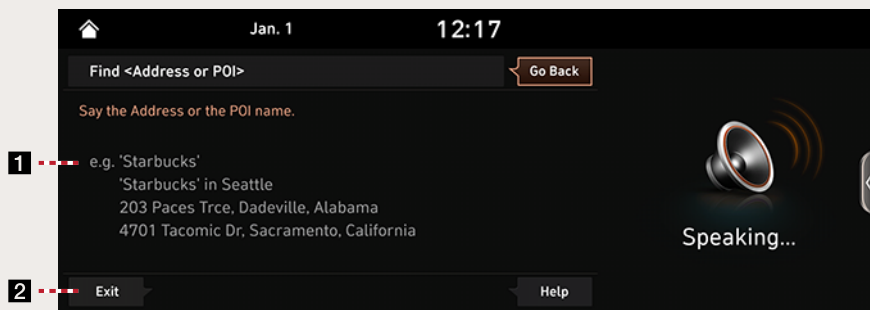

1 Example command

Shows an example to ask for a place search.

2 End

Ends Voice Local Search.

(With Voice Local Search, press [🗨️] key in the Interior light button again to end the service.)

! NOTE

If you change the language set for the system to Korean, French or Spanish, this function will not be supported. Change the system language to other language.



SEND TO CAR

You can check information about Places received via Connected Services Smart Phone application. To use the “Send to Car” function, first you need to sign up to the Connected Services.

VIEW SEND TO CAR

1. Press [HOME] or > [Connected Services] > [Send to Car].

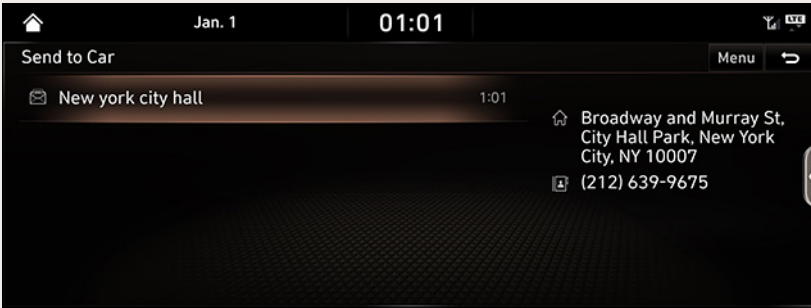

2. Select a desired location from the POI list and Press [Set as Destination] to set the location as the destination, Moves to Set Destination Screen.

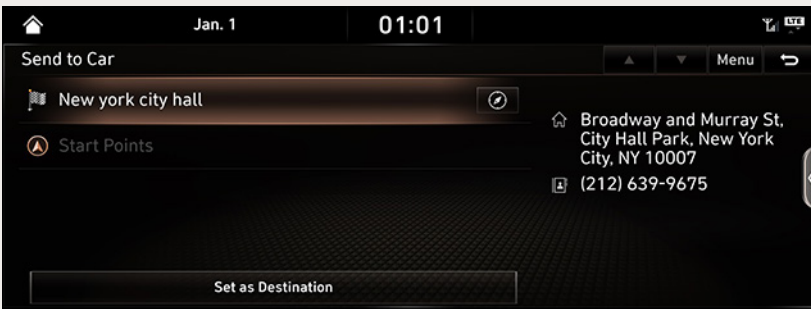

DELETING SEND TO CAR

1. Press [HOME] or  > [Connected Services] > [Send to Car].
2. Press [Menu] > [Delete].

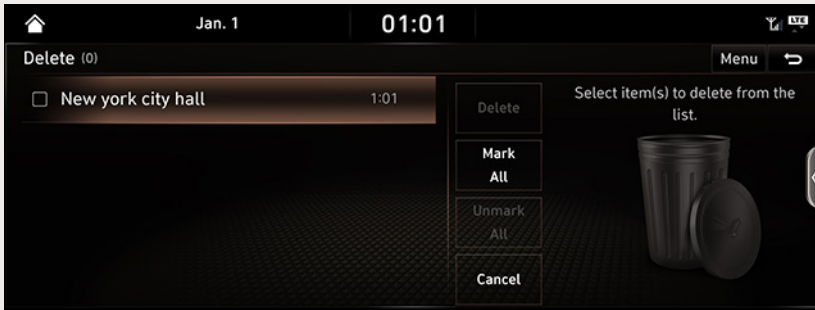

3. Select the desired item(s), then press [Delete] > [Yes].
 - [Mark All]: Selects all items.
 - [Unmark All]: Unmarks all items.
 - [Cancel]: Exits delete screen.



VEHICLE DIAGNOSTICS

Vehicle Diagnostics will be canceled if you switch to another screen while diagnosis is in progress.

To receive result details, you need to first register for Connected Services.

1. Press [HOME] or  > [Connected Services] > [Vehicle Diagnostics].

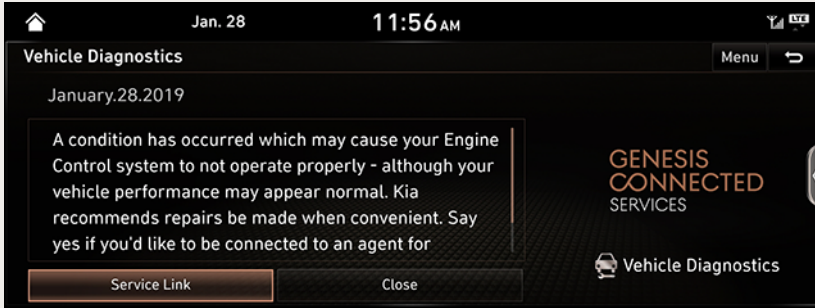

2. Press [Service Link].



CONNECTED SETTINGS

SERVICE ACTIVATION

After you buy your car, you need to activate (register for) Connected Services to use any Connected Services features.

1. Press [HOME] or  > [Connected Services] > [Connected Settings] > [Activate Connected Services].

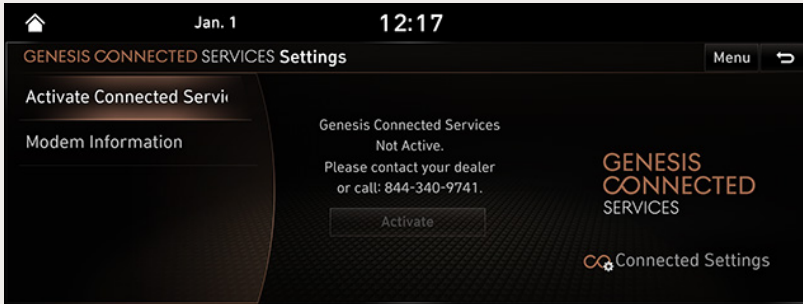

2. Press [Activate].

NOTE

- Activation may take up to five minutes.
- Do not turn the engine off while activation is in progress.
- If activation fails, contact the Connected Center at (844) 340-9741.
- During service activation, the hard keys in the head unit do not work.



MODEM INFORMATION

This feature is used to show the MEID modem information.

Press [HOME] or [] > [Connected Services] > [Connected Settings] > [Modem Information].





CONNECTED SERVICES FEATURES

SAFETY

AUTOMATIC COLLISION NOTIFICATION AND ASSISTANCE

Provides immediate assistance when an accident occurs and an airbag is deployed. In this event, an ACN signal, containing customer and location information, will automatically be transmitted to the response center. Upon receipt of the signal, a response specialist will attempt to establish voice communications with the vehicle occupants and forward any pertinent information to Connected Services emergency services.

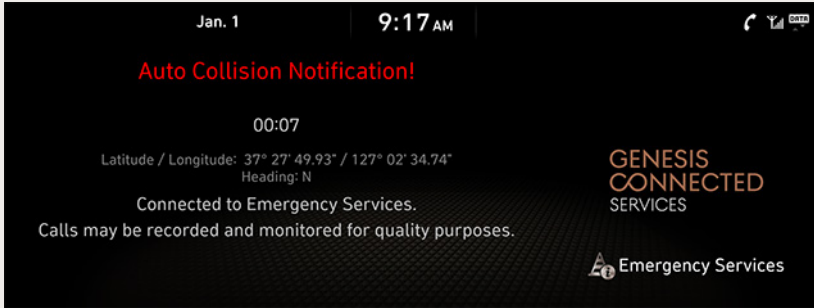

SOS EMERGENCY ASSISTANCE

Customers request emergency Connected Services emergence services by pressing the dedicated [SOS] button in the vehicle. This action transmits vehicle information and location to specially trained response specialists, who assist in coordinating the dispatch of appropriate emergency assistance to the customer.

The response specialist remains on the line with the customer until advised assistance has arrived.





CAR CARE

MONTHLY VEHICLE HEALTH REPORT

You can begin receiving a comprehensive diagnostic evaluation involving most aspects of your vehicle's performance (e.g., systems check, mileage attained, upcoming maintenance, etc.).

AUTOMATIC DIAGNOSTICS TROUBLE CODE NOTIFICATION

When owners receive a vehicle trouble code notification, this feature provides an explanation. Through a combination of in-vehicle display alerts and guided voice messages, the owner will learn what to do next. This information is automatically sent to the owner's preferred dealer to assist with the repair process.

MAINTENANCE ALERT

This feature helps you keep your vehicle in optimum running order by notifying you in advance of regularly scheduled maintenance intervals. Notification is made via your choice of text messaging or email.



REMOTE SERVICE

REMOTE DOOR LOCK/UNLOCK

With this feature, you can lock or unlock your vehicle doors from virtually anywhere by using the Genesis Connected Services Mobile Apps, or using the Genesis Connected Services Owner's website.

REMOTE HORN/LIGHTS

When the parking spot in the parking lot of a hotel or mart is forgotten, the spot can be checked by the bilking lights and the horn sound.

REMOTE START WITH CLIMATE CONTROL

This feature enables you to remotely start your vehicle and set an engine timer (1-10 minutes) from virtually anywhere. You can also set the climate control temperature and turn on the front-window defroster, ensuring a warm or cool car is ready to go when you are.

CAR FINDER

The mobile app feature enables you to find your vehicle on a map.



VEHICLE SAFEGUARD

STOLEN VEHICLE RECOVERY

In the event a customer's vehicle is reported stolen (and a stolen vehicle report has been filed with the appropriate police department), the response center can provide assistance to the police in an attempt to recover the vehicle.

VEHICLE SLOWDOWN

Used with Stolen Vehicle Recovery, this enables law enforcement to gradually reduce the engine power of the vehicle, thus slowing it down to safe levels. A warning shall be transmitted to the driver prior to the slowdown procedure.

VEHICLE IMMOBILIZATION

Used with Stolen Vehicle Recovery, this enables law enforcement to send a signal to the vehicle which immobilizes the engine management system, thus preventing startup. This capability is only valid when the ignition is off, but can be saved for later immobilization if the vehicle is on or in motion at the time of signal transmission.

PANIC NOTIFICATION

This feature will notify any pre-selected persons of your vehicle's precise location if your vehicle's remote panic button is engaged, via your choice of text messaging or email.

ALARM NOTIFICATION

In the event your vehicle's alarm is activated, this feature will automatically notify any pre-selected persons via your choice of text messaging or email.



VALET ALERT

Whenever you leave your vehicle with a valet and it travels farther than your pre-selected distance boundary after activation, you will be notified in-vehicle and via your choice of text message or email.

GEO FENCE ALERT

This feature allows you to designate the boundaries of areas in which your vehicle may and may not be driven. Should the vehicle cross these boundaries, you will be notified in-vehicle and via your choice of text messaging or email.

SPEED ALERT

This feature allows you to pre-set a speed limit for your vehicle. Should the speed limit be exceeded, you will be notified in-vehicle and via your choice of text messaging or email.

CURFEW ALERT

This feature allows you to pre-set acceptable time intervals for when your vehicle can and cannot be driven. Should these be exceeded, you will be notified in-vehicle and via your choice of text messaging or email.

DRIVER ASSISTANCE





DRIVER ASSISTANCE

Driving assistance system that helps you drive in speed you want, keeping distance from the car ahead.

01_SCC

Driving assistance system that helps you drive in appropriate speed on the highway using navigation.

02_NSCC

Driving assistance system that helps you drive in appropriate speed on the middle of the highway, keeping distance from the car ahead.

03_HDA

Driving assistance system that helps you keep the lane you are driving on.

04_LFA

Driving safety system that warns you off the danger of collision and helps you avoid.

05_FCA

Driving safety system that warns when you get out of the lane and helps you keep you lane.

06_LKA

1. Press [HOME] or > [Setup] > [Vehicle] > [Driver Assistance].

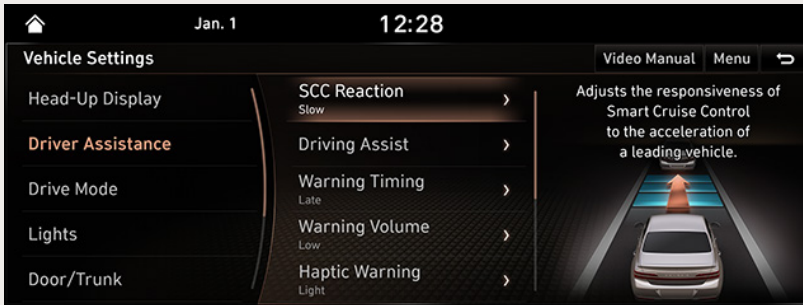

2. Select the desired items.

SCC REACTION

It adjusts the responsiveness of Smart Cruise Control to the acceleration of a leading vehicle. Select [Fast], [Normal], or [Slow].

DRIVING ASSIST

You can set the assistant items related to driving safety when driving.

- [Leading Vehicle Departure Alert]: Notifies the driver when the leading vehicle drives away.
- [Lane Following Assist]: Automatic adjustment of the steering to keep the vehicle centered in the lane.
- [Highway Driving Assist]: Enables Highway Driving Assist which provides lane keeping, smart cruise, and sets vehicle speed automatically according to the expressway speed limit.



- [Highway Auto Speed Zone Slowdown]: Automatic deceleration before entering motorway speed enforcement zones.
- [Highway Auto Curve Zone Slowdown]: Automatic deceleration before entering a curvy zone on motorways.

WARNING TIMING

This menu is used to select the warning timing of the driver assistance systems. Select [Normal] or [Late].

WARNING VOLUME

This menu is used to adjust the warning sound volume of the driver assistance systems. Select [High], [Medium], [Low], or [Off].

HAPTIC WARNING

This menu is used to adjust the intensity of steering wheel haptic warning for driving safety systems. Select [Strong], [Medium], or [Light].

DRIVER ATTENTION WARNING

This menu is used to warn the driver inattentiveness and recommend of a reset if needed. Check [Attention Warning].

FORWARD SAFETY

You can set the forward safety function.

- [Active Assist]: Collision avoidance by provision of a warning and vehicle control when a risk of forward collision is detected.
- [Warning Only]: Warning on detection of a risk of forward collision.
- [Off]: Turns off the forward safety function.

LANE SAFETY

You can set the lane safety function.

- [Lane Keeping Assist]: Automatic adjustment of the steering wheel to keep the vehicle in the lane when approaching the lane markings.
- [Lane Departure Warning]: Warning, when the vehicle leaves the lane.
- [Off]: Turns off the lane safety function.



BLIND-SPOT SAFETY

You can set the properties of Blind-spot safety functions.

- [Blind-Spot view]: Displays the blind spots view in the cluster when changing the lanes using the turn signal.
- [Safe Exit Assist]: It helps to get off safely from the vehicle by detecting traffic in the blind spot and providing a warning and exit control.
- [Active Assist]: Collision avoidance by providing a warning and vehicle control when a risk of blind spot collision is detected.
- [Warning Only]: Warning when risk of blind-spot collision is detected.
- [Off]: Turns off the blind-spot safety function.

PARKING SAFETY

You can set parking distance warning, collision avoidance assistance, collision warning during parking.

- [Parking Distance Warning Auto ON]: Automatically activates Parking Distance Warning when traveling at low speeds.
- [Rear Cross-Traffic Safety]: Assists in collision avoidance by providing a warning and vehicle control when a risk of rear cross-traffic collision is detected while backing up.
- [Active Assist]: Assists in collision avoidance by providing a warning and vehicle control when a risk of collision is detected while backing up.
- [Warning Only]: Provides a warning when a risk of collision is detected while backing up.
- [Off]: Disables the Parking Safety function.

DATA SERVICES





ABOUT HD DATA SERVICES

The HD Data is a paid membership satellite radio service which provides users with traffic, weather, doppler radar, and fuel prices information.

ACCESSING HD DATA SERVICES

Press [HOME] or [] > [HD Data].



<HD Data screen>



TRAFFIC

The current traffic/road event information is basically displayed on the traffic information list.

1. Press [HOME] or > [HD Data] > [Traffic].

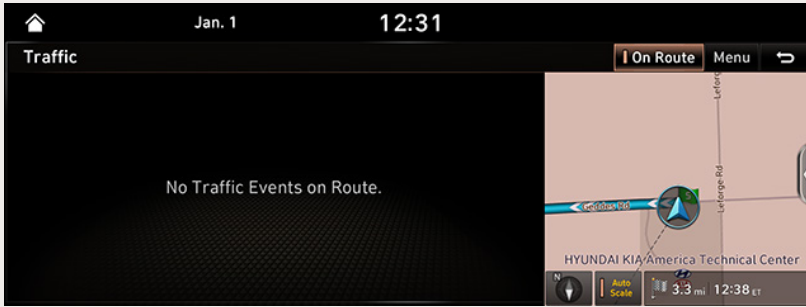

- Press [On Route] to display the traffic information on route when the route is set.
 - Press [Menu] > [Category] or [Distance] to sort in Category or Distance order.
 - Press [Menu] > [Category] to search for category. You can check the related information by marking various information (Accidents, Road Construction, etc).
2. Press the traffic list to display the detailed information.

NOTE

This feature may not be reflected depending on condition.



WEATHER

This service provides current weather information in your region when the vehicle is within regions where HD Radio signals can be received.

1. Press [HOME] or > [HD Data] > [Weather].

This current weather information is displayed on the screen.

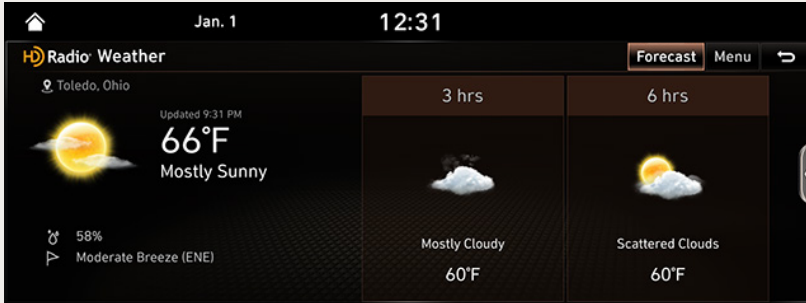

2. Press [Forecast] to check weather forecasts for the next five days including today in your region. Or press [Menu] > [Forecast].

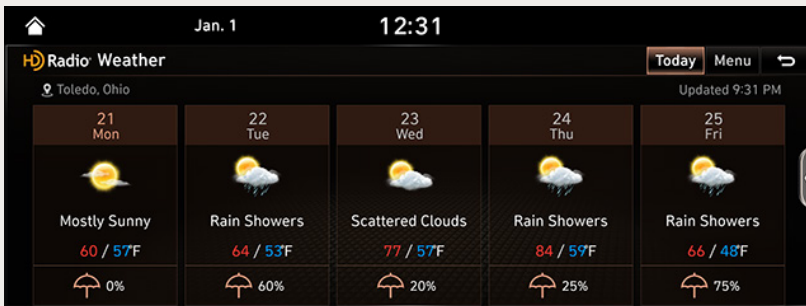

Press [Menu] > [Location List] to check weather information in other region.

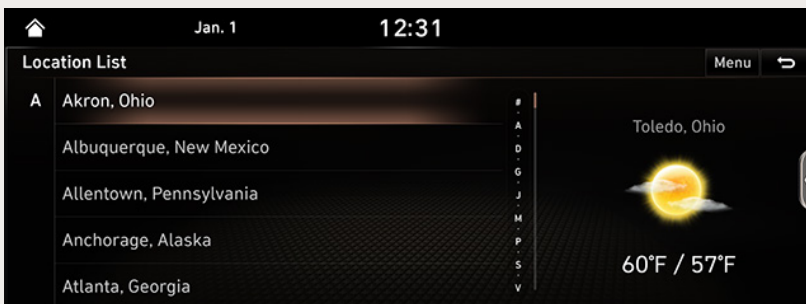



DOPPLER RADAR

This service provides Doppler Radar information in your region, when the vehicle is within regions where HD Radio signals can be received.

Press [HOME] or > [HD Data] > [Doppler Radar].

This Doppler Radar information is displayed on the screen.

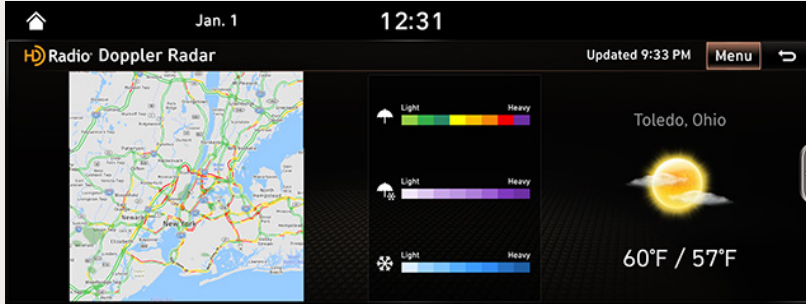



FUEL PRICES

FINDING GAS STATION

1. Press [HOME] or > [HD Data] > [Fuel Prices]. This Fuel Prices list is displayed on the screen.

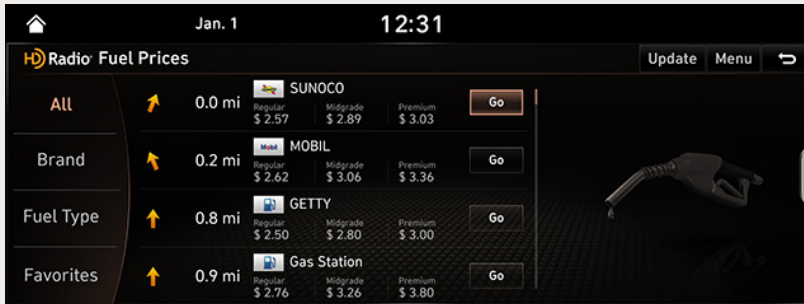

<Fuel Prices list>

- [All]: Displays all gas stations.
 - [Brand]: Displays gas stations by brand.
 - [Fuel Type]: Displays gas stations by fuel type.
 - [Favorites]: Moves to the [Favorites] menu.
 - Press [Menu] > [Sort by] > [Distance], [Price], [A - Z] to sort in Distance, Price, or Alphabetical order.
 - Press [Menu] > [Search] to search for the gas station.
2. Press [Go] > [Start Guidance].

NOTE

- Within 50 miles, a maximum of 250 items can be displayed.
- Press [Update], to display the added Fuel Prices list.



SEARCHING FOR GAS STATION

1. Press [Menu] > [Search] in Fuel Prices list.
2. Enter the desired gas station and press .

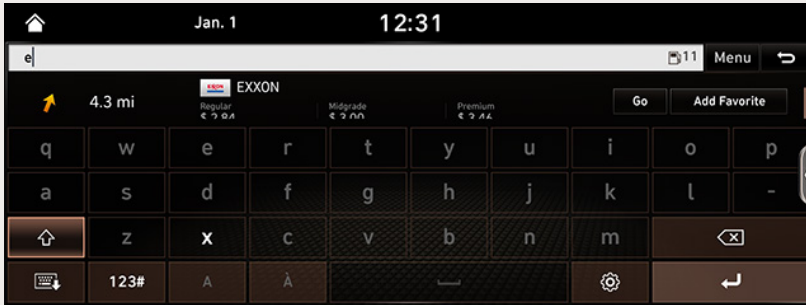

3. To store the desired item as a favorite, press [Add Favorite].

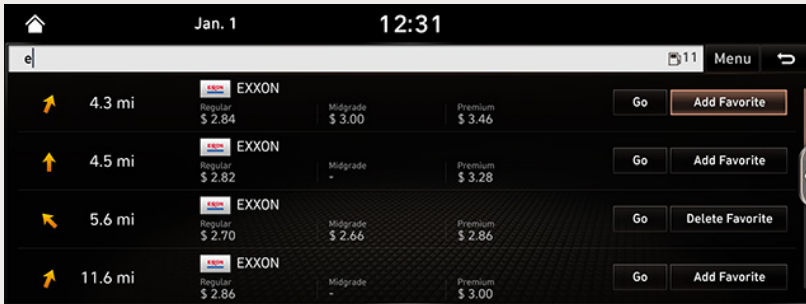

4. Press [Go] > [Start Guidance].



FAVORITES

If the gas station has been already stored in the Favorites, it can be easily recalled. First of all, add the gas station in the Favorites.

1. Press [Favorites] in Fuel Prices list.

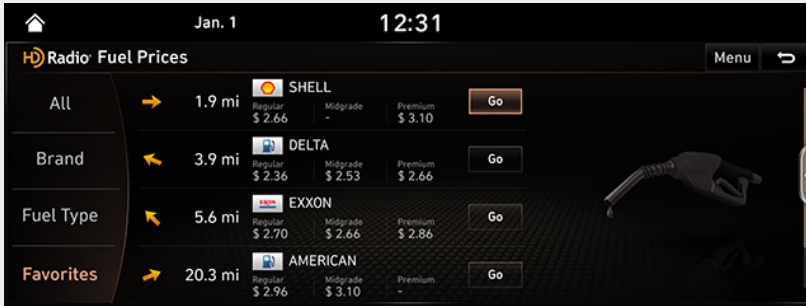

2. Press [Go] > [Start Guidance].

ADDING TO FAVORITES

A maximum of 10 items can be added.

1. Press [Favorites] > [Menu] > [Add Favorite] in Fuel Prices list.
2. Enter the desired gas station and press .

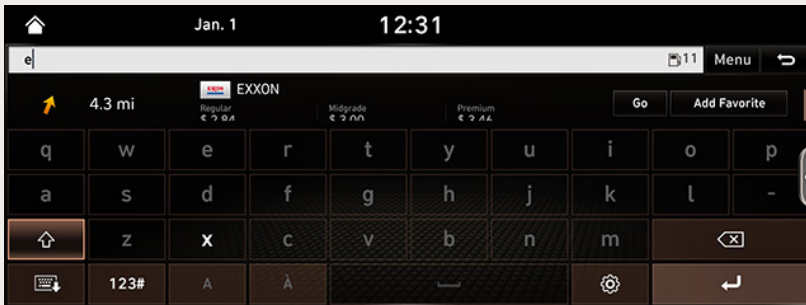

3. Select the desired item.



DELETING FAVORITES

1. Press [Favorites] > [Menu] > [Delete] in Fuel Prices list.

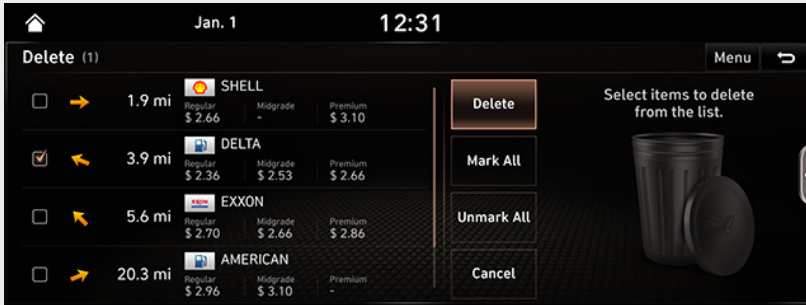

2. Select the item you want to delete and press [Delete] > [Yes].
 - [Mark all]: Marks all items.
 - [Unmark all]: Unmarks all items.
 - [Cancel]: Exits delete screen.

MEDIA





PLAYING AUDIO CD/MP3 CD

This item is for customers who have selected the disc deck option.
Insert a disc into the disc slot and playback will start automatically.

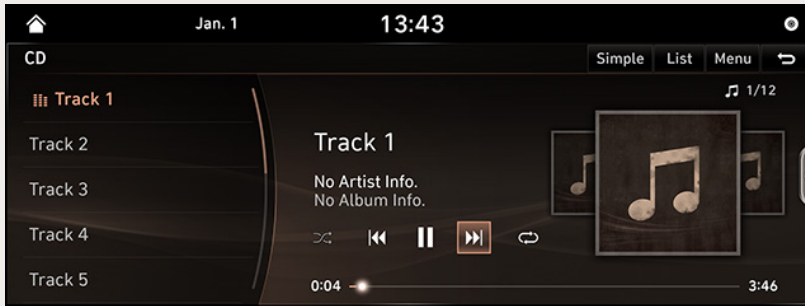

<Audio CD>

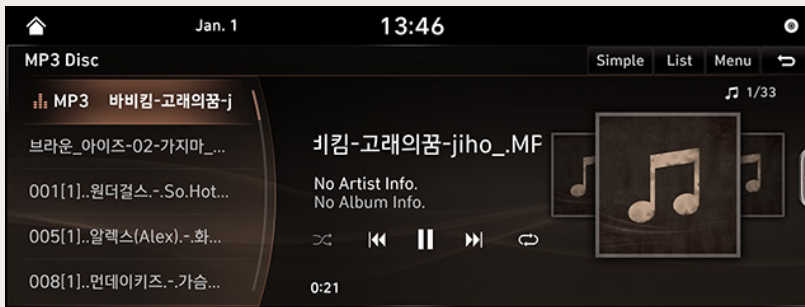

<MP3 CD>

! NOTE

To play the Audio CD or MP3 CD while a different source is playing, press [HOME] or [HOME] > [Media] > [CD] or [MP3 Disc].

PAUSE

You can pause the playing track/file.

Press [||] on screen.

Press [▶] on screen to play it again.



SKIP

You can play the previous or next track/file.

Position	Description
Screen	<ul style="list-style-type: none"> • Press [⏮/⏭]. • Pressing [⏮] after 3 seconds of playback time plays the current track/file from the beginning in case of the split screen.
Rear Seat control key	<ul style="list-style-type: none"> • Press [< SEEK >]. • Pressing [< SEEK >] after 3 seconds of playback time plays the current track/file from the beginning in case of the split screen.

SEARCH

You can rewind/fast forward to a specific point of a track/file.

Position	Description
Screen	Press and hold [⏮/⏭] and then release at the point you want.
Rear Seat control key	Press and hold [< SEEK >] and then release at the point you want.

SEEK

You can play the track/file directly by searching for the desired track/file.

Turn [TUNE/FILE] to search for a desired track/file. If the desired track/file is displayed, press the [TUNE/FILE] to play the track/file.



LIST

You can play the desired track/file by searching the track/file list included in the disc.

1. Press [List]. Or press [Menu] > [List].

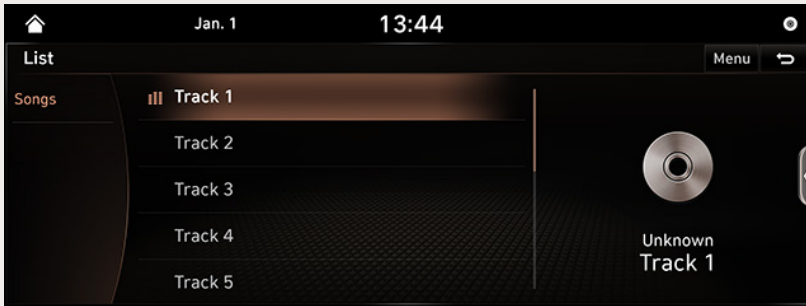

<For example: Audio CD>

2. Press the desired track/file.

SHUFFLE

All track/file can be played randomly.

Press [Menu] > [Shuffle] from the playing screen.

! NOTE

You can set or cancel the Shuffle function by pressing [] on the playing screen.



REPEAT

The current playing track/file is played repeatedly.

1. Press [Menu] > [Repeat].

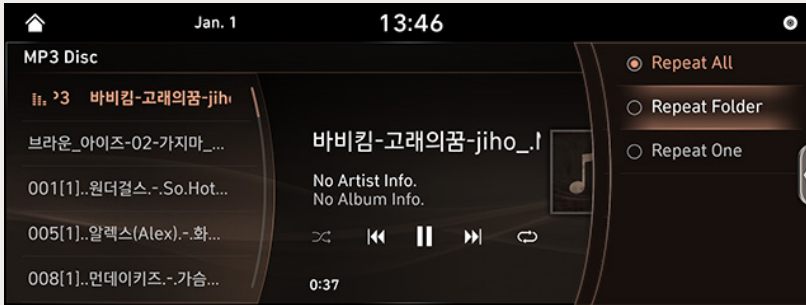

<For example: MP3 CD>

2. Press the desired item.
 - [Repeat all]: Repeats all track/file.
 - [Repeat folder]: Repeats all files within the current folder. (MP3 CD only)
 - [Repeat track]: Repeats the current track/file.

! NOTE

You can set or cancel the Repeat function by pressing on the playing screen.

SONG INFORMATION

This feature shows the artist, title, album and folder information of the song.

Press [Menu] > [Song Information].

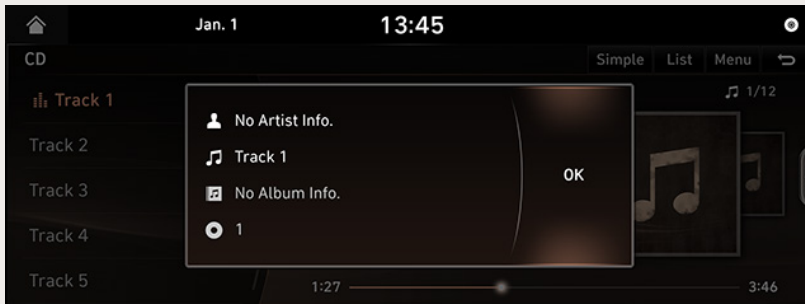

<For example: Audio CD>



PLAYING DVD

This item is for customers who have selected the disc deck option.

Insert a disc into the disc slot, with the label facing up.

Playback will start automatically. In some cases, the disc menu might appear.

! NOTE

- To play DVD while a different source is playing, press [HOME] or > [Media] > [DVD].
- If a menu screen is displayed, select the desired option by using the controller.
- Video is not available while driving. (Because of traffic regulations, video is only available while the vehicle is stopped or the transmission lever is put to P position.)

PAUSE

You can pause the playing chapter.

Press [⏏] on screen.

Press [▶] on screen to play it again.

SKIP

You can play the previous or next chapter.

Position	Description
Screen	<ul style="list-style-type: none"> • Press [⏮/⏭]. • Pressing [⏮] after 3 seconds of playback time plays the current chapter from the beginning.
Rear Seat control key	<ul style="list-style-type: none"> • Press [< SEEK >]. • Pressing [< SEEK] after 3 seconds of playback time plays the current chapter from the beginning.



SEARCH

You can rewind/fast forward to a specific point of a chapter.

Position	Description
Screen	Press and hold [⏮/⏭] and then release at the point you want.
Rear Seat control key	Press and hold [< SEEK >] and then release at the point you want.

SEEK

You can play the chapter directly by searching for the desired chapter.

Turn [TUNE/FILE] to search for a desired chapter. If the desired chapter is displayed, press the [TUNE/FILE] to play the chapter.

SWITCHING TO MENU SCREEN OR FULL SCREEN

- Press the screen.
- Press [⏏] on the playing screen.
- Press [Menu] > [Full Screen].
- Wait 5 seconds to display the Full screen on the menu screen.



TITLE MENU/DISC MENU

If the current title has a menu, the menu will appear on the screen.

1. Press [Menu].

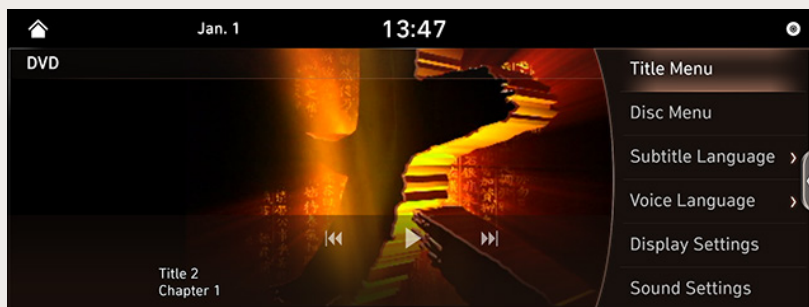

2. Press [Title menu] or [Disc menu].
3. Select the desired item.
4. Press [OK].



SUBTITLE LANGUAGE

Choose from all available subtitle languages.

1. Press [Menu] > [Subtitle language].

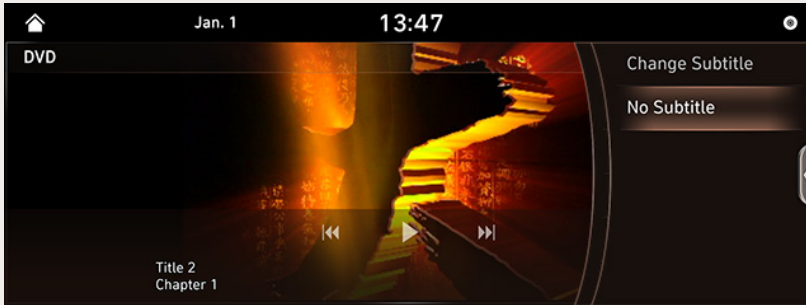

2. Select the desired subtitle language.

! NOTE

The caption language may vary depending on the title of DVD.

VOICE LANGUAGE

Choose from all available audio languages.

1. Press [Menu] > [Voice language].

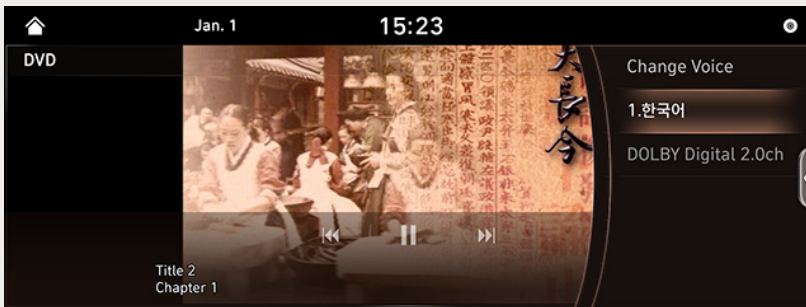

2. Select the desired audio language.

! NOTE

The audio language may vary depending on the title of DVD.

ANGLE

Choose from all available camera angles.

1. Press [Menu] > [Angle].

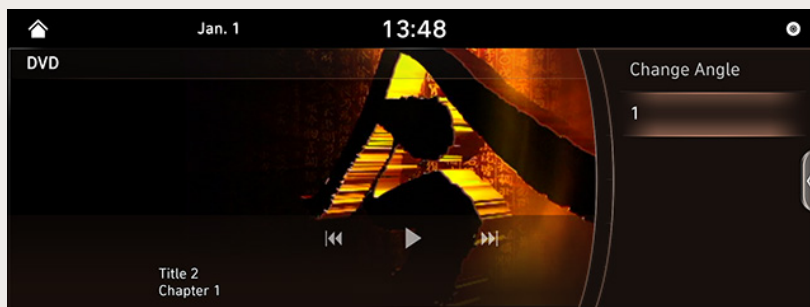

2. Select the desired angle.

NOTE

The angle may vary depending on the title of DVD.



DVD SETTINGS

Set the default language.

1. Press [Menu] > [DVD Settings].

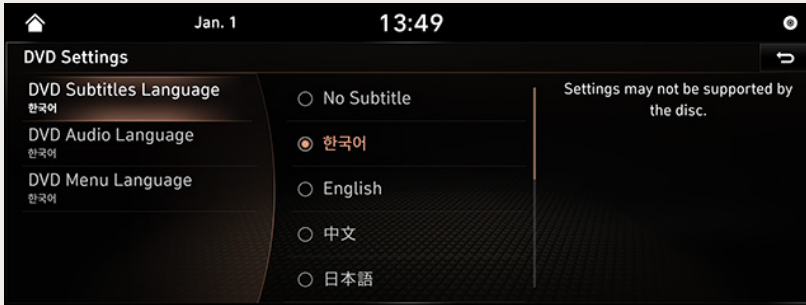

2. Press the desired item.

- [DVD subtitle language]: Select the desired subtitle language.
- [DVD audio language]: Select the desired audio language.
- [DVD menu language]: Select the desired menu language.

! NOTE

If there is no desired language, press [Other languages]. Input the DVD language code, then press [OK]. Refer to “DVD language code” part.



DVD LANGUAGE CODE

Code	Country	Code	Country
0101	Afar	1222	Latvian
0102	Abkhazian	1307	Malagasy
0106	Afrikaans	1309	Maori
0113	Amharic	1311	Macedonian
0118	Arabic	1312	Malayalam
0119	Assamese	1314	Mongolian
0125	Aymara	1315	Moldavian
0126	Azerbaijani	1318	Marathi
0201	Bashkir	1319	Malay
0205	Belarusian	1320	Maltese
0207	Bulgarian	1325	Burmese
0208	Bihari	1401	Nauru
0209	Bislama	1405	Nepali
0214	Bengali	1412	Dutch
0215	Tibetan	1415	Norwegian
0218	Breton	1503	Occitan
0301	Catalan	1513	Oromo
0315	Corsican	1518	Oriya
0319	Czech	1601	Punjabi
0325	Welsh	1612	Polish
0401	Danish	1619	Pushto
0405	Germany	1620	Portuguese
0426	Bhutani	1721	Quechua
0512	Greek	1813	Romance
0514	English	1814	Kirundi
0515	Esperanto	1815	Romanian



0519	Spanish	1821	Russian
0520	Estonian	1823	Kinyarwanda
0521	Basque	1901	Sanskrit
0601	Persian	1904	Sindhi
0609	Finnish	1907	Sangho
0610	Fijian	1908	Croatian
0615	Faroese	1909	Sinhalese
0618	French	1911	Slovak
0625	Frisian	1912	Slovenian
0701	Irish	1913	Samoan
0704	Scots	1914	Shona
0712	Gallegan	1915	Somal
0714	Guarani	1917	Albanian
0721	Gujarati	1918	Serbian
0801	Hausa	1919	Swati
0809	Hindi	1920	Sesotho
0818	Croatian	1921	Sundanese
0821	Hungarian	1922	Swedish
0825	Armenian	1923	Swahili
0901	Interlingua	2001	Tamil
0905	Interlingue	2005	Telugu
0911	Inupiak	2007	Tajik
0914	Indonesian	2008	Thai
0919	Icelandic	2009	Tigrinya
0920	Italian	2011	Turkmen
0923	Hebrew	2012	Tagalog
1001	Japanese	2014	Tswana
1009	Yiddish	2015	Tongo



1022	Javanese	2018	Turkish
1101	Georgian	2019	Tsonga
1111	Kazakh	2020	Tatar
1112	Greenlandic	2023	Twi
1113	Cambodian	2111	Ukrainian
1114	Kannada	2118	Urdu
1115	Korean	2126	Uzbek
1119	Kashmiri	2209	Vietnamese
1121	Kurdish	2215	Volapuk
1125	Kirghiz	2315	Wolof
1201	Latin	2408	Xhosa
1214	Lingala	2515	Yoruba
1215	Laotian	2608	Chinese
1220	Lithuanian	2621	Zulu



PLAYING USB

PLAYING USB MUSIC

You can play music files saved in a USB memory device.

Connect an USB device to the USB port. Playback will start automatically.

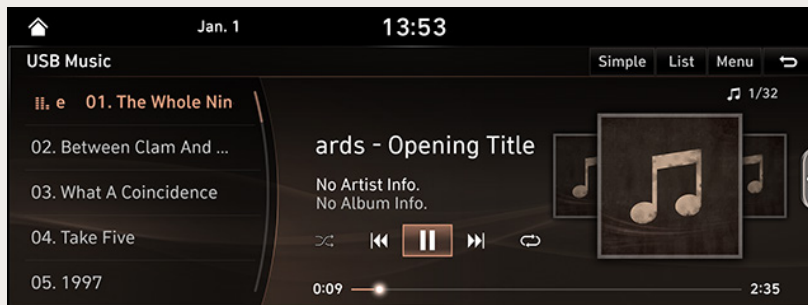

! NOTE

To play USB music while a different source is playing, press [HOME] or > [Media] > [USB Music].

PAUSE

You can pause the playing file.

Press [||] on screen.

Press [▶] on screen to play it again.

SKIP

You can play the previous or next file.

Position	Description
Screen	<ul style="list-style-type: none"> Press [◀◀/▶▶]. Pressing [◀◀] after 3 seconds of playback time plays the current file from the beginning in case of the split screen.
Rear Seat control key	<ul style="list-style-type: none"> Press [< SEEK >]. Pressing [< SEEK >] after 3 seconds of playback time plays the current file from the beginning in case of the split screen.



SEARCH

You can rewind/fast forward to a specific point of a file.

Position	Description
Screen	Press and hold [◀◀/▶▶] and then release at the point you want.
Rear Seat control key	Press and hold [< SEEK >] and then release at the point you want.

SEEK

You can play the file directly by searching for the desired file.

Turn [TUNE/FILE] to search for a desired file. If the desired file is displayed, press the [TUNE/FILE] to play the file.

LIST

You can play the desired file by searching the file list included in USB.

1. Press [List]. Or press [Menu] > [List].

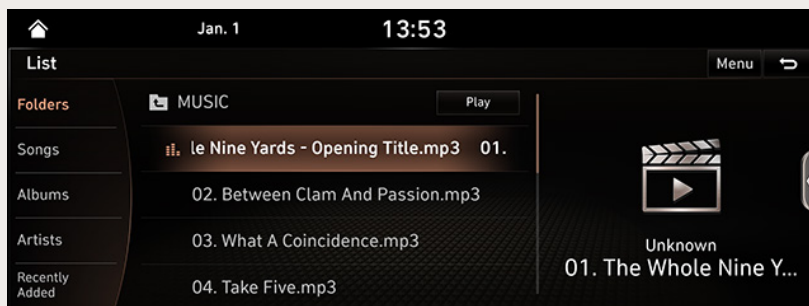

2. Press the desired file after searching for a category.
The category can be sorted by [Folders], [Songs], [Albums], [Artists] or [Recently Added].

NOTE

If you press [Play] on the list screen, plays from the first file within the selected folder.



SHUFFLE

All files can be played randomly.

Press [Menu] > [Shuffle] from the playing screen.

NOTE

You can set or cancel the Shuffle function by pressing on the playing screen.

REPEAT

The current playing file is played repeatedly.

1. Press [Menu] > [Repeat].

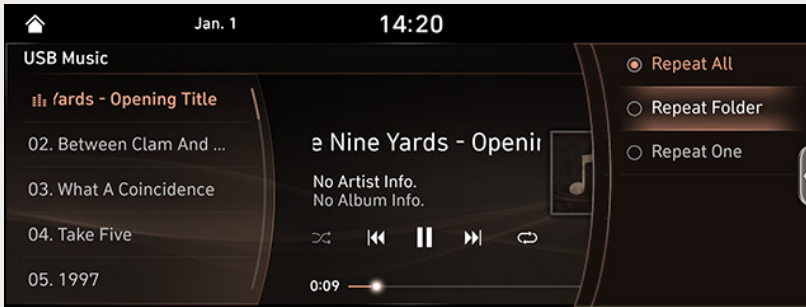

2. Press the desired item.

- [Repeat All]: Repeats all files.
- [Repeat Folder]: Repeats all files within the current folder.
- [Repeat One]: Repeats the current file.

NOTE

You can set or cancel the Repeat function by pressing / / / on the playing screen.

: Repeat All

: Repeat Album/Repeat Artist

(It is displayed when all files repeat during playback from the [Albums] or [Artists] category.)

: Repeat Folder

: Repeat One



SONG INFORMATION

This feature shows the artist, title, album and folder information of the song.

1. Press [Menu] > [Song information].

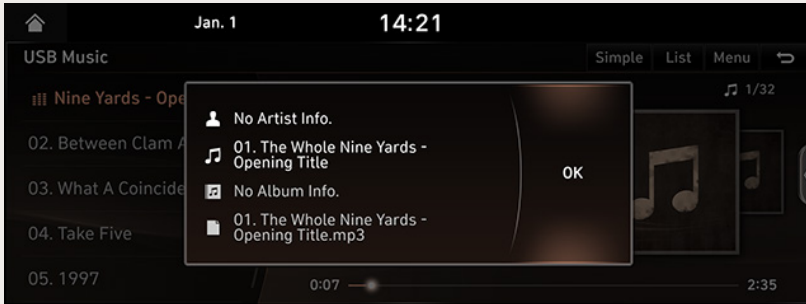

2. Press [OK].

HIDE CURRENT FILE

You can hide the current playing file.

1. Press [Menu] > [Hide Current File] from the playing screen.



2. Press [Yes].



SONGS OF THIS ARTIST

Moves the artist list of the current song.

Press [Menu] > [Songs for This Artist].

NOTE

You can go to the list by pressing artist on the playing screen.

SONGS OF THIS ALBUM

Moves the album list of the current song.

Press [Menu] > [Songs for This Album].

NOTE

You can go to the list by pressing album art on the playing screen.



PLAYING USB VIDEO

You can play video files saved in a USB memory device.

Connect a USB device to the USB port and playback starts automatically.

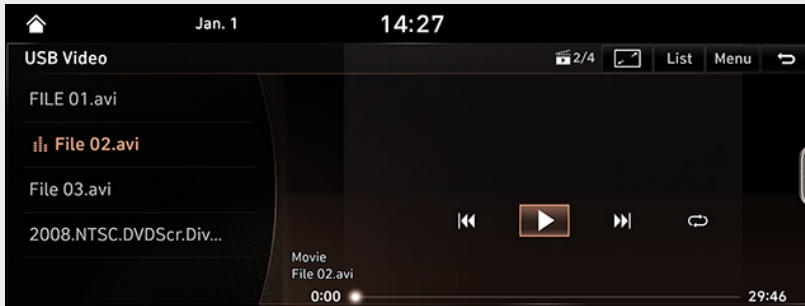

! NOTE

- To play USB Video while a different source is playing, press [HOME] or > [Media] > [USB Video].
- Video is not available while driving. (Because of traffic regulations, video is only available while the vehicle is stopped or the transmission lever is put to P position.)

PAUSE

You can pause the playing file.

Press [||] on screen.

Press [▶] on screen to play it again.

SKIP

You can play the previous or next file.

Position	Description
Screen	<ul style="list-style-type: none"> • Press [◀◀/▶▶] • Pressing [◀◀] after 3 seconds of playback time plays the current file from the beginning in case of the split screen.
Rear Seat control key	<ul style="list-style-type: none"> • Press [< SEEK >]. • Pressing [< SEEK] after 3 seconds of playback time plays the current file from the beginning in case of the split screen.



SEARCH

You can rewind/fast forward to a specific point of a file.

Position	Description
Screen	Press and hold [◀◀/▶▶] and then release at the point you want.
Rear Seat control key	Press and hold [< SEEK >] and then release at the point you want.

SEEK

You can play the file directly by searching for the desired file.

Turn [TUNE/FILE] to search for a desired file. If the desired file is displayed, press the [TUNE/FILE] to play the file.

SWITCHING TO MENU SCREEN OR FULL SCREEN

- Press the screen.
- Press [◻] on the playing screen.
- Press [Menu] > [Full Screen].
- Wait 5 seconds to display the Full screen on the Menu screen.

LIST

You can play the desired file by searching the file list included in USB.

1. Press [List]. Or press [Menu] > [List].

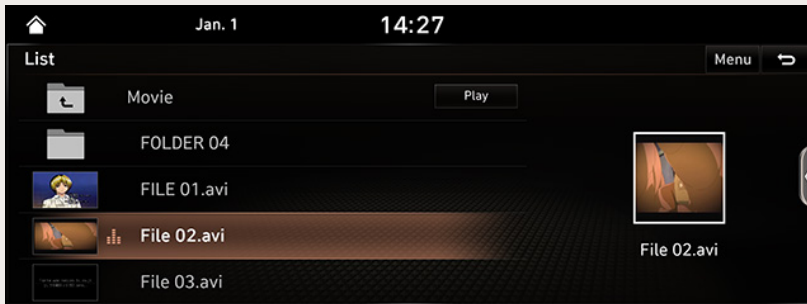

2. Press the desired file.

! NOTE

If you press [Play] on the list screen, plays from the first file within the selected folder.



REPEAT

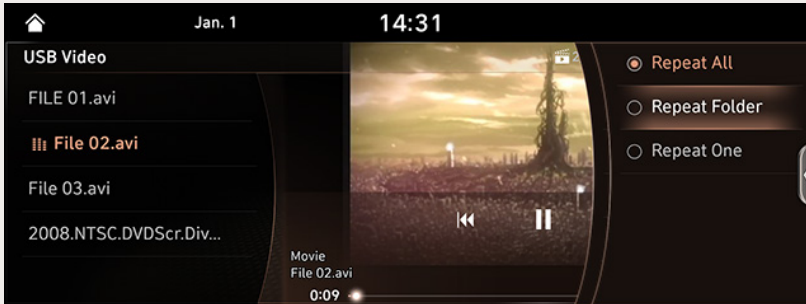

The current playing file is played repeatedly.

1. Press [Menu] > [Repeat].



2. Press the desired item.
 - [Repeat All]: Repeats all files.
 - [Repeat Folder]: Repeats all files within the current folder.
 - [Repeat One]: Repeats the current file.

NOTE

You can set or cancel the Repeat function by pressing [//] on the playing screen.



FILE INFORMATION

This feature shows the name, resolution and playback time information of the file.

1. Press [Menu] > [File information].

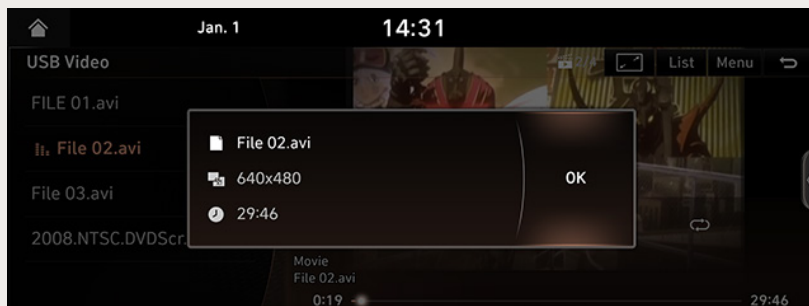

2. Press [OK].



SUBTITLE SETTINGS

1. Press [Menu] > [Subtitle Settings].

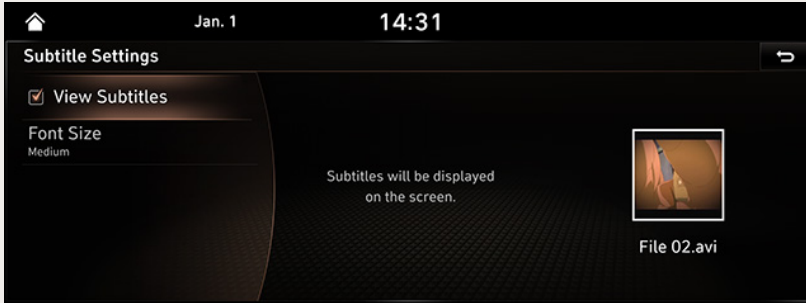

2. Set the desired option.
 - [View Subtitles]: Turns video subtitles on/off.
 - [Font Size]: Adjusts the font size of video subtitles.

VOICE SETTINGS

1. Press [Menu] > [Voice Settings].

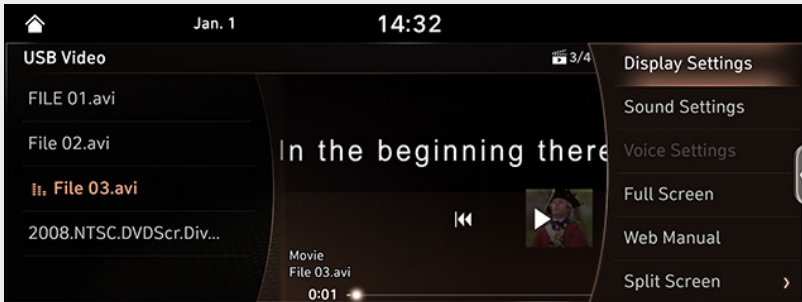

2. Set the desired voice.



PLAYING IPOD®

1. Use iPod exclusive cable to connect iPod to USB connector.
2. Press [HOME] or [HOME] > [Media] > [iPod]. It runs iPod mode.

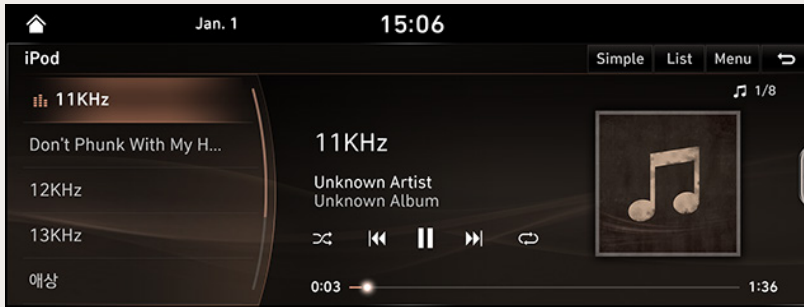

PAUSE

You can pause the playing file.

Press [||] on screen.

Press [▶] on screen to play it again.

SKIP

You can play the previous or next file.

Position	Description
Screen	<ul style="list-style-type: none"> • Press [◀◀/▶▶] • Pressing [◀◀] after 3 seconds of playback time plays the current file from the beginning.
Rear Seat control key	<ul style="list-style-type: none"> • Press [< SEEK >]. • Pressing [< SEEK] after 3 seconds of playback time plays the current file from the beginning.



SEARCH

You can rewind/fast forward to a specific point of a file.

Position	Description
Screen	Press and hold [⏮/⏭] and then release at the point you want.
Rear Seat control key	Press and hold [< SEEK >] and then release at the point you want.

SEEK

You can play the file directly by searching for the desired file.

Turn [TUNE/FILE] to search for a desired file. If the desired file is displayed, press the [TUNE/FILE] to play the file.

LIST

SEARCHING THE LIST

You can play the desired file by searching the file list included in iPod.

1. Press [List]. Or press [Menu] > [List].

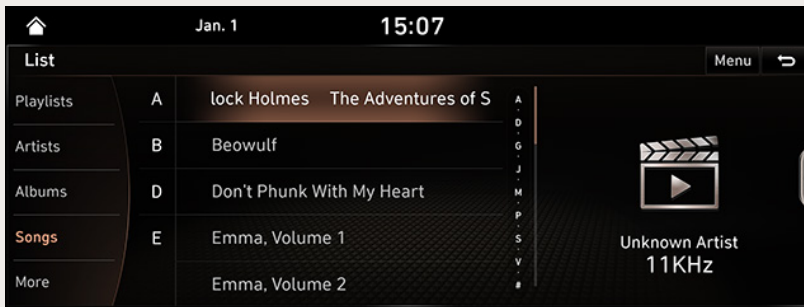

2. Press the desired file after searching for a category.
The category can be sorted by [Playlists], [Artists], [Albums], [Songs] or [More].



REORDERING CATEGORIES

1. Press [Menu] > [Reorder Categories] on the List screen.

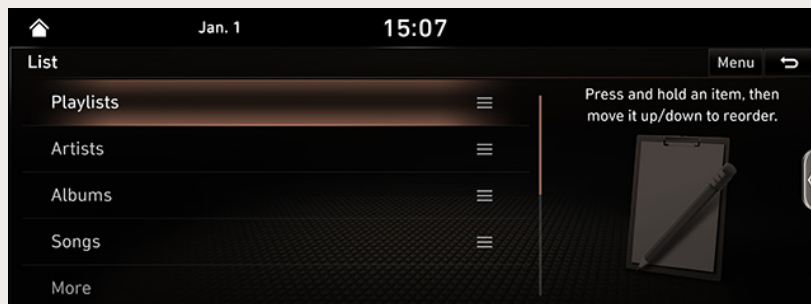

2. Press and hold an item, then move it up/down to reorder.

SHUFFLE

All files can be played randomly.

Press [Menu] > [Shuffle] from the playing screen.

! NOTE

You can set or cancel the Shuffle function by pressing [**⏮**] on the playing screen.





REPEAT

The current playing file is played repeatedly.

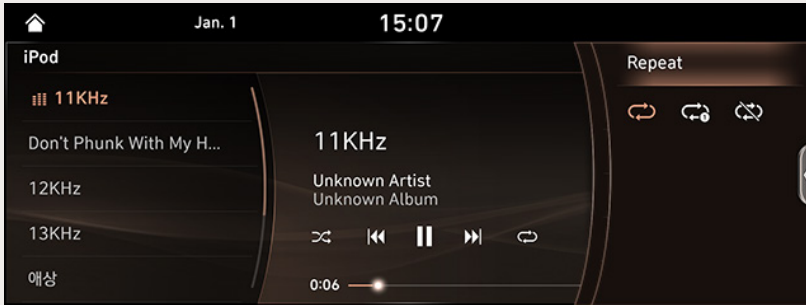
1. Press [Menu] > [Repeat].



2. Press [Repeat] repeatedly.
 - : Repeats all files.
 - : Repeats the current file.
 - : Cancels the repeat function.

! NOTE

You can change the repeat function by pressing [ /  / 

SONG INFORMATION

This feature shows the artist, title and album information of the song.

1. Press [Menu] > [Song Information].

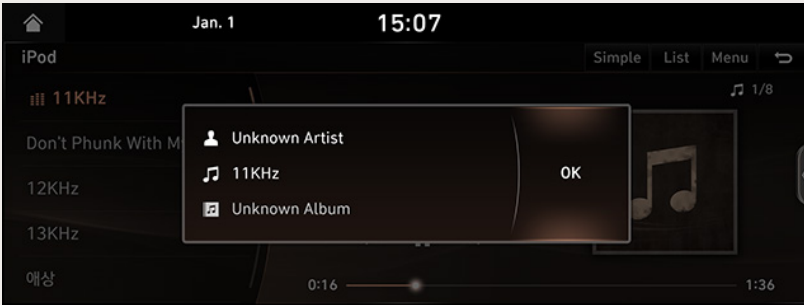

2. Press [OK].



PLAYING BLUETOOTH® AUDIO

BEFORE PLAYING THE BLUETOOTH® AUDIO

- Music saved in the mobile phone can be played in the car through Bluetooth audio streaming.
- Bluetooth audio can be played only when a Bluetooth phone has been connected. To play Bluetooth audio, connect the Bluetooth phone to the car system. For more information on connecting Bluetooth, please refer to the "Pairing and connecting the unit and a Bluetooth phone" part.
- The audio streaming function may not be supported in some mobile phones. Only one function can be used at a time between the Bluetooth handsfree or Bluetooth audio function. For example, if you convert to the Bluetooth handsfree while playing Bluetooth audio, the music will be paused.

STARTING THE BLUETOOTH® AUDIO

1. Press [HOME] or > [Media] > [Bluetooth Audio].
2. The Bluetooth audio screen is displayed.

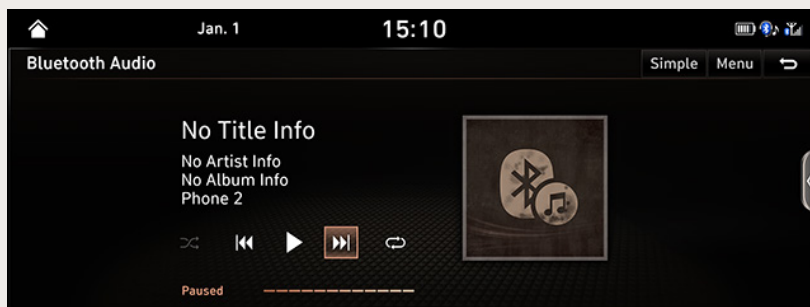

PAUSE

You can pause the playing file.

Press on screen.

Press on screen to play it again.

NOTE

This feature may not be supported on some Bluetooth devices.



SKIP

You can play the previous or next file.

Position	Description
Screen	<ul style="list-style-type: none"> • Press [/▶▶]. • Pressing [] after 3 seconds of playback time plays the current file from the beginning.

! NOTE

This feature may not be supported on some Bluetooth devices.

SHUFFLE

All files can be played randomly.

Press [Menu] > [Shuffle] from the playing screen.

! NOTE

- You can set or cancel the Shuffle function by pressing [] on the playing screen.
- This feature may not be supported on some Bluetooth devices.

REPEAT

The current playing file is played repeatedly.

1. Press [Menu] > [Repeat].
2. Press the desired item.
 - [Repeat All]: Repeats all files.
 - [Repeat One]: Repeats the current file.
 - [Repeat Off]: Cancels the repeat function.

! NOTE

- You can change the Repeat function by pressing [/▶▶/▶▶] on the playing screen.
- This feature may not be supported on some Bluetooth devices.



SONG INFORMATION

This feature shows the artist, title and album information of the song.

1. Press [Menu] > [Song Information].

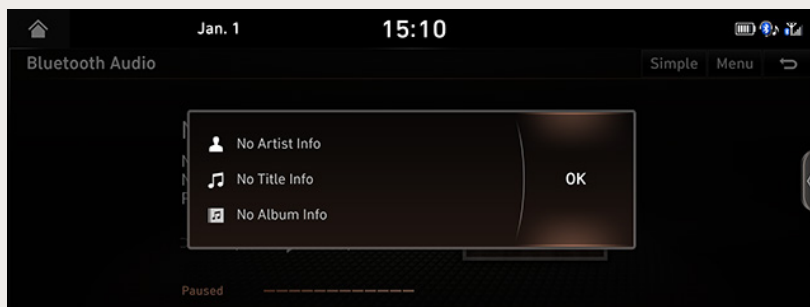

2. Press [OK].

CONNECTION SETTINGS

1. Press [Menu] > [Connection Settings].
2. For more details, refer to the "Bluetooth" part.

RADIO





LISTENING TO FM/AM RADIO

1. Press [RADIO] on the head unit. Or press [HOME] or > [Radio].
2. Press [Band] > [FM] or [AM] on the screen.
The FM/AM screen of the most recent listened frequency is displayed.

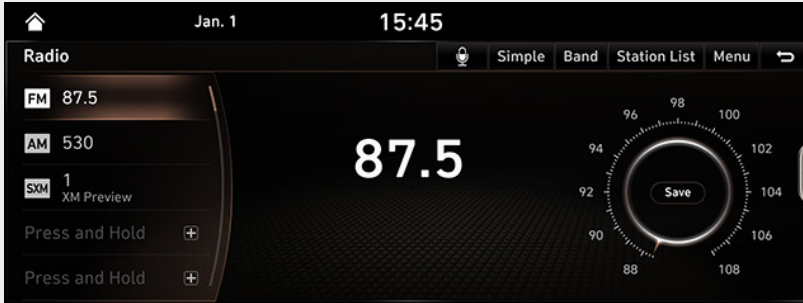

AUTO TUNING

Press [\lt SEEK \gt] on the Rear Seat control key. When a frequency is received, searching stops.

MANUAL TUNING

Turn [TUNE/FILE] on the head unit in clockwise or counter-clockwise direction.

PRESET TUNING

Select the preset you want to listen to.



SAVING FM/AM AS PRESETS

A maximum of 40 frequencies can be saved manually as presets.

1. Select the band (FM, AM) you want to store a frequency into.
2. Select the desired frequency.
3. Press [Menu] > [Save as Preset].



4. Press [Save].
The frequency is saved.

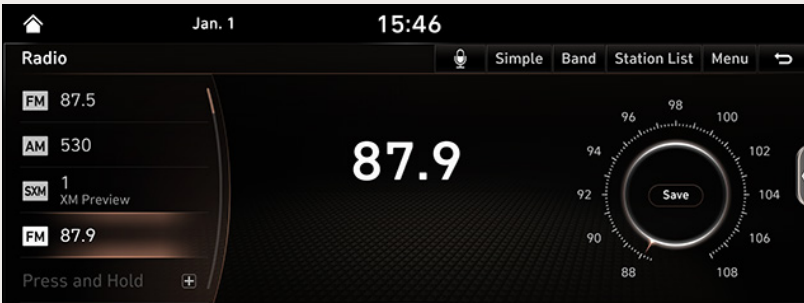

! NOTE

- If you want to save the frequency from [Preset] menu, press and hold **[+]**.
- When the frequency is saved on a preset of which another frequency has already been saved, the previously saved frequency is erased.



DELETING FM/AM PRESETS

1. Press [Menu] > [Delete Presets] on the FM/AM screen.

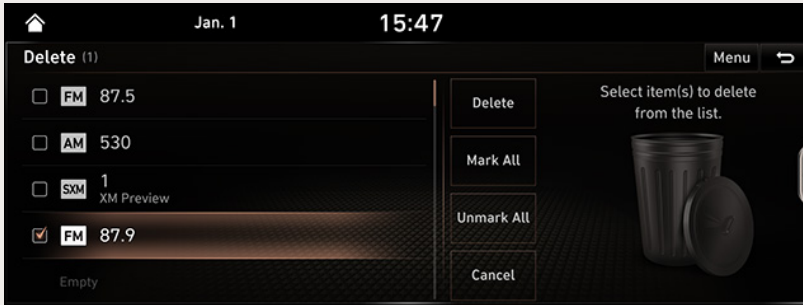

2. Select the desired item, then press [Delete] > [Yes].
 - [Mark all]: Marks all items.
 - [Unmark all]: Unmarks all items.
 - [Cancel]: Exits delete screen.

SCANNING FM/AM BROADCAST STATION

This function scans all frequencies and plays only frequencies with superior reception for 5 seconds each.

1. Select the band (FM, AM) you want.
2. Press [Menu] > [Scan FM] or [Scan AM].

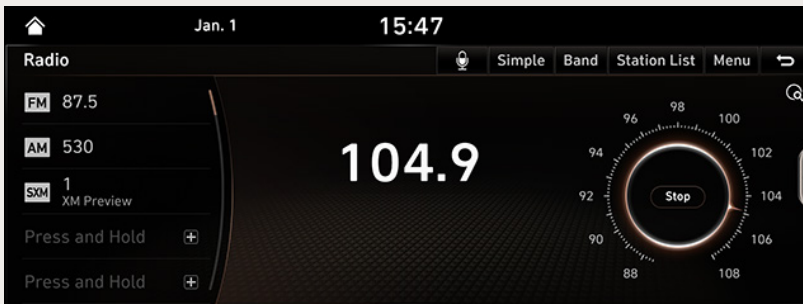

! NOTE

When the scan is operating, pressing the controller will stop the function and remain on the stopped frequency.



STATION LIST

You can see broadcast station list with superior reception.

1. Select the band (FM, AM) you want.
2. Press [Station List] on the screen. Or press [Menu] > [Station List].

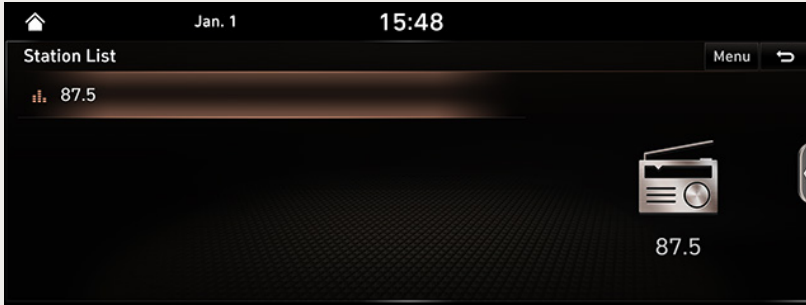

3. Press the desired broadcast station.
 - Press [Menu] > [Refresh] to refresh the Station List.

REORDERING FM/AM PRESET

This function reorders the frequency saved to presets.

1. Select the band (FM, AM) you want.
2. Press [Menu] > [Reorder Presets].

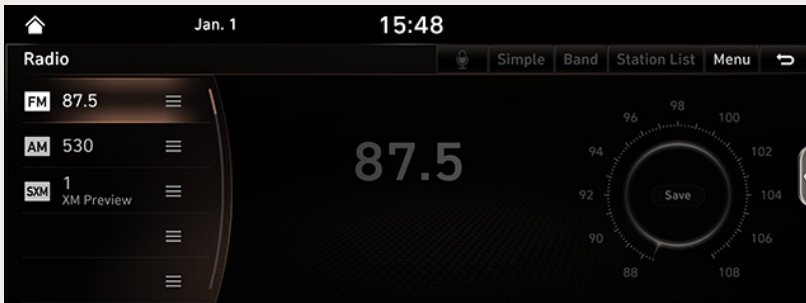

3. Press and hold a preset, then move it up/down to reorder.



RADIO TEXT ON/OFF

If current broadcast includes Radio Text information, the text information is displayed on the screen.

1. Select the band (FM, AM) you want.
2. Press [Menu] > [Show Radio Text].

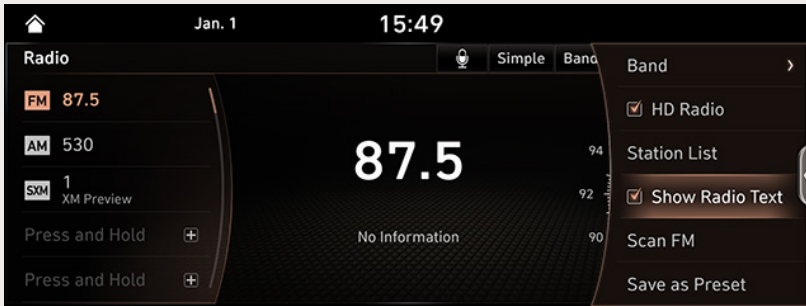

3. Pressing the [Show Radio Text] again will cancel the function.



LISTENING TO HD RADIO™

You can turn HD radio on from the menu and listen to HD Radio Broadcasts. The HD Radio screen is displayed only when a HD Radio broadcast is being received.

HD RADIO™ SCREEN

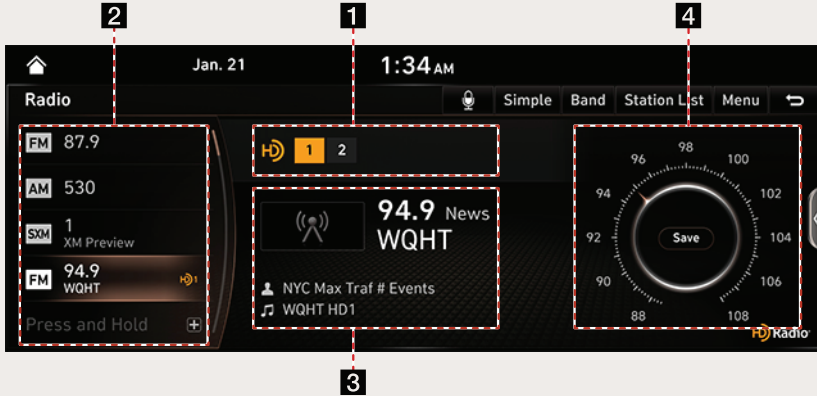

1 HD Radio Reception & Channel buttons

Displays main HD Radio channels and used to directly select the currently available local channels.

2 HD Channel Number

- HD Channel number saved in preset.
- Preset tuning: From the 40 presets, select the HD Channel you want to listen to.

3 Broadcast Information

Displays detailed information about the current broadcast. (Artist name, Song title, HD radio channel, Frequency, PTY, etc...)

4 Frequency controller

When controller is focused, it moves to center of screen. Turn the controller to search for frequency and move the red line.

! NOTE

HD Radio reception is included with the vehicle is in Radio mode. Methods used to reorder between channels, save preset frequency, or other methods of searching frequencies used for standard radios are identical for HD Radios. The HD Radio icon will be displayed when the vehicle is within regions where HD Radio signals can be received.



HD RADIO™ ON/OFF

1. Select the band (FM, AM) you want. If an HD Radio broadcast is received, the radio mode will switch from analog broadcast to HD Radio broadcast.

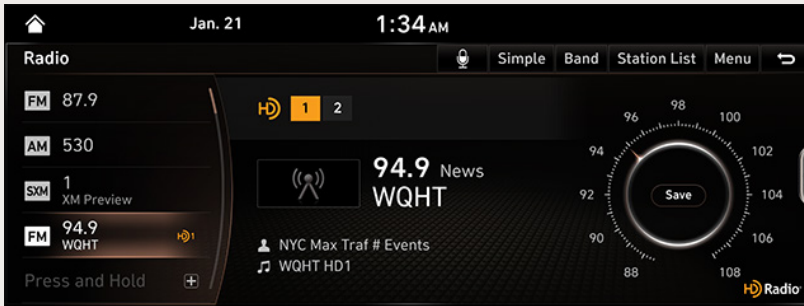

2. Press [Menu] > [HD Radio] on the screen. The HD radio will be off and switch to analog broadcast.

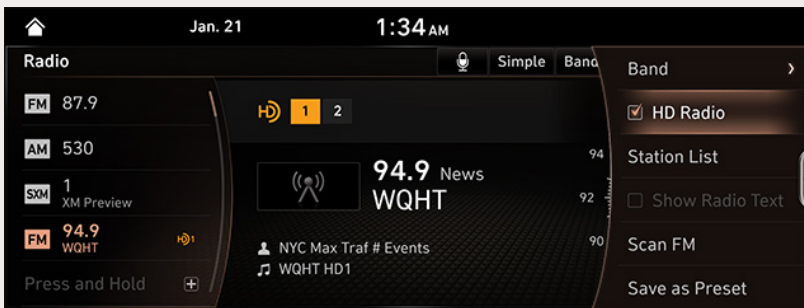

NOTE

- The default setting of [HD Radio] is set to on.
- HD radio Technology is a digital radio technology used by FM and AM radio broadcast stations to transmit audio and data via a digital signal in conjunction with their analog signals.
- While listening to the radio, the HD Radio icon will become displayed if receiving an HD radio broadcast.



LISTENING TO SIRIUSXM™ RADIO

1. Press [RADIO] on the head unit. Or press [HOME] or > [Radio].
2. Press [Band] > [SiriusXM] on the screen. The SiriusXM radio screen of the most recent listened channel will be displayed.



3. Select the desired broadcast channel.

SIRIUSXM™ SCREEN

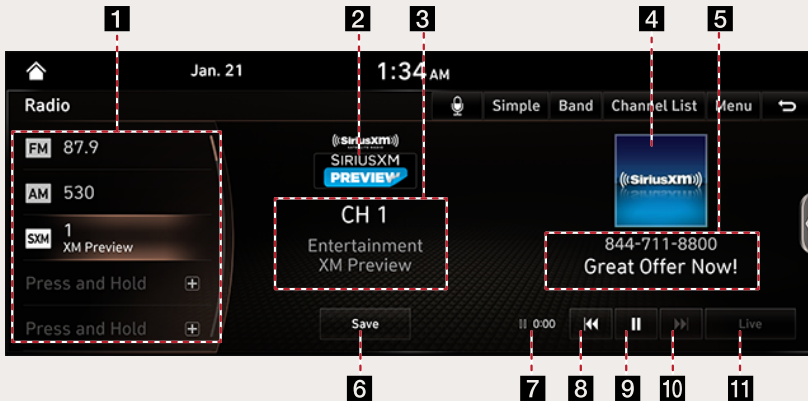

1 Preset list

Displays the channels saved in the Preset list.

Smart Favorites

SXM supports 10 smart favorites. It is buffered 1 hour for the currently tuned channel (Instant Replay) and at least 1/2 hour for each of the 10 smart favorites.

**2 Channel Logo**

Displays the logo of the channel currently playing.

3 Channel Info

Displays the current channel number and name.

Category Info

Displays the category currently playing.

4 Album Art

Displays the current album art image.

5 Contents Info

Displays the artist, title and other information about the song currently playing.

6 Save

Saves the current channel as preset.

7 Time difference

Displays the time difference between the song playing and the Live broadcast.

8 <<

Repeats the previously broadcasted program.

- When it is pressed shortly: Moves to the previous item.
- When it is pressed and held: Searches backwards until the button is released.

9 ▶ / || (Play/Pause)

Plays/Pauses the currently broadcasting program.

10 >>

- When it is pressed shortly: Moves to the next item.
- When it is pressed and held: Searches forward until the button is released.

11 Live

Changes to the Live Broadcast mode.



SELECTING SIRIUSXM™ BROADCAST CHANNEL

SELECTING A CHANNEL THROUGH MANUAL SEARCH

Turn [TUNE/FILE] on the head unit clockwise or counter-clockwise to display the previous or next channel information.

SELECTING WITH CHANNEL UP/DOWN

Press [< SEEK >] on the Rear Seat control key.
- The previous or next channel will be selected.

SELECTING A CHANNEL THROUGH PRESET

Press the preset button of the desired channel.

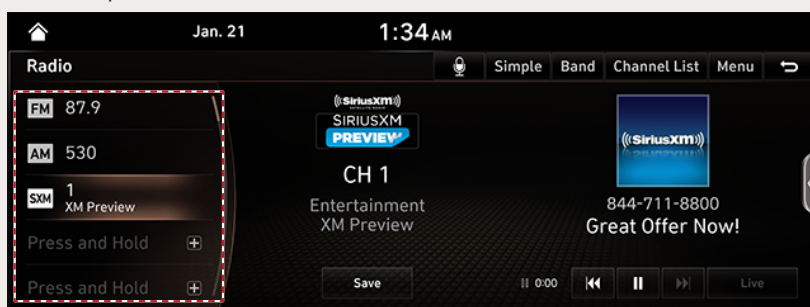

SELECTING CHANNEL THROUGH CHANNEL/CATEGORY LIST

1. Press [Channel list] on the screen. Or press [Menu] > [Channel list].

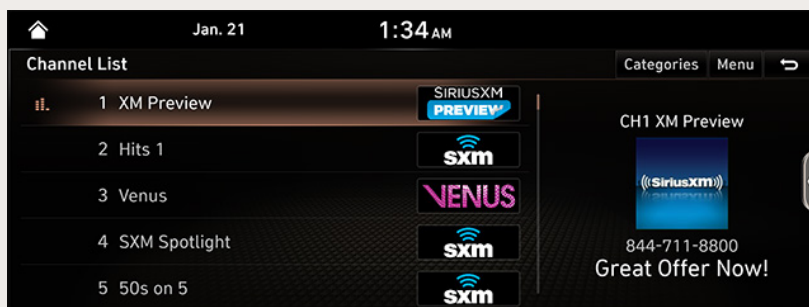

2. Select the desired category and channel.

- Press [Categories] or [Menu] > [Category List] to move to the [Category List] menu.
- Press [Menu] > [Featured Favorites] to move to the [Featured Favorites] menu.
- If you want to skip a channel, press [Menu] > [Skip]. After press the channel to skip, press [↩] to confirm your selection.

**! NOTE**

The channel list may be different according to the region.

SCANNING SIRIUSXM™ BROADCAST CHANNEL

1. Press [Menu] on the SiriusXM radio screen.



2. Press [Scan SXM Channels].
Scans all receivable channels for 5 seconds each.

! NOTE

When the scan is operating, pressing the controller will cancel the function and return to the previous channel.



ENTER CHANNEL

This feature is used to search for channels by entering channel numbers.

1. Press [Menu] > [Enter Channel] on the SiriusXM radio screen.

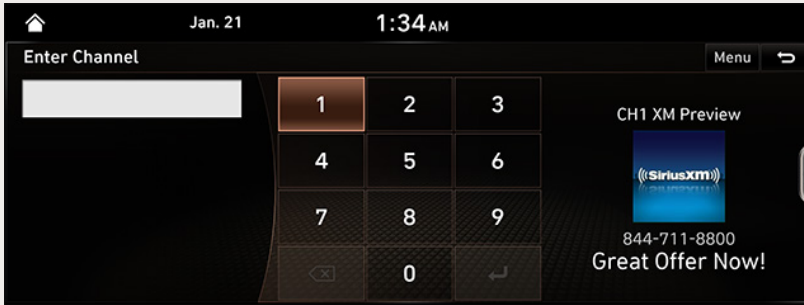

2. Enter the number of the channel you want to receive and press [↵].

SAVING SIRIUSXM™ PRESET

A total of 40 SiriusXM channels can be saved.

1. Select the desired channel.
2. Press [Save] or [Menu] > [Save as Preset].
3. Press the desired preset number.

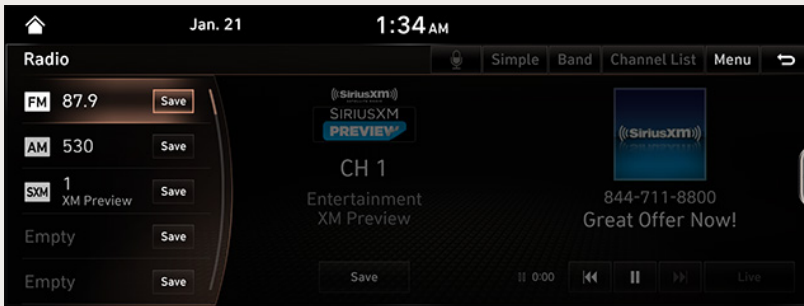

The channel is saved.

! NOTE

When the channel is preset on a number of which another channel has already been preset, the previously preset channel is erased.



PROGRAM GUIDE

You can check the program information and the schedules of broadcast channels.

1. Press [Menu] > [Program Guide] on the SiriusXM radio screen.

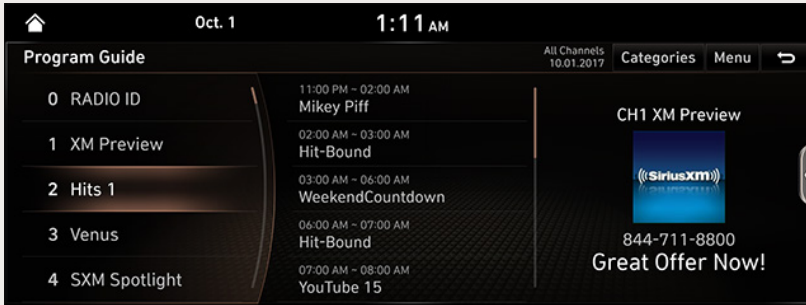

- Press [Categories] to search for category. Or Press [Menu] > [Category list].
2. Select the desired broadcast channel.

When you select the current broadcast channel:

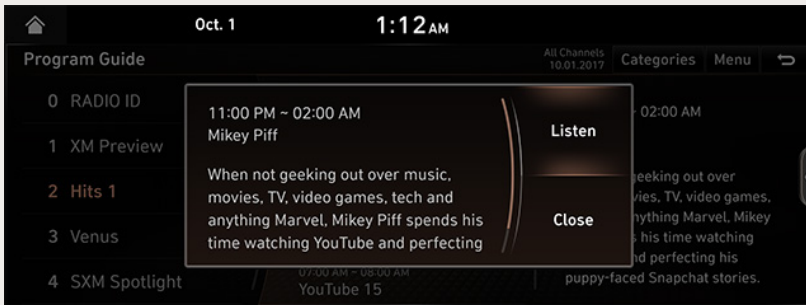

When you select the other broadcast except the current broadcast channel

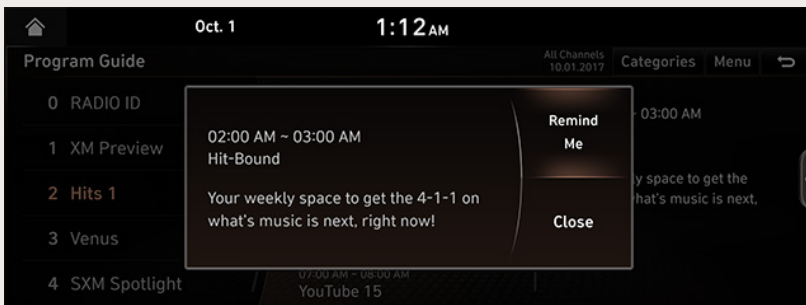



3. Select the desired item.
 - Press [Listen] to listen to the current broadcast.
 - Press [Remind Me] to reserve the broadcast.
 - Press [Close] to close the function.

! NOTE

Reminder time may be different from time set by user.

ADDING TO FAVORITES

You can add the artist or song in the [Favorites] menu.

1. Press [Menu] > [Add to Favorites] on the SiriusXM radio screen.

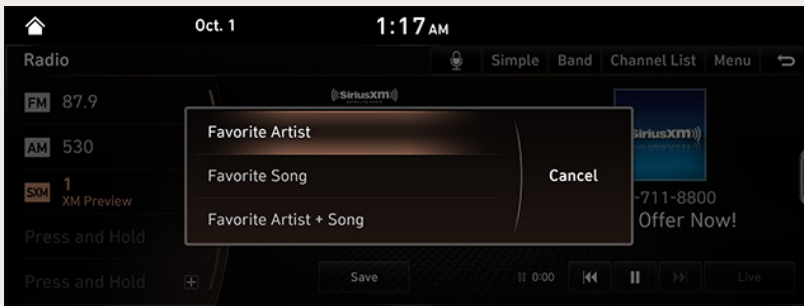

2. Select the artist or song to add to [Favorites] menu.

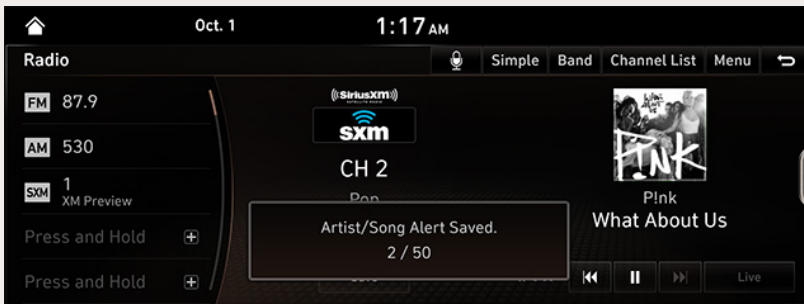

It displays the number of the saved favorites and the number of total favorites.

! NOTE

You can play the song or artist by selecting the desired item when the song or artist added in [Favorites] menu is playing on other channel.



REORDERING SIRIUSXM™ PRESET

The 40 SiriusXM channels can be reordered.

1. Press [Menu] > [Reorder Presets] on the SiriusXM radio screen.
2. Press the desired preset from the list.



3. Press and hold a preset, then move it up/down to reorder.

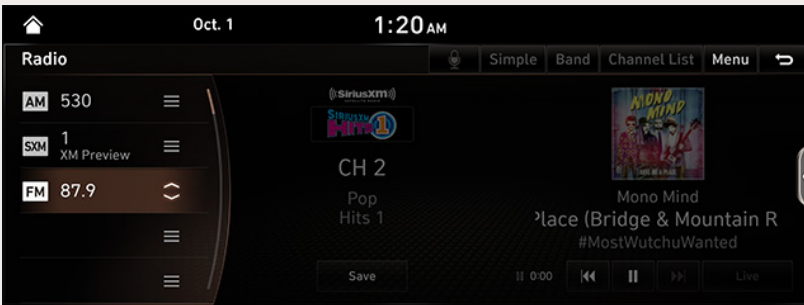



GAME ZONE

You can check the list of sports leagues and games for selected league. (League : NFL, MLB, NBA, NHL, CFB, CBK, WCBK)

1. Press [Menu] > [More Features] > [Game Zone] on the SiriusXM radio screen.



<Live broadcast mode>

2. Listen to live broadcast by selecting the desired league and game.

SETTING TEAM

You can listen to the game of the favorite team by marking the favorite team.

1. Press [Teams] on the live broadcast mode.
2. Select the desired league and mark the desired team.

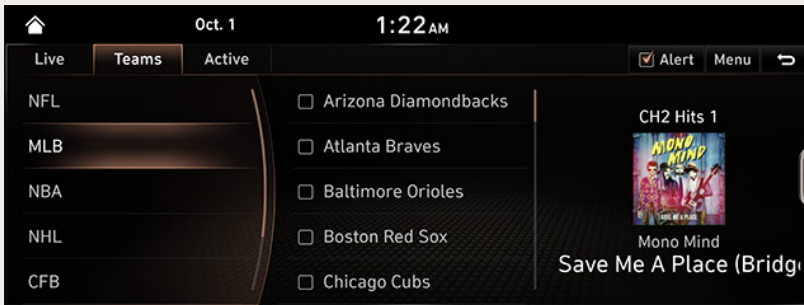

NOTE

When the marked team is playing on other channel, the pop-up is displayed on the screen. For more details, refer to "Alert On/Off".



VIEWING ACTIVE ALERT

You can listen to live broadcast by selecting the channel when the marked team is playing on other channel.

1. Press [Active] on the live broadcast mode.



2. Listen to live broadcast by selecting the desired item.



ALERT ON/OFF

This feature sets whether to display the pop-up on the screen when the marked team is playing on other channel.

1. Press [Alert] on the [Teams] screen.

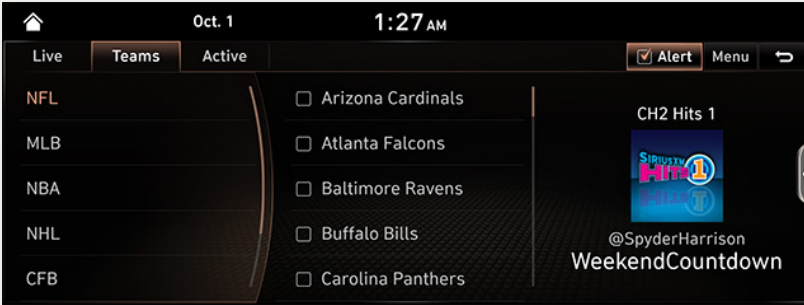

2. When the marked team is playing on other channel, the pop-up is displayed on the screen.

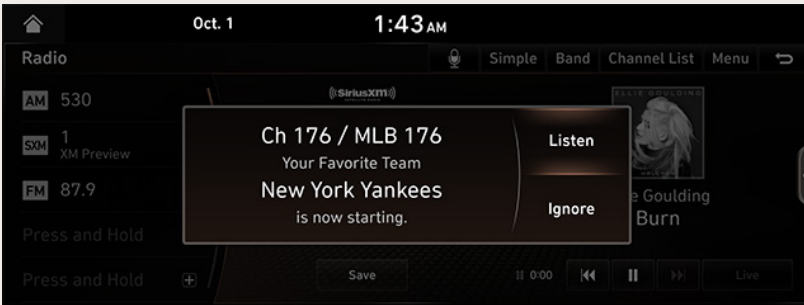

- [Listen]: Moves to the selected channel.
- [Ignore]: Moves to the previous screen.



FAVORITES

You can check the song or artist added in [Favorites] menu.

Add the song or artist in the [Favorites] menu.

Press [Menu] > [More Features] > [Favorites] on the SiriusXM radio screen. The Favorites menu is displayed on the screen.

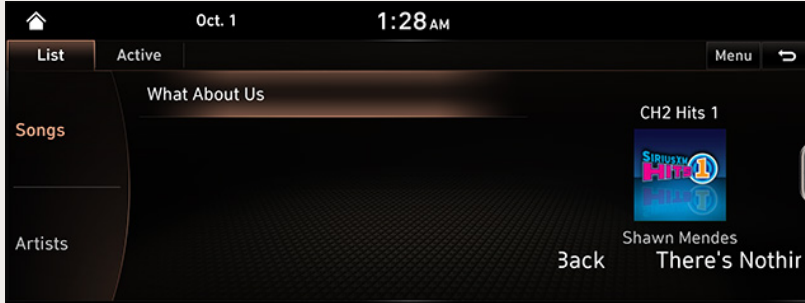

<Favorites list>

! NOTE

When the song or artist added in [Favorites] menu is playing on other channel, the pop-up is displayed on the screen.

VIEWING ACTIVE ALERT

You can listen to live broadcast by selecting the channel when the song or artist added in [Favorites] menu is playing on other channel.

1. Press [Active] on the favorites list.

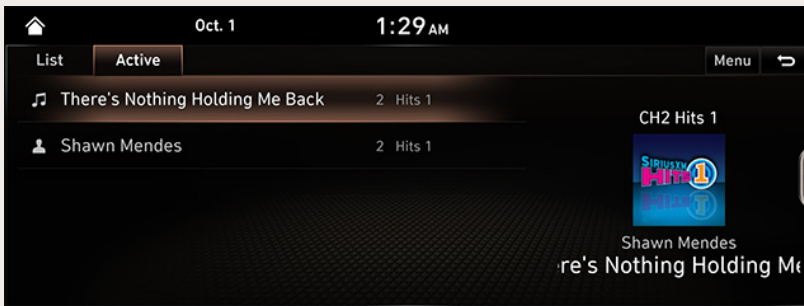

2. Listen to live broadcast by selecting the desired item.



DELETING THE SONG OR ARTIST SAVED IN [FAVORITES] MENU

1. Press [Menu] > [Delete] on the favorites menu.

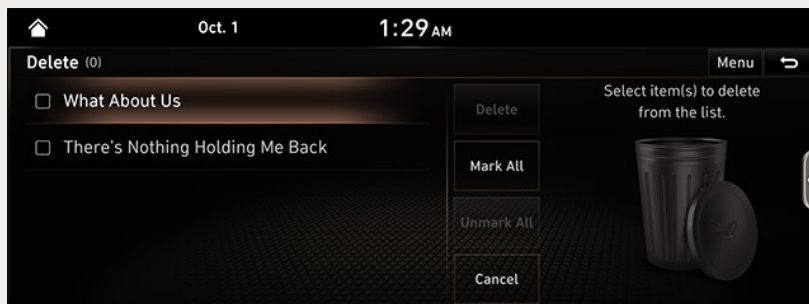

2. Select the desired item, then press [Delete].
 - [Mark All]: Marks all items.
 - [Unmark All]: Unmarks all items.
 - [Cancel]: Exits delete screen.



FAVORITES ALERT ON/OFF

This feature sets whether to display the pop-up on the screen when the song or artist added in [Favorites] menu is playing on other channel.

1. Press [Menu] > [More Features] > [Favorites Alert] on the SiriusXM radio screen.

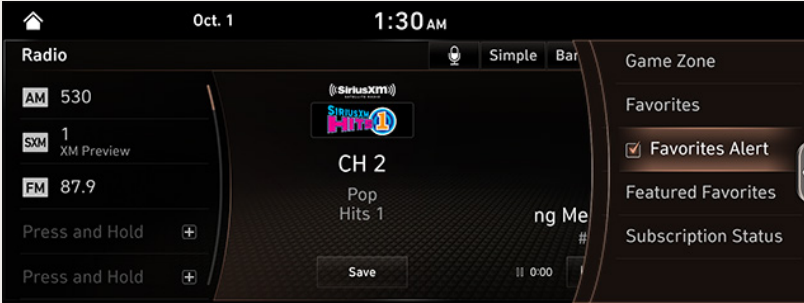

Pressing the [Favorites Alert] again will cancel the function.

2. When the song or artist saved in [Favorites] menu is playing on other channel, the pop-up is displayed on the screen.

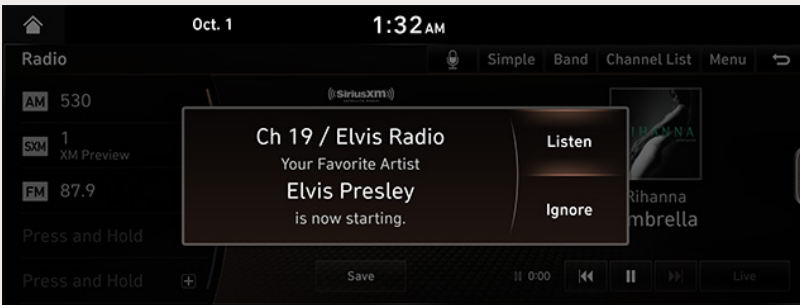

- [Listen]: Moves to the selected channel.
- [Ignore]: Moves to the previous screen.



FEATURED FAVORITES

Featured Favorites allows SiriusXM to broadcast additional presets.

1. Press [Menu] > [More Features] > [Featured Favorites] on the SiriusXM radio screen.

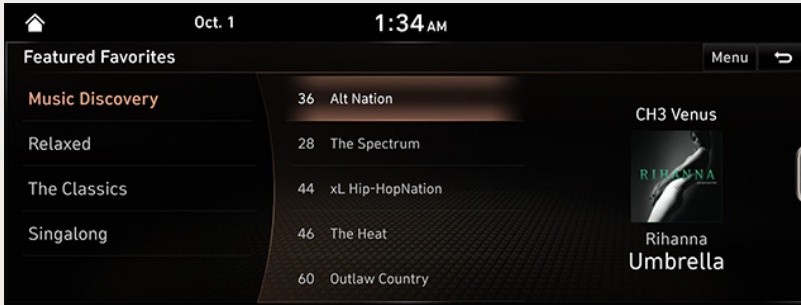

- Example 1 : “Martha’s Favorites” may represent Martha Stuart’s favorites presets on her radio.
- Example 2 : During holidays, “Holiday Music” may represent all the SiriusXM channels that are playing the holiday music for easy access by users

Multiple sets Featured Favorites data can be broadcast by SiriusXM and can change from time to time.

SUBSCRIPTION STATUS

This feature is used to check the Subscription status of SiriusXM.

1. Press [Menu] > [More Features] > [Subscription Status] on the SiriusXM radio screen.

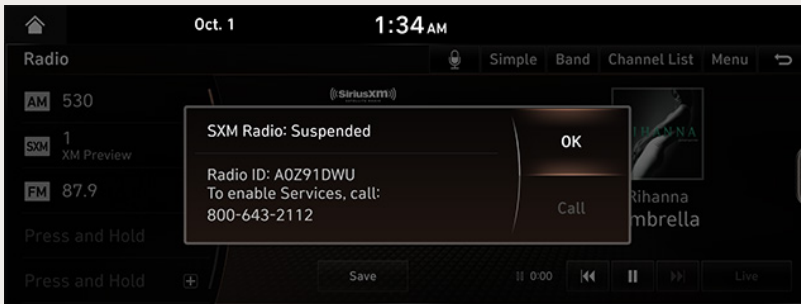

2. If you have not subscribed to the SiriusXM service, press [Call] to enable Services.

PHONE





BLUETOOTH

BLUETOOTH® WIRELESS TECHNOLOGY

WHAT IS BLUETOOTH WIRELESS TECHNOLOGY?

- Bluetooth Wireless Technology refers to a short-distance wireless networking technology which uses a 2.45GHz frequency to connect various devices within a certain distance.
- Supported within PCs, external devices, Bluetooth phones, PDAs, various electronic devices, and automotive environments, Bluetooth Wireless Technology to be transmitted at high speeds without having to use a connector cable.
- Bluetooth Hands-free refers to a device which allows the user to conveniently make phone calls with Bluetooth mobile phones through the system.
- The Bluetooth Hands-free feature may not be supported in some mobile phones.

PRECAUTIONS FOR SAFE DRIVING

- Bluetooth is a feature that enables drivers to use handsfree while driving. Connecting the head unit with a Bluetooth phone allows the user to conveniently make calls, receive calls, and manage the phone book. Before using Bluetooth Wireless Technology, carefully read the contents of this user's manual.
- Excessive use or operations while driving may lead to negligent driving practices and be the cause of accidents. Do not operate the device excessively while driving.
- Viewing the screen for prolonged periods of time is dangerous and may lead to accidents. When driving, view the screen only for short periods of time.



CAUTIONS UPON CONNECTING BLUETOOTH PHONE

- Before connecting the head unit with the mobile phone, check to see that the mobile phone supports Bluetooth features.
- If you do not want automatic connection with your Bluetooth device, turn the Bluetooth feature off of the Bluetooth device.
- Park the vehicle when pairing the head unit with the mobile phone.
- Some Bluetooth features may occasionally not operate properly depending on the firmware version of your mobile phone. If such features can be operated after receiving a S/W upgrade from your mobile phone manufacturer, unpair all devices and pair again before use.
- When pairing and the head unit with the iPhone for the first time while your iPhone is connected to the USB port with iPhone cable, error message may be displayed on your iPhone. But, this is intended operation. You may ignore it if your iPhone has been connected to the head unit.



PAIRING AND CONNECTING THE UNIT AND A BLUETOOTH PHONE

To use the Bluetooth feature, make sure the Bluetooth on your phone is turned on. Refer to your phone's user guide.

WHEN NO PHONES HAVE BEEN PAIRED

1. Press on the steering wheel remote control or [Phone] on the HOME screen.



2. Search and select the vehicle name on Bluetooth device registration waiting screen. (The default vehicle name is **GENESIS G90**.)

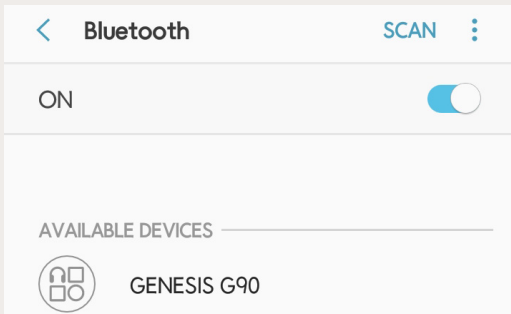

<Example of Bluetooth device screen>

(The pop-up screen may differ from the actual information of the Bluetooth device.)



3. If SSP (Secure Simple Pairing) is supported, authorize the registration on the Bluetooth device.

Bluetooth pairing request

Passkey: 2b7454

Pair with GENESIS G90?

CANCEL OK

<Example of Bluetooth Device Screen>

4. A message that approves the access request to the contacts and the call history of the Bluetooth device is displayed.

Allow access to contacts?

GENESIS G90 is requesting
permission to access your contacts
and call history.

You can change this later in
Bluetooth settings.

DENY ALLOW

<Example of Bluetooth Device Screen>

(The pop-up screen may differ from the actual information of the Bluetooth device.)



5. A message that request for the access to messages of the Bluetooth device is displayed.

Allow access to messages?

GENESIS G90 is requesting permission to access your messages.

You can change this later in Bluetooth settings.

DENY

ALLOW

<Example of Bluetooth Device Screen>

NOTE

- The initial vehicle name is registered as [GENESIS G90] with the authentication passkey of '0000'.
- Depending on the Bluetooth device, authentication passkey may or may not be required.
- Depending on the Bluetooth device, Android or iOS phone, the message may appear differently. For iOS phones, select [Settings] > [Bluetooth] > [> [Show Notification].
- If SSP (Secure Simple Pairing) is not supported, process the registration after entering the authentication passkey on the Bluetooth Device.



6. When the connection is completed, the recent call screen is displayed on the screen. When the connection fails, a failure message is displayed on the screen.

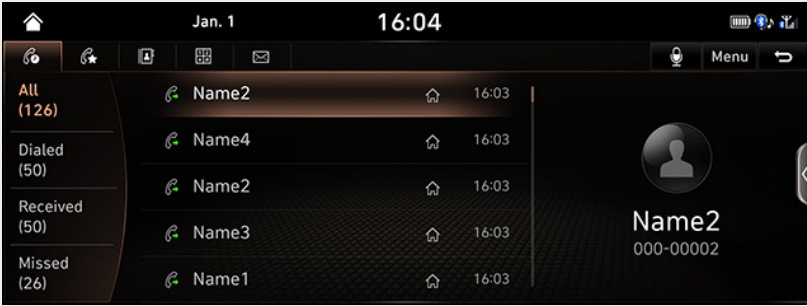

<Recent calls Screen>

WHEN A PHONE IS ALREADY PAIRED

1. Press  > [Setup] > [Bluetooth] > [Bluetooth Connections].



2. Select the device you want to connect. If there is no device you want to connect, press [Add New Device].



3. Search and select the vehicle name on Bluetooth device registration waiting screen. (The default vehicle name is **GENESIS G90**.)

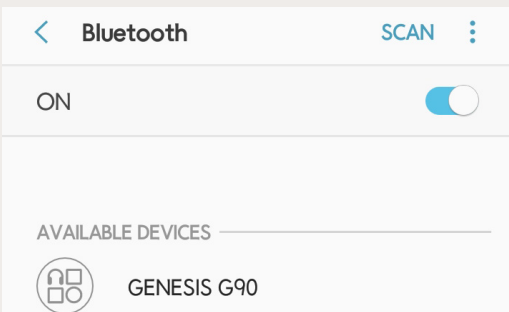

<Example of Bluetooth device screen>

(The pop-up screen may differ from the actual information of the Bluetooth device.)



- If SSP (Secure Simple Pairing) is supported, authorize the registration on the Bluetooth device.

Bluetooth pairing request

Passkey: 2b7454

Pair with GENESIS G90?

CANCEL OK

<Example of Bluetooth Device Screen>

(The pop-up screen may differ from the actual information of the Bluetooth device.)

- A message that approves the access request to the contacts and the call history of the Bluetooth device is displayed.

Allow access to contacts?

GENESIS G90 is requesting
permission to access your contacts
and call history.

You can change this later in
Bluetooth settings.

DENY ALLOW

<Example of Bluetooth Device Screen>

(The pop-up screen may differ from the actual information of the Bluetooth device.)



6. A message that request for the access to messages of the Bluetooth device is displayed.

Allow access to messages?

GENESIS G90 is requesting permission to access your messages.

You can change this later in Bluetooth settings.

DENY

ALLOW

<Example of Bluetooth Device Screen>

NOTE

- The initial vehicle name is registered as [GENESIS G90] with the authentication passkey of '0000'.
- Depending on the Bluetooth device, the authentication passkey may or may not be required.
- Depending on the Bluetooth device, Android or iOS phone, the message may appear differently. For iOS phones, select [Settings] > [Bluetooth] > [] > [Show Notification].
- If SSP (Secure Simple Pairing) is not supported, process the registration after entering the authentication passkey on the Bluetooth Device.



7. When the connection is completed, the [Bluetooth Settings] screen is displayed on the screen. When the connection fails, a failure message is displayed on the screen.



<[Bluetooth settings screen]>

! NOTE

- For safety reasons, pairing a Bluetooth phone is not possible when the vehicle is in motion. Park the vehicle in a safe location to pair a Bluetooth phone. It is possible to pair up to 5 mobile phones. In order to pair a new phone when there are already 5 mobile phones paired, you must first delete one of the previously paired phones.
- Some functions may not be supported due to limited Bluetooth compatibility between the car system and mobile phone.
- When a Bluetooth device is connected, a new device cannot be paired. If you want to pair a new phone, first disconnect the connected Bluetooth device.



DISCONNECTING THE CONNECTED PHONE

1. Press [] on the steering wheel remote control or [Phone] on the HOME screen.
2. Press [Menu] > [Bluetooth Settings] > [Bluetooth Connections] on the screen.
3. Select the connected phone.

NOTE

If you want to connect the disconnected phone again, select the disconnected phone.



DELETING BLUETOOTH DEVICES

If you no longer need to use a phone, you can delete the Bluetooth devices. Note that deleting a Bluetooth device will delete all call history and contact entries.

1. Press [⏏] on the steering wheel remote control or [Phone] on the HOME screen.
2. Press [Menu] > [Bluetooth Settings] > [Bluetooth Connections] on the screen.
3. Press [Menu] > [Delete].

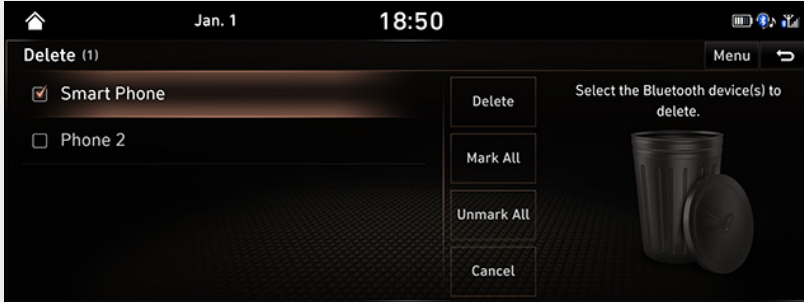

4. Select the phone you want to delete and press [Delete].
 - [Mark All]: Marks all items.
 - [Unmark All]: Unmarks all items.
 - [Cancel]: Exits delete screen.
5. Press [Yes] on the pop-up screen.

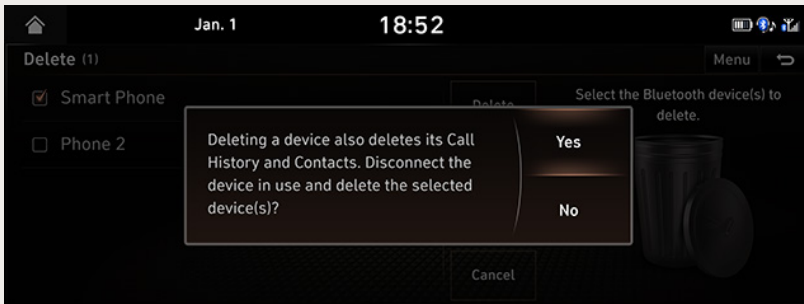



BLUETOOTH SETTINGS

1. Press [] on the steering wheel remote control or [Phone] on the HOME screen.
2. Press [Menu] > [Bluetooth Settings].



3. For more details, refer to the "Bluetooth" part.



MAKING A CALL



MAKING A CALL BY ENTERING PHONE NUMBER

Connect your unit and Bluetooth phone before making a call.

1. Press  on the screen.



<Dial screen>

2. Enter the phone number using the keypad on the dial screen.
3. Press  on the dial screen or  on the steering wheel remote control.

NOTE

If you press the wrong number, press  to delete the inputted number one digit at a time.



MAKING A CALL BY VOICE RECOGNITION

1. Press  on the screen. The system waits for your command and displays a list of available commands on the screen.



2. If you hear a beep sound after voice guidance, say 'Name1'.

MAKING A CALL BY REDIALING

Press and hold  on the dial screen or  on the steering wheel remote control.

! NOTE

Redialing is not possible when there is no dialed call history.

MAKING A CALL WITH SPEED DIAL NUMBERS

Press and hold speed dial number using the keypad on the dial screen.

Only speed dial numbers already saved on the mobile phone can be used for speed dial calls. Up to 3-digit speed dial numbers are supported.

! NOTE

For 3-digit speed dial numbers, press and hold the 3rd digit to make a call to the speed dial number.



ANSWERING/REJECTING A CALL

1. If there is an incoming call, a popup message will appear.
2. Press [Accept] to answer the call.

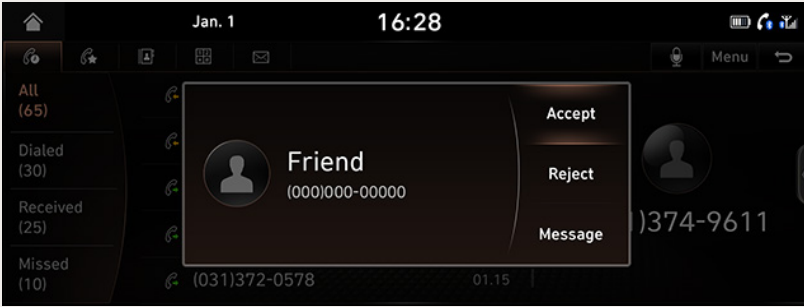

To reject a call, select [Reject].

! NOTE

- If the Call-ID service is available, the caller's phone number is displayed.
- If caller's phone number is saved in the phone book, the caller's name is displayed on the unit.
- Upon receiving a call, the [Reject] function may not be supported in some mobile phones.

RESPONDING WITH MESSAGES

1. If there is an incoming call, a popup message will appear.

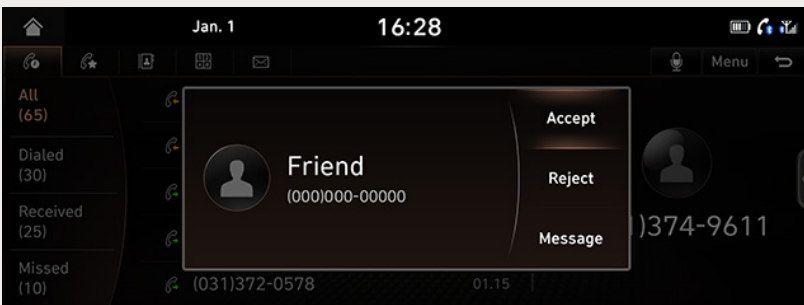



- Press [Message] to respond with messages

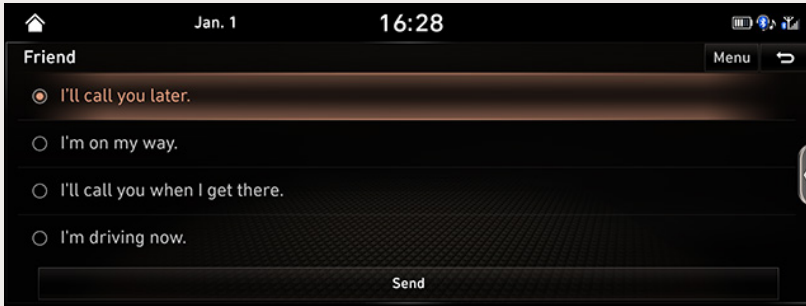

- Select the desired message and press [Send].

NOTE

Depending on the mobile phone model, the [Message] function may not be supported.

SWITCHING CALL TO THE MOBILE PHONE

- If you want to switch the call to the mobile phone while talking on the car handsfree, press [Use Private]. As shown below, the call is switched to the mobile phone

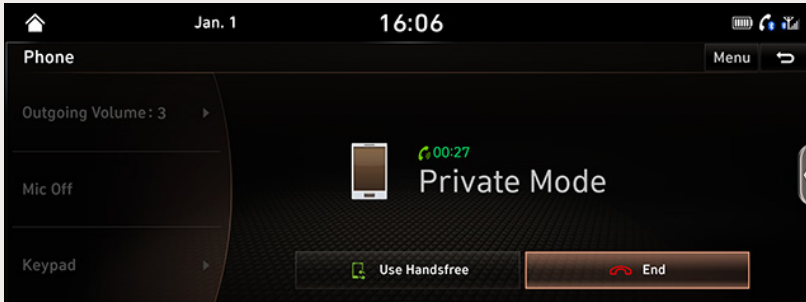

- If you want to switch the call to the car handsfree while talking on the mobile phone, press [Use Hands-free]. The call is switched to the car handsfree.

ENDING A CALL

- To end a call, press [End] on the screen or [End] on the steering wheel remote control.
- The call is ended.



USING THE MENU DURING A PHONE CALL

When making a call, you can use the following menu items.

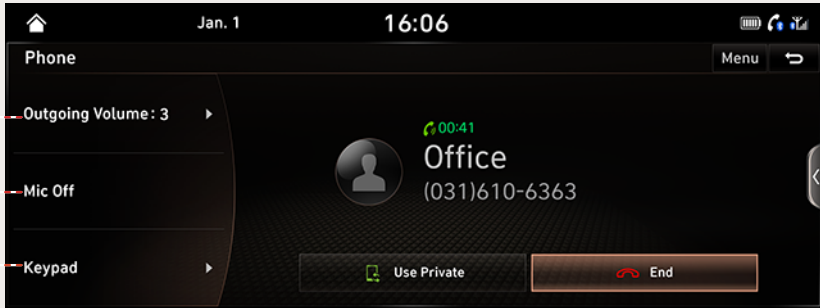

1 Outgoing Volume

Displays the Outgoing Volume settings. You can adjust the in-call volume that the other party hears (level 1 - 5).

2 Mic On/Off

Turns the Mic On/Off.

3 Keypad

Moves to a screen for entering ARS numbers.



CALL HISTORY

MAKING A CALL FROM CALL HISTORY

1. Press  on the screen.

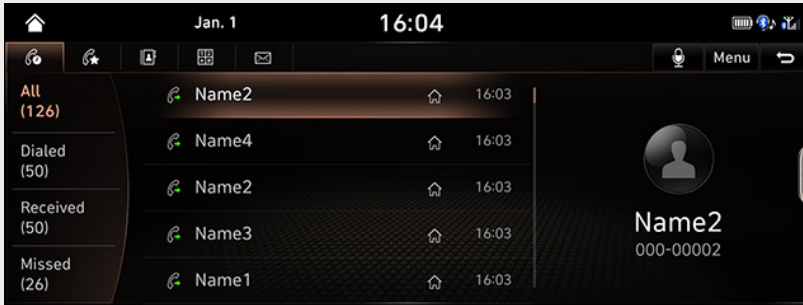

2. Press [All], [Dialed], [Received], or [Missed].
 - [All]: Displays entire call history list.
 - [Dialed]: Displays the outgoing call history list.
 - [Received]: Displays the incoming call history list.
 - [Missed]: Displays the missed call history list.
3. Press the entry you want to call.

NOTE

The call history may not be saved in the call history list in some mobile phones.



DOWNLOADING CALL HISTORY

You can download the call history information from your mobile phone.

1. Press > [Menu] > [Download] on the screen.

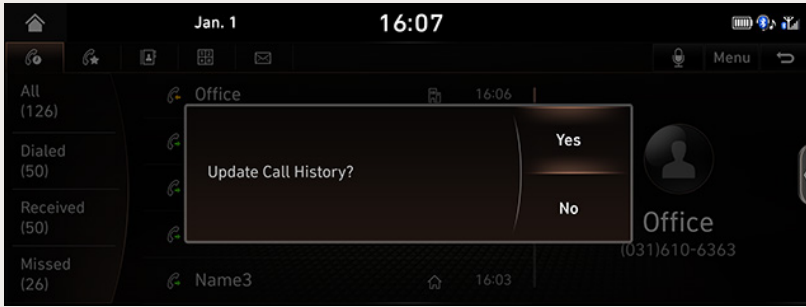

2. Press [Yes].

NOTE

- Up to 50 received, diald, and missed call history lists can be downloaded.
- The download feature may not be supported in some mobile phones. Check to see that the Bluetooth device supports the download feature.



CONTACTS

MAKING A CALL FROM CONTACTS

1. Press **[☰]** on the screen. The contacts are displayed on the screen.

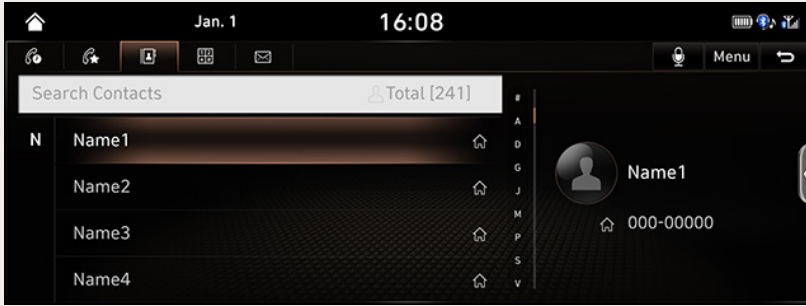

<Contacts screen>

2. Press the phone number to make a call.



DOWNLOADING MOBILE PHONE CONTACTS

Up to 5,000 mobile phone contacts can be downloaded.

The phonebook download feature will only download contacts transmitted via Bluetooth (contacts saved on a Bluetooth device or on the SIM card). Contacts saved in a third-party app or contacts without a phone number will not be downloaded.

1. Press **[☰]** > [Menu] > [Download] on the screen.

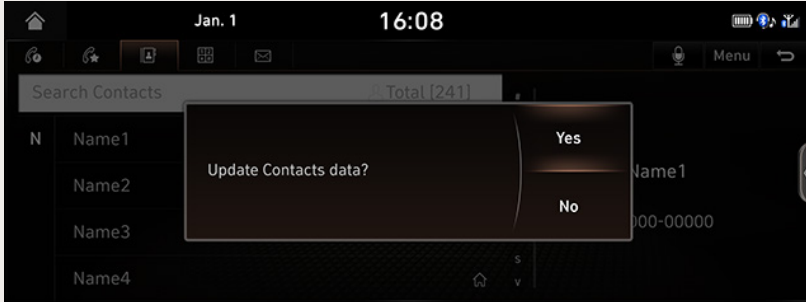

2. Press [Yes].

The present phone book is deleted and phone book of connected phone is duplicated.

! NOTE

- Upon downloading mobile phone contacts, the previous data is deleted.
- This feature may not be supported on some mobile phones.



SEARCHING FOR CONTACTS

1. Press > [Menu] > [Search Contacts] on the screen.



2. Enter the name or phone number, press .

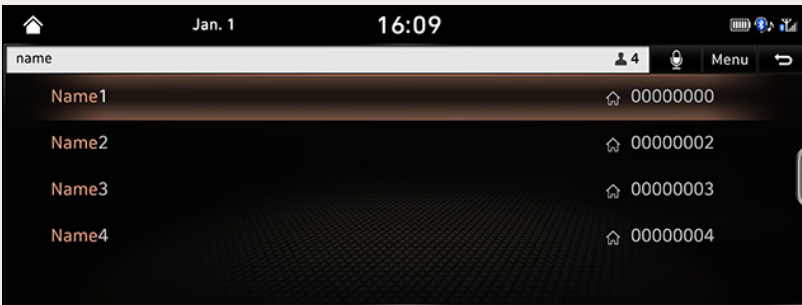

3. Select the contact you want to call.



FAVORITE CONTACTS

CALLING FAVORITES

If the phone number has been already stored in the Favorites, it can be easily called. First of all, add the phone number in the Favorites.

1. Press  on the screen.

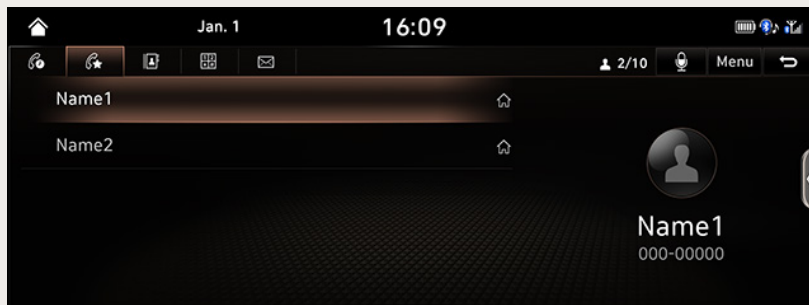

<Favorite screen>

2. Select the desired Favorite.



ADDING AS A FAVORITE

Up to 10 contacts can be added to favorites menu.

1. Press [] on the screen.
2. Press [Menu] > [Add New] on the Favorites screen.

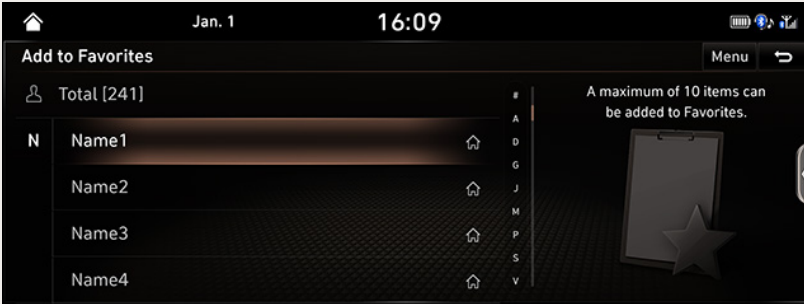

3. Select the contact from the list of contacts.

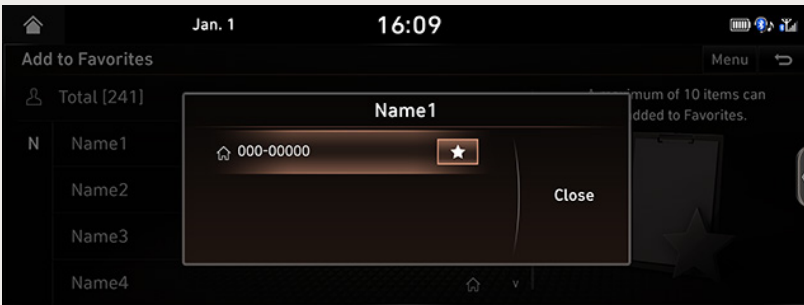

4. Press [] > [Close] > [].

NOTE

If the phone numbers have already been stored in the favorites, you can add or delete them by pressing [Menu] > [Edit].



EDITING FAVORITES

1. Press on the screen.
2. Press [Menu] > [Edit] on the Favorites screen.

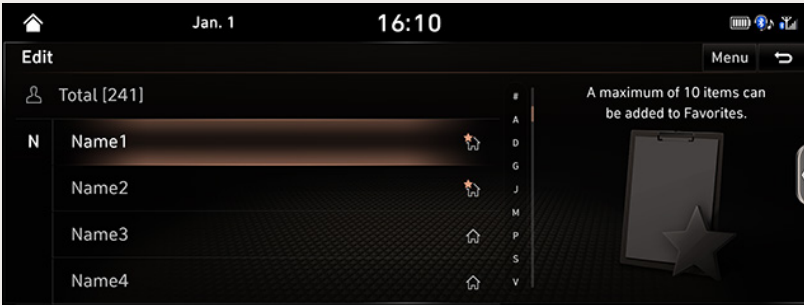

3. Select the contact to edit.



4. Press or .
 - : Contact added to favorites.
 - : Contact not added to favorites.
5. Press [Close] > .



DELETING FAVORITES

1. Press  on the screen.
2. Press [Menu] > [Delete] on the Favorites screen.

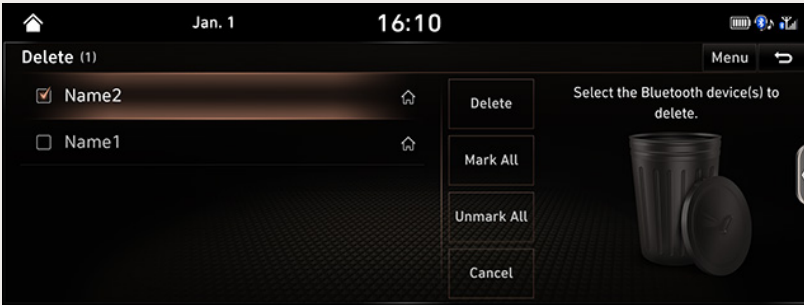

3. Select the item you want to delete and press [Delete] > [Yes].
 - [Mark All]: Marks all items.
 - [Unmark All]: Unmarks all items.
 - [Cancel]: Exits delete screen.



DIAL SCREEN

Press  on the screen.

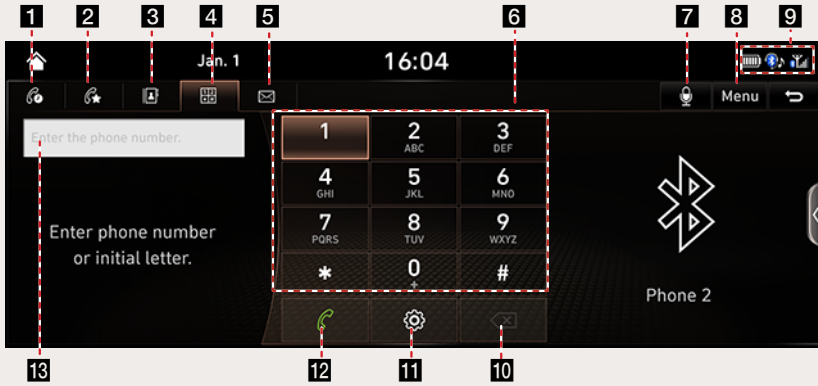

1 (Recent calls)

Moves to recent calls screen.

2 (Favorites)

Moves to favorites Screen.

3 (Contacts)

Moves to contacts screen.

4 (Phone screen)

Moves to Bluetooth phone dial pad screen.

5 (Message)

Moves to message screen.

6 Dial pad

Enter the phone number you want to call. It will be displayed in the number entrance window.

7 (Voice Recognition)

Moves to Voice Recognition.

8 Menu



Displays popup menu of each mode.

9 (Mobile battery icon)

Specifies the remaining battery of mobile phone.

** (Bluetooth connection icon)**

Shows the connection status between Bluetooth phone and the head unit.

When the phone is connected and the phone call is made, Bluetooth icon () switches to handset icon ()

 (Reception level icon)

The reception level (sensitivity) of the calling area is specified in the bar graph.

10  (Delete)

Deletes the entered phone no.

11  (Setting)

Moves to Bluetooth setting screen.

12  (Call)

If there is a registered phone no., the call is connected. If there is no registered phone no., the most recent call number is entered.

13 Number entrance window

Opens phone number entrance window.

 NOTE

- Some mobile phone models may not support the icons of remaining battery and/or reception level.
- The remaining battery specified may differ in a little degree from the one specified on the phone.



MESSAGES

You can check the text messages or send any message on the screen.

CHECKING NEW MESSAGES

1. When a message is received, the pop-up is displayed on the screen.

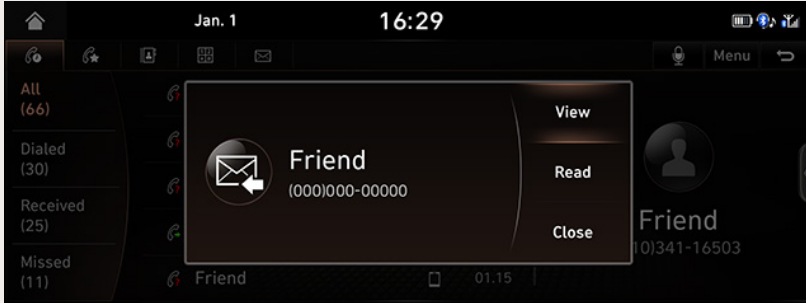

2. Select a desired item.
 - [View]: Moves to the message screen.
 - [Read]: Supports the message contents by voice.
 - [Close]: Closes the message pop-up.

NOTE

Change the setting of [Show Notifications] of the device connected in Bluetooth Setting of Mobile Phone to 'On'.



CHECKING NEW MESSAGE CONTENTS

1. Press  on the screen.

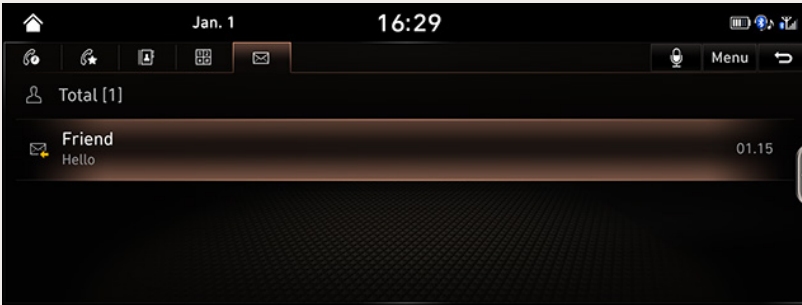

2. Select a message.

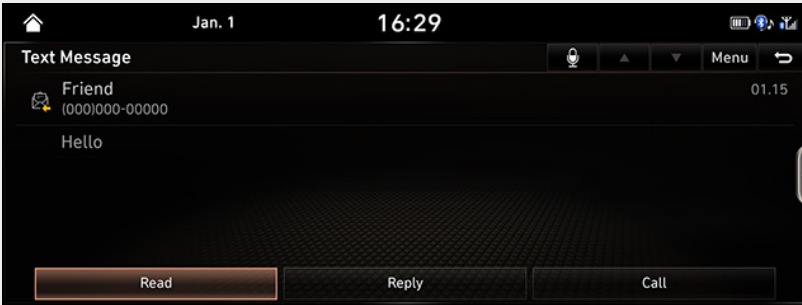

3. Check the information on message.
 - [Read]: Supports the message contents by voice.
 - [Reply]: Replies to the message.
 - [Call]: Calls the message sender.

NOTE

- Only the messages received after the Bluetooth connection are specified in the list.
- Depending on the mobile phone model, [Read], [Reply] and [Call] functions may not be supported.

SYSTEM





VEHICLE

This menu describes vehicle settings.

Depending on the condition of the vehicle controller, some menus may not be displayed.

HEAD-UP DISPLAY

1. Press [HOME] or > [Setup] > [Vehicle] > [Head-Up Display].



2. Select the desired items.

ENABLE HEAD-UP DISPLAY

It displays the head-up display information on the windshield.

DISPLAY CONTROL

You can adjust the [Display height], [Rotation], and [Brightness].

CONTENT SELECTION

You can set the display such as [Turn info], [Traffic Signs], [Driving assist info], [Lane safety info], [Blind-spot safety info].

SPEEDOMETER

- [Number size]: You can set the number size of the head-up display on the windshield to [Small], [Medium], or [Large].
- [Speedometer color]: You can set the speedometer color of the head-up display on the windshield to [Orange], [White], or [Green].



DRIVE MODE

1. Press [HOME] or > [Setup] > [Vehicle] > [Drive Mode].

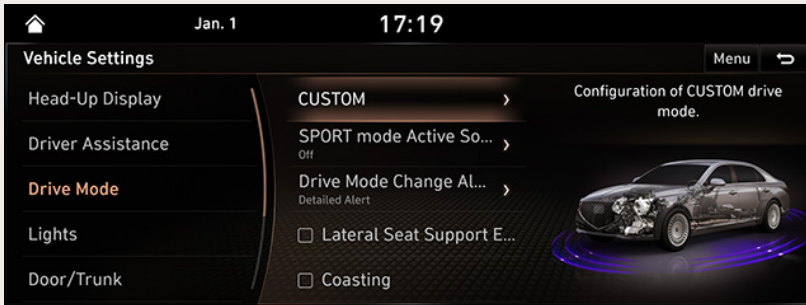

2. Select the desired items.

CUSTOM

It configures the drive mode based on user selections.

Powertrain

- [ECO]: Selects the optimized mode for fuel efficient driving.
- [Comfort]: Selects the optimized mode for balance comfort driving.
- [Sport]: Selects the optimized mode for dynamic driving.
- [SMART]: Automatic adjustment-ECO/COMFORT/SPORT.

Steering

- [Comfort]: Selects the smooth steering wheel mode.
- [Sport]: Selects the agile steering wheel mode.

Suspension

- [Comfort]: Selects the optimized mode for balanced comfort.
- [SPORT]: Selects the optimized mode for dynamic driving.

AWD

- [ECO]: Selects the optimized mode for fuel efficient driving.
- [Comfort]: Selects the optimized mode for balanced comfort.
- [Sport]: Selects the optimized mode for dynamic driving.

SPORT MODE ACTIVE SOUND DESIGN

It configures the engine sound mode. Select [Strong], [Normal], [Minimised] or [Off].



DRIVE MODE CHANGE ALERT

The information, which will be shown whenever the drive mode is changed.

- [Detailed Alert]: A change of the drive mode is shown by an image of the vehicle.
- [Simple Alert]: A change of the drive mode is indicated by a short message on top of the screen.
- [Off]: A change of the drive mode is not indicated.

LATERAL SEAT SUPPORT ENHANCEMENT

Increases lateral seat bolster support when SPORT mode is selected.

ECO COASTING

Engine is decoupled from transmission during vehicle coasting for better fuel economy in ECO and SMART drive modes.

LIGHTS

1. Press [HOME] or  > [Setup] > [Vehicle] > [Lights].



2. Select the desired items.

AMBIENT LIGHT

It sets the ambient light.

- [Brightness]: It sets the brightness of ambient light.
- [Color]: It sets the color of ambient light.

ONE TOUCH TURN SIGNAL

The number of times the turn indicator flashes when the turn signal lever is moved slightly. Select [3 flashes], [5 flashes], [7 flashes] or [Off].

HEADLIGHT DELAY

After the ignition is turned off, the lights turn off after approximately 15 seconds.



DOOR/TRUNK

1. Press [HOME] or > [Setup] > [Vehicle] > [Door/Trunk].



2. Select the desired items.

AUTO LOCK

It selects a condition for all doors to be locked automatically. Select [Enable on speed], or [Enable on shift].

AUTO UNLOCK

It selects a condition for all doors to be unlocked automatically. Select [vehicle Off], [On shift to P] or [Off].

2 PRESS UNLOCK

All doors are unlocked when the unlock button on the key is pressed twice.

POWER TRUNK OPENING HEIGHT

Select the opening height of the power trunk. Select [100%] or [50%].

SMART TRUNK

The trunk lid will automatically open when approaching the trunk with the smart key.



CLUSTER

1. Press [HOME] or > [Setup] > [Vehicle] > [Cluster].

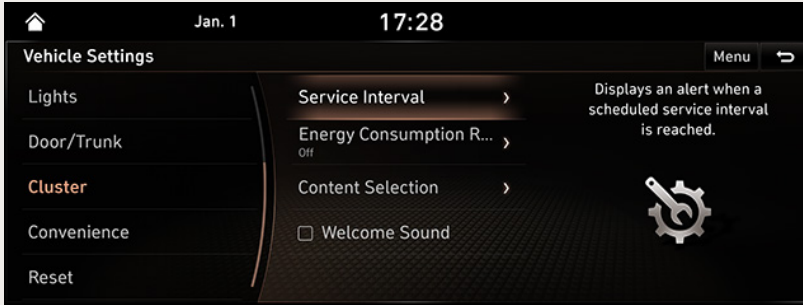

2. Select the desired items.

SERVICE INTERVAL

Mark [Enable Service interval]. An alert is displayed when a specified service interval is due.

- [Distance]: It sets service interval distance to (mi).
- [Duration]: It sets service interval period to (days).
- [Reset]: It initializes service interval.

ENERGY CONSUMPTION RESET

It selects a condition for automatically resetting the fuel economy average.

- [After Ignition]: It resets the fuel economy average automatically every time you turn on the ignition.
- [After Refueling]: It resets the fuel economy average automatically every time you refuel.
- [Off]: It turns off fuel economy average auto reset time point.

CONTENT SELECTION

It selects the content to be displayed in the cluster.

- [Gear Position Pop-up]: It displays a pop-up when gear position is changed.
- [Wiper/Lights Display]: It displays wiper/light mode screen when controlling wiper/light levers.
- [Traffic Signs]: It displays traffic information such as speed limits.
- [Icy Road Warning]: A warning is given, when the outside temperature is below 4°C and the road conditions may be icy.

WELCOME SOUND

Greeting chime when the cluster turns On or Off.



CONVENIENCE

1. Press [HOME] or > [Setup] > [Vehicle] > [Convenience].

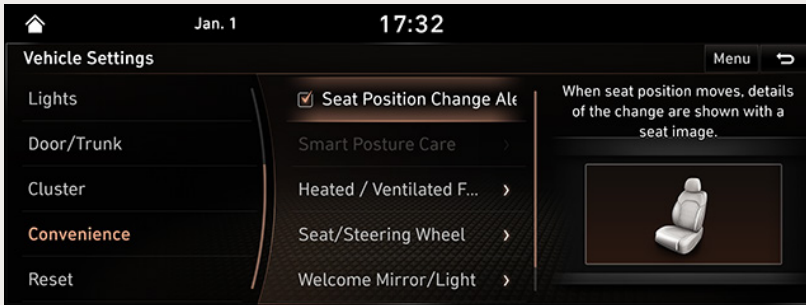

2. Select the desired items.

SEAT POSITION CHANGE ALERT

It displays the information on the changing of the seat position.

SMART POSTURE CARE

The smart posture care suggests driving postures based on body type and displays the results of clinical testing on the back.

- [Enter driver's information]: Set the height, the pants inseam length and the weight.
- [Save Current Posture]: Select [Driver 1] or [Driver 2].

HEATED/VENTILATED FEATURES

- [Auto Comfort Control]
 - [Seat Warmer/Ventilation]: Driver seat warmer/ventilation adjusts automatically to maintain driver comfort.
 - [Steering Wheel Warmer]: Steering wheel warmer adjusts automatically to maintain driver comfort.
- [Auto Heater Control]
 - [Steering Wheel]: Steering wheel warmer is automatically reduced for proper temperature.
 - [Driver Seat]: Driver Seat warmer is automatically reduced for proper temperature.
 - [Passenger]: Passenger Seat warmer is automatically reduced for proper temperature.
 - [Rear Left]: Rear Left Seat warmer is automatically reduced for proper temperature.
 - [Rear Right]: Rear Right Seat warmer is automatically reduced for proper temperature.



SEAT/STEERING WHEEL

- [Steering Wheel Easy Access]: Automatic movement of the steering wheel when the driver enters/exits the vehicle.
- [Seat Easy Access]: Movement distance of the seat when the driver enters/exits the vehicle. Select [Off], [Normal], or [Extended].

WELCOME MIRROR/LIGHT

- [Enable on Door Unlock]: The welcoming feature is enabled when the doors are unlocked.
- [Enable on Driver Approach]: The welcoming feature is enabled when the driver approaches the vehicle with the Smart key.

WIRELESS CHARGING SYSTEM

Wireless charging pad is enabled to be used with compatible devices.

- [Front]: Mobile phones that support wireless charging can be charged without a cable connection in front seat.
- [Rear]: Mobile phones that support wireless charging can be charged without a cable connection in rear seat.

RESET

This menu is used to reset [Vehicle] settings. Some items may not be reset.

1. Press [HOME] or  > [Setup] > [Vehicle] > [Reset].



2. Press [Yes].



NAVIGATION

This menu describes navigation settings.

DISPLAY

This menu is used to change the display environment settings.

1. Press [HOME] or > [Setup] > [Navigation] > [Display].



2. Select the desired items.
 - [Map Display]: Changes the map view perspective.
 - [3D Buildings]: Displays the 3D building in screen.
 - [Show Previous Destinations after Navigation Start-Up]: Changes the previous destination view setting when starting Navigation. When this is selected and when navigation is started without a route planned, a list of previous destination will be displayed.
 - [Auto Re-center Map]: Sets whether to return to the current position on the map automatically after scrolling the map.
 - [Save Previous Destinations]: Sets whether to automatically save a location in Previous Destinations.
 - [Speed Limit]: Sets whether to display the Speed Limit Guidance or not.
 - [Text Size]: Sets the map font size to [Small], [Medium] or [Large].
 - [GPS Information]: Checks the GPS information.



GUIDANCE

This menu is used to change the guidance settings.

1. Press [HOME] or > [Setup] > [Navigation] > [Guidance].



2. Select the desired items.
 - [Number of Guidance Prompts]: Sets the frequency of the route guidance to [Fewer] or [More].
 - [Set Guidance Distance]: Sets the method used to display distances in the turn-by-turn directions display. Select [Distance from Vehicle] or [Distance btwn Turns].
 - [Navigation Guidance Priority]: Sets whether to lower all other audio volumes when Navigation prompts are playing.
 - [Map Auto-scale Settings]: Sets the scales for each vehicle speed zone. For example, when you select "700ft" for the 21-40 mi/h zone and "0.25 mi" for the 41-60 mi/h zone, the unit interval for the map scale on the navigation screen becomes 700ft when the vehicle speed is 40 mi/h and 0.25 mi when the vehicle speed is 41mi/h.



TRAFFIC

1. Press [HOME] or > [Setup] > [Navigation] > [Traffic].

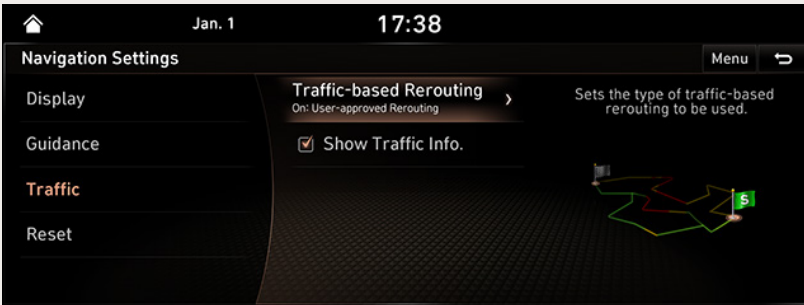

2. Select the desired item.
 - [Traffic-based Rerouting]: Sets the type of traffic-based rerouting to be used.
 - [Show Traffic Info.]: Shows traffic information.



RESET

This menu is used to reset all [Navigation] settings.

1. Press [HOME] or  > [Setup] > [Navigation] > [Reset].

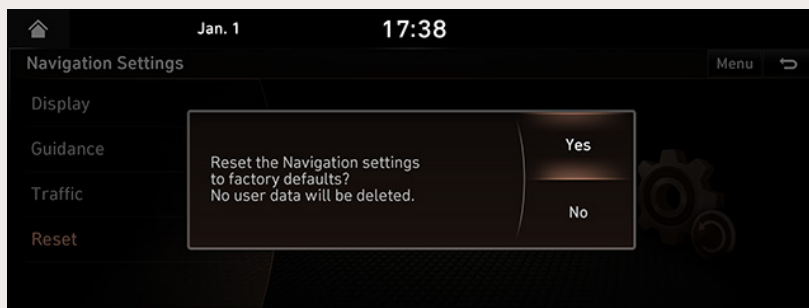

2. Press [Yes].

BLUETOOTH

This menu describes Bluetooth settings.

BLUETOOTH CONNECTIONS

Press [HOME] or  > [Setup] > [Bluetooth] > [Bluetooth Connections].

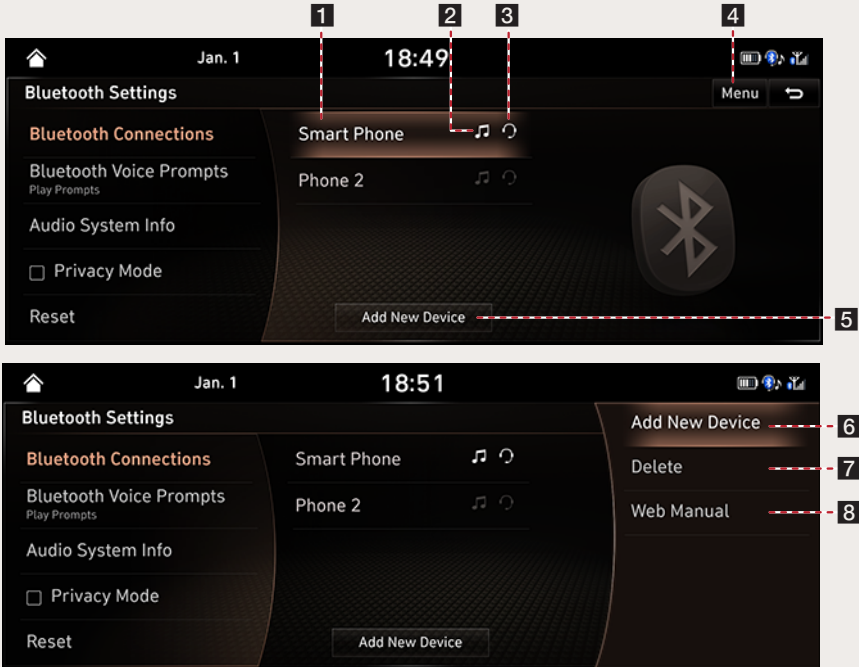

1 Paired device list

Displays the paired Bluetooth device list. When selecting from the list, the device is either connected or disconnected.

2 Bluetooth audio connection status

An icon appears when you make a Bluetooth audio connection.

3 Bluetooth hands-free connection status

An icon appears when you make a Bluetooth hands-free connection.

4 Menu

Displays the [Bluetooth Settings] menu.



5 Add New Device

Registers a new Bluetooth device.

6 Add New Device

Registers a new Bluetooth device.

7 Delete

Deletes the registered Bluetooth devices.

8 Web manual

Displays the QR code for the manual of corresponding function.

PREDEFINED MESSAGES

You can check and change the predefined messages.

1. Press [HOME] or > [Setup] > [Bluetooth] > [Predefined Messages].



2. Press [Replies for Text Messages] or [Replies for Rejected Calls].

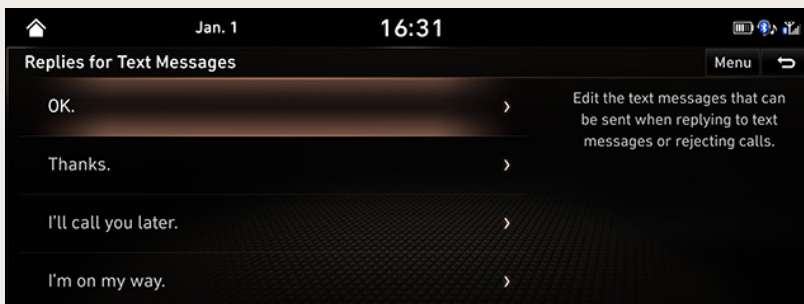



3. Select the desired message.



4. Change the message, and then press [].

 **NOTE**

Depending on the type of the connected Bluetooth device, the [Predefined Messages] function may not be supported.



BLUETOOTH VOICE PROMPTS

1. Press [HOME] or  > [Setup] > [Bluetooth] > [Bluetooth Voice Prompts].

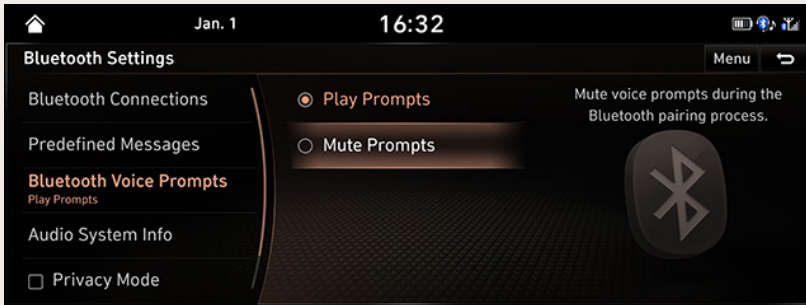

2. Select the desired option.
 - [Play Prompts]: Play voice prompts during the Bluetooth pairing process.
 - [Mute Prompts]: Mute voice prompts during the Bluetooth pairing process.



AUDIO SYSTEM INFO

This menu allows you to control additional Bluetooth® Wireless Technology related settings.

1. Press [HOME] or > [Setup] > [Bluetooth] > [Audio System Info].



2. Press the desired item.
 - [Vehicle Name]: Changes the Bluetooth device name of the vehicle.
 - [Passkey]: Changes the passkey required to connect a Bluetooth device to the car.

VEHICLE NAME

1. Press [HOME] or > [Setup] > [Bluetooth] > [Audio System Info] > [Vehicle Name].



2. Input the desired name using the keypad, then press [↵].

NOTE

The default vehicle name is set to GENESIS G90.



PASSKEY

The passkey is a 4-digit authentication code used for a Bluetooth connection between the mobile phone and car system. The default passkey is set to 0000.

1. Press [HOME] or > [Setup] > [Bluetooth] > [Audio System Info] > [Passkey].

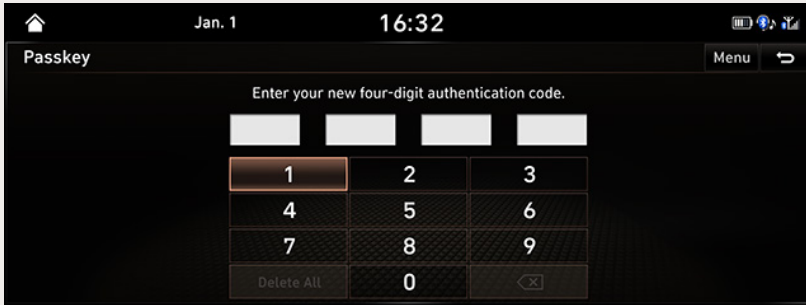

2. Change the authentication code using the keypad if needed.

PRIVACY MODE

Privacy mode is used to protect private information. If you activate Privacy Mode, the audio system will not display Contacts, Call History, Favorites, and Messages.

1. Press [HOME] or > [Setup] > [Bluetooth] > [Privacy Mode].

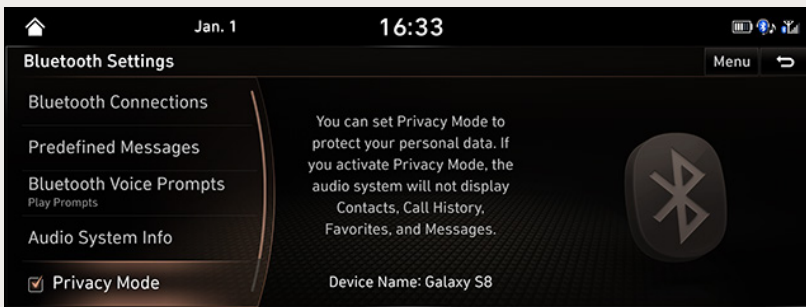

2. Mark or unmark [Privacy Mode].



RESET

This menu is used to reset Bluetooth settings to factory defaults.

1. Press [HOME] or  > [Setup] > [Bluetooth] > [Reset].



2. Press [Yes].



CONNECTED SETTINGS

This menu describes Connected Services settings.

ACTIVATE CONNECTED SERVICES

This menu is used to activate the Connected Services.

1. Press [HOME] or  > [Setup] > [Connected Services] > [Activate Connected Services].

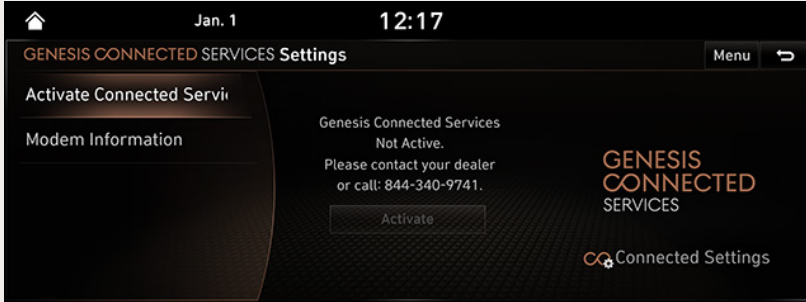

2. Select [Activate].

NOTE

If activation fails, contact the Connected Center at (844) 340-9741.



MODEM INFORMATION

This menu is used to check the Modem Information.

Press [HOME] or [] > [Setup] > [Connected Services] > [Modem Information].



PHONE PROJECTION

In this menu Android Auto and Apple CarPlay can be enabled by setting a checkmark.

1. Press [HOME] or  > [Setup] > [Phone Projection].



2. Press the desired feature.
 - [Enable Android Auto]: The system is now ready to recognize an Android Auto device and launch Android Auto functions, when connected via USB. Make sure that an up-to-date version of Android (Android 5.0 and later) is installed. Some features may not be available while using Android Auto.
 - [Enable Apple CarPlay]: The system is now ready to recognize an Apple CarPlay device and launch Apple CarPlay functions, when connected via USB. Make sure that an up-to-date version of iOS is installed. Some features may not be available.

NOTE

The [Phone Projection] settings cannot be changed while an external device is connected via USB.



ADVANCED

CUSTOM BUTTON

This menu is used to select a function you want to execute with the custom button.

1. Press [HOME] or  > [Setup] > [Advanced] > [Custom Button].

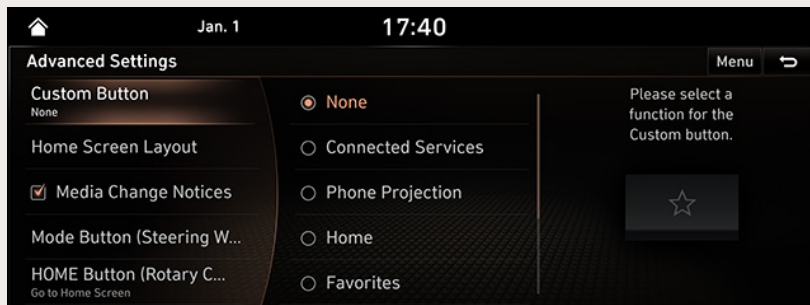

2. Press the desired feature.



HOME SCREEN LAYOUT

This menu is used to select Home screen widgets and rearrange menu icons.

1. Press [HOME] or  > [Setup] > [Advanced] > [Home Screen Layout].



2. Press [Edit].

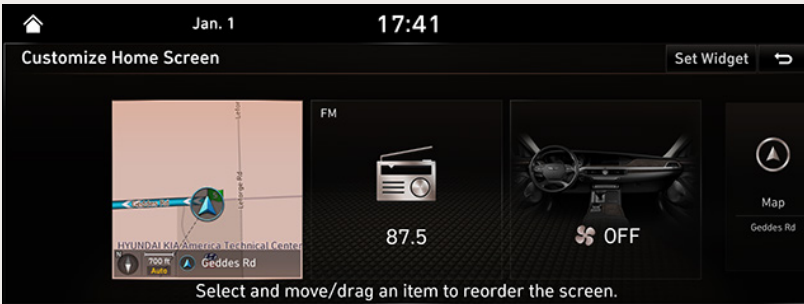

3. Press and drag an item to rearrange the screen.



MEDIA CHANGE NOTICES

This menu is used to display briefly media information whenever the content changes, except on Media playing screens.

Press [HOME] or > [Setup] > [Advanced] > [Media Change Notices].



MODE BUTTON (STEERING WHEEL)

This menu is used to access to selected media by using [MODE] button on the steering wheel remote control. Only active/available media can be accessed.

1. Press [HOME] or > [Setup] > [Advanced] > [Mode Button (Steering Wheel)].

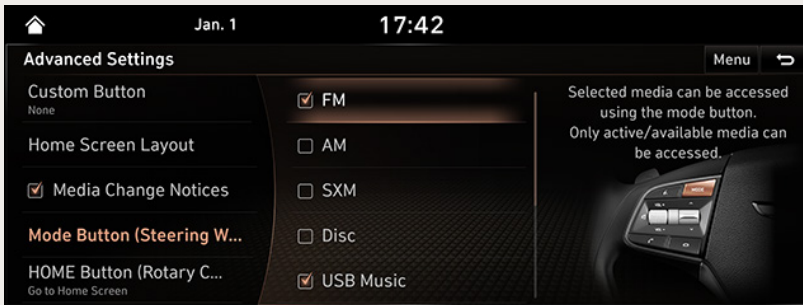

2. Select the desired features.



HOME BUTTON (ROTARY CONTROLLER)

This menu is used to set the function to be activated when the HOME button is pressed briefly.

1. Press [HOME] or > [Setup] > [Advanced] > [HOME Button (Rotary Controller)].

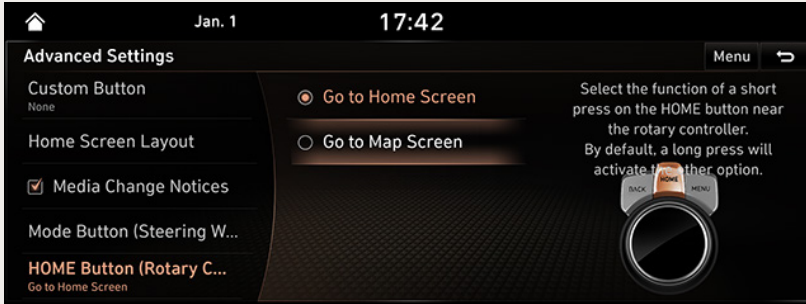

2. Press the desired item.
 - [Go to Home Screen]: Switches to HOME Screen when you press HOME button shortly.
 - [Go to Map Screen]: Moves to the map screen when HOME button is pressed shortly.



DATE/TIME

This menu describes Date/Time settings.

GPS TIME

This menu is used to display time according to the received GPS time.

Press [HOME] or [] > [Setup] > [Date/Time] > [GPS Time].

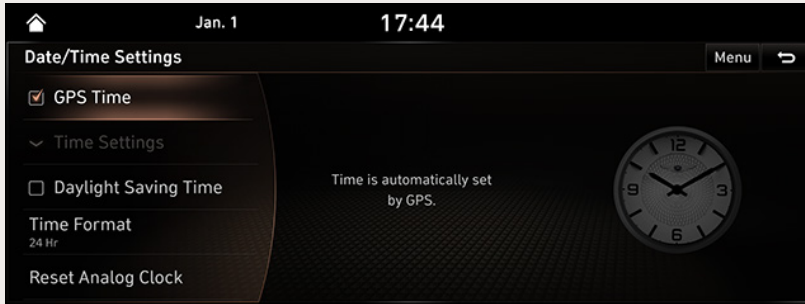

NOTE

When the GPS Time is turned off, you can set the time manually.



TIME SETTINGS

1. Press [HOME] or > [Setup] > [Date/Time] > [Time Settings].



2. Set the time, then press [OK].

NOTE

Time settings cannot be used when GPS time is set. To set the time manually, change [GPS Time] setting to off, and set the time.

DAYLIGHT SAVING TIME

This menu is used to turn on/off daylight saving time feature.

Press [HOME] or > [Setup] > [Date/Time] > [Daylight Saving Time].

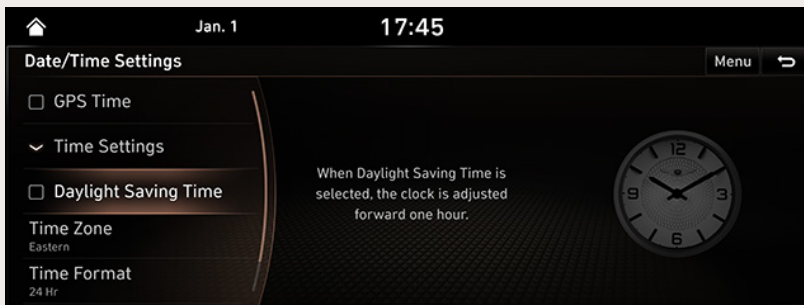

NOTE

- When [Daylight Saving Time] is turned on, the clock is adjusted forward one hour.
- The default settings of [Daylight Saving Time] is set to on.



TIME ZONE

This menu is used to select the time zone.

1. Press [HOME] or > [Setup] > [Date/Time] > [Time Zone].

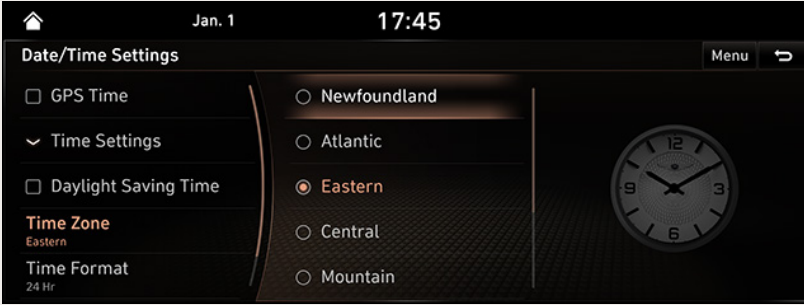

2. Select the desired time zone.

TIME FORMAT

This function is used to convert the digital clock display between 12 hour/ 24 hour systems.

1. Press [HOME] or > [Setup] > [Date/Time] > [Time Format].



2. Select [12 Hr] or [24 Hr].



RESET ANALOG CLOCK

This menu is used to resynchronizes the dashboard analog clock to match the audio system's digital clock.

1. Press [HOME] or > [Setup] > [Date/Time] > [Reset Analog Clock].



2. Select [Reset].



GENERAL

REAR DISPLAY ON/OFF (OPTION)

This menu is used to turn the screen for rear seat on/off.

1. Press [HOME] or  > [Setup] > [General] > [Rear display On/Off].



2. Press [Turn On] or [Turn Off].

LOCK REAR CONTROLS

This menu is used to disable the rear control.

Press [HOME] or  > [Setup] > [General] > [Lock Rear Controls].

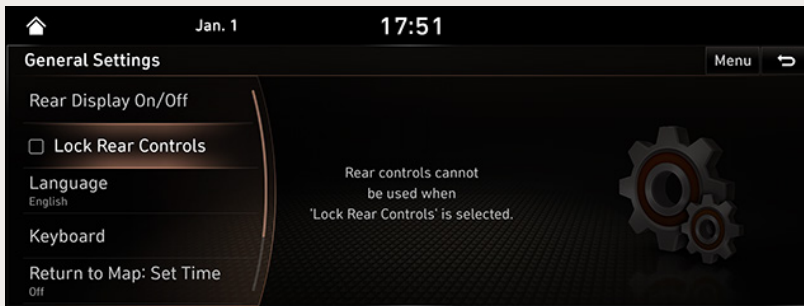



LANGUAGE

This menu is used to set the language of the system display and voice language.

1. Press [HOME] or > [Setup] > [General] > [Language].



2. Select the desired language.



KEYBOARD

This menu is used to change the type of keyboard used within the system for each language. The set keyboard will be applied to all input modes across the entire system.

1. Press [HOME] or > [Setup] > [General] > [Keyboard].



2. Select the keyboard type.

RETURN TO MAP: SET TIME

This menu is used to switch from Radio/Media to Map screen automatically after selected time.

1. Press [HOME] or > [Setup] > [General] > [Return to Map: Set Time].

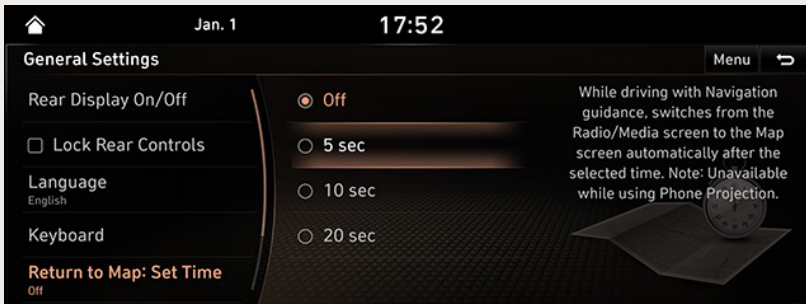

2. Select [Off], [5 sec], [10 sec] or [20 sec].



UNIT

This menu is used to change the type of unit used within the system.

1. Press [HOME] or > [Setup] > [General] > [Unit].



2. Press the desired item.

SCREEN SAVER

This menu is used to select the screen displayed when the system power is turned off.

1. Press [HOME] or > [Setup] > [General] > [Screen Saver].

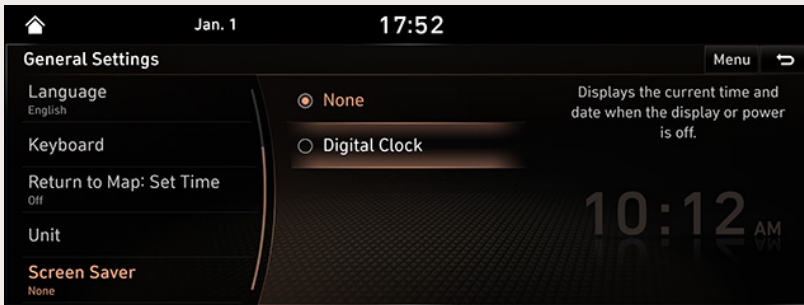

2. Press the desired item.
 - [None]: The system does not show any screen saver when the display or power is off.
 - [Digital Clock]: The current date and time are displayed when the display or power is off.

SOUND

This menu is used to adjust the sound effects for the whole system.

BEEP

This menu is used to play a beep sound whenever you operate the touch screen.

Press [HOME] or  > [Setup] > [Sound] > [Beep].

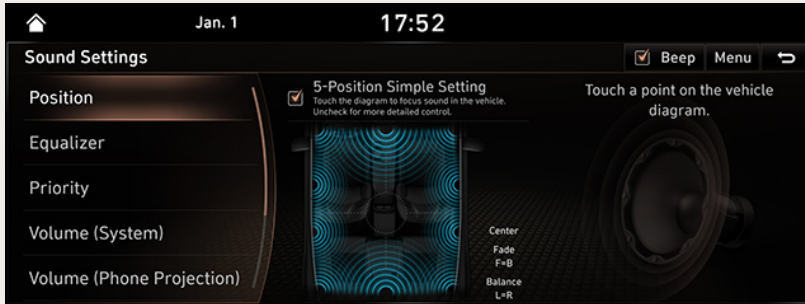

POSITION

This menu is used to set the sound position. For example, you can set the sound close to the driver-seat so that the volume is relatively lower in the passenger or rear seats.

1. Press [HOME] or  > [Setup] > [Sound] > [Position].

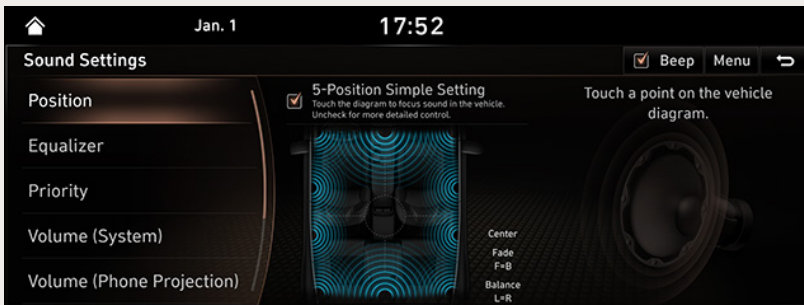

- [5-Position Simple Setting]: Touch the diagram to focus sound in the vehicle. Uncheck for more detailed control.
2. Adjust the sound position.



! NOTE

Press [**+**] to reset sound to the center position after unchecking [5-Position Simple Setting].

EQUALIZER

This menu is used to set the Treble/Midrange/Bass.

1. Press [HOME] or [**⏠**] > [Setup] > [Sound] > [Equalizer].

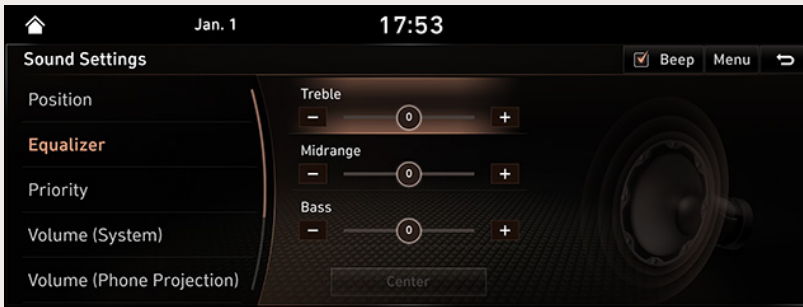

2. Adjust the Treble/Midrange/Bass.

! NOTE

Press [Center] to reset the [Treble/Midrange/Bass] settings.



PRIORITY

This menu is used to set the volume ratio.

1. Press [HOME] or > [Setup] > [Sound] > [Priority].



2. Select the desired item.

- [Navigation Guidance]: Lowers all other audio volumes when Navigation prompts are playing.
- [Proximity Warning]: Lowers all other audio volumes when the vehicle shifts into reverse.
- [Navigation During Calls]: Plays audio Navigation guidance during phone calls.
- [Start-up Max. Vol. Limit]: Lowers Radio and Media volumes if they are higher than factory set maximum start-up levels.

VOLUME (SYSTEM)

This menu is used to set the volume for each mode.

1. Press [HOME] or > [Setup] > [Sound] > [Volume (System)].

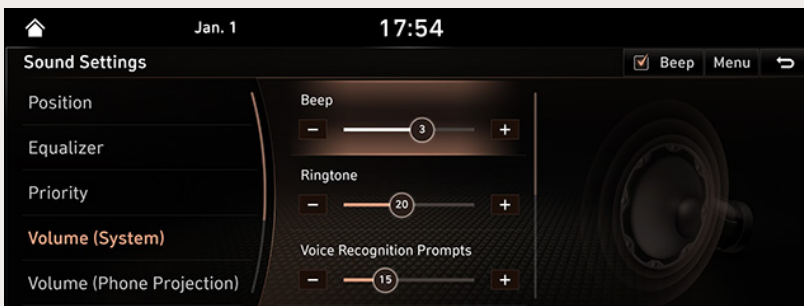

2. Adjust the volume of the [Beep], [Ringtone], [Voice Recognition Prompts], [Voice Prompts] and [Navigation Guidance].



VOLUME (PHONE PROJECTION)

This menu is used to set the volume for [Android Auto] and [Apple CarPlay] mode.

1. Press [HOME] or  > [Setup] > [Sound] > [Volume (Phone Projection)].



2. Adjust the volume of the [Android Auto] and [Apple CarPlay].
 - [Android Auto]: Sets the media and guidance volume when using the Android Auto function.
 - [Apple CarPlay]: Sets the media, phone, navigation, voice, ringtone volume when using the Apple CarPlay function.

NOTE

Press [Default] to reset the [Android Auto] and [Apple CarPlay] settings.



NAVIGATION VOLUME

This menu is used to set the navigation volume.

1. Press [HOME] or > [Setup] > [Sound] > [Navigation Volume].



2. Select the desired item.
 - [Use Map Screen Volume Buttons]: Adjusts the volume using the volume buttons on the map screen.
 - [Use Map Screen Volume Buttons or Volume Knob]: Adjusts the volume by using the volume buttons on the map screen or by turning the volume knob when the navigation guidance is playing.

SPEED DEPENDENT VOL.

This menu is used to automatically control the audio volume according to the speed of the vehicle.

1. Press [HOME] or > [Setup] > [Sound] > [Speed Dependent Vol.].



2. Select [Largest Change], [Moderate Change], [Smallest Change] or [Off].



LIVE DYNAMIC (OPTION)

1. Press [HOME] or > [Setup] > [Sound] > [Live dynamic].

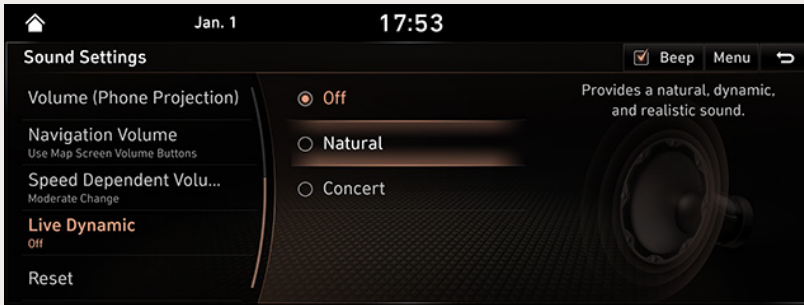

2. Select the desired item.
 - [Off]: Turns off the [Live dynamic] function.
 - [Natural]: Provides a natural, dynamic, and realistic sound.
 - [Concert]: Provides vivid sound that you would hear in a concert hall.

QUANTUM LOGIC SURROUND (OPTION)

This menu is used to set to the stereo sound improving space and depth.

1. Press [HOME] or > [Setup] > [Sound] > [Quantum Logic Surround].



2. Select the desired item.
 - [Off]: Turns off the [Quantum Logic Surround] function.
 - [Audience]: Provides an intimate concert experience where the boundaries of the vehicle seemingly disappear.
 - [On stage]: A surround-sound experience that puts listeners onstage with their favorite artists, placing individual instruments and musical elements throughout the cabin.



CLARI-FI (OPTION)

This menu is used to improve the lexicon's patented sound enhancement algorithm for all compressed audio sources.

Press [HOME] or > [Setup] > [Sound] > [Clari-Fi].



VIP SOUND (OPTION)

This menu is used to set the optimised sound for the right rear seat.

Press [HOME] or > [Setup] > [Sound] > [VIP sound].

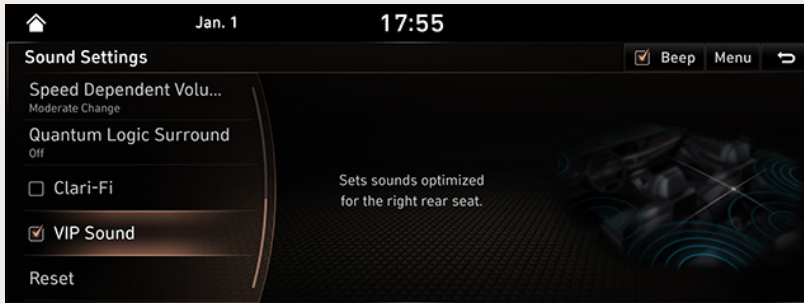



RESET

This menu is used to reset all [Sound] settings.

1. Press [HOME] or  > [Setup] > [Sound] > [Reset].

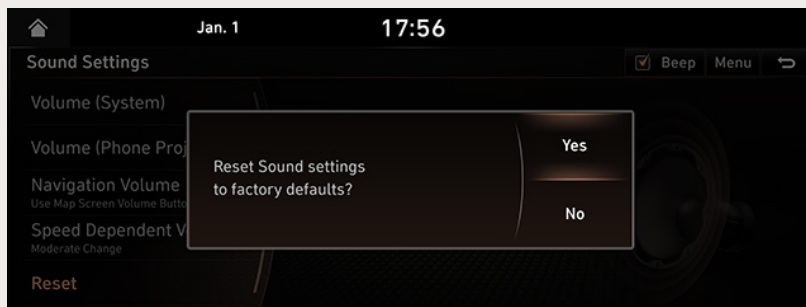

2. Press [Yes].

DISPLAY

This menu is used to control the display brightness and image rate for the whole system.

DISPLAY OFF

This menu is used to turn the screen off.

1. Press [HOME] or  > [Setup] > [Display].



2. Press [Display Off].
3. Press the screen itself again to turn the screen on.

ILLUMINATION

This menu is used to set the illumination.

1. Press [HOME] or  > [Setup] > [Display] > [Illumination (Front Seat)] or [Illumination (Rear Seat)].



2. Adjust the screen brightness.
 - [Link to Cluster Illumination Control]: Check the box to connect the display to the cluster's illumination control button.
 - [Daylight]: Adjusts the daylight illumination.
 - [Night]: Adjusts the Night illumination.
 - Press [Default] to reset the screen brightness.



MODE

This menu is used to set the display brightness according to mode changes.

1. Press [HOME] or  > [Setup] > [Display] > [Mode].

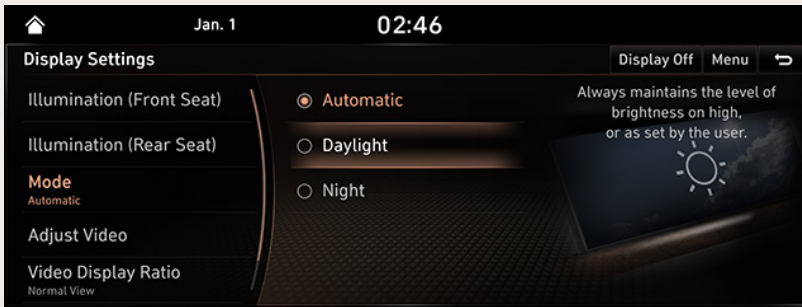

2. Select the desired options.
 - [Automatic]: Adjusts the brightness automatically according to surrounding brightness.
 - [Daylight]: Always maintains the brightness on high regardless of surrounding brightness.
 - [Night]: Always maintains the brightness on low regardless of surrounding brightness.

ADJUST VIDEO

This menu can be set during video playback.

1. Press [HOME] or  > [Setup] > [Display] > [Adjust Video].



2. Select the desired options.
 - [Brightness]: Adjusts the brightness.
 - [Contrast]: Adjusts the contrast.
 - [Saturation]: Adjusts the saturation.

NOTE

Press [Center] to reset [Adjust Video] settings.



VIDEO DISPLAY RATIO

1. Press [HOME] or > [Setup] > [Display] > [Video Display Ratio].

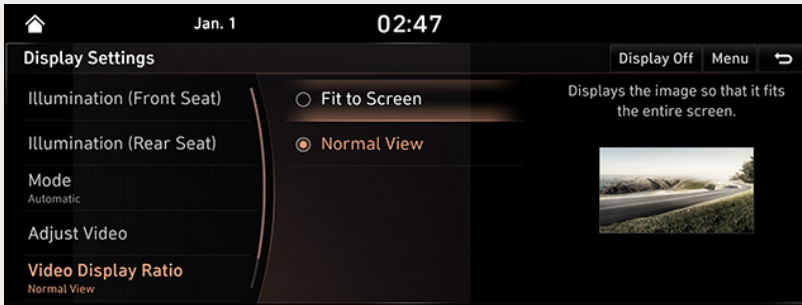

2. Select the desired option.
 - [Fit to Screen]: Displays the full screen.
 - [Normal View]: Displays the 4:3 screen with the black bar appeared at the left and right side.

RESET

This menu is used to reset all [Display] settings.

1. Press [HOME] or > [Setup] > [Display] > [Reset].

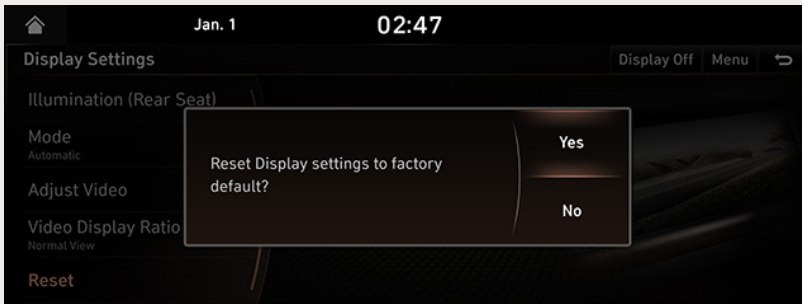

2. Press [Yes].



VOICE RECOGNITION

This menu describes voice recognition settings.

1. Press [HOME] or > [Setup] > [Voice Recognition].

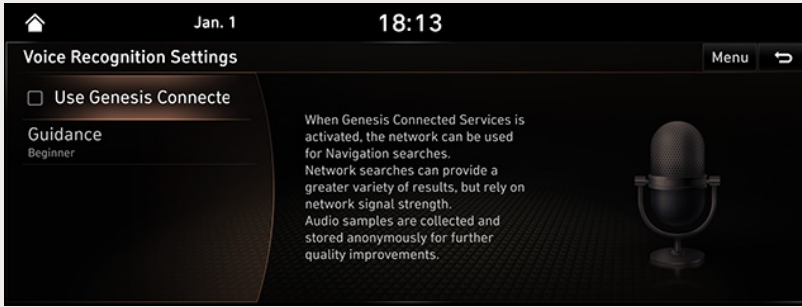

2. Select the desired item.

- [Use Genesis Connected Services Network]: When Genesis Connected Services is activated, the network can be used for Navigation searches, Network searches can provide a greater variety of results, but rely on network signal strength. Audio samples are collected and stored anonymously for further quality improvements.
- [Guidance] > [Beginner]: Voice Recognition guidance will provide detailed prompts.
- [Guidance] > [Normal]: Voice Recognition guidance will provide brief prompts.
- [Guidance] > [Expert]: Voice Recognition guidance will not provide any prompts. Only a beep will be played.



SYSTEM INFORMATION CHECK AND UPDATE GUIDE

SOFTWARE INFORMATION

This menu is used to view the system information.

Press [HOME] or > [Web manual] > [Software Information]. Or Press [HOME] or > [Setup] > [System Info] > [Software Information].



NOTE

The system information may differ from the actual information of the vehicle.



UPDATE

For system's software security, new function addition, and map update, you need an update.

1. Press [HOME] or > [Web manual] > [Software Information]. Or Press [HOME] or > [Setup] > [System Info] > [Software Information].



2. After inserting the USB with the update file, press [Update].
Once updating is complete, the system will automatically restart.

NOTE

- This product requires regular updates for software corrections, new functions and map updates. Updating may require up to 1 hour depending on the data size.
- Turning off the power or ejecting the USB during the update process may result in data loss.

STORAGE

This menu is used to display the capacity of the stored information on the voice memo.

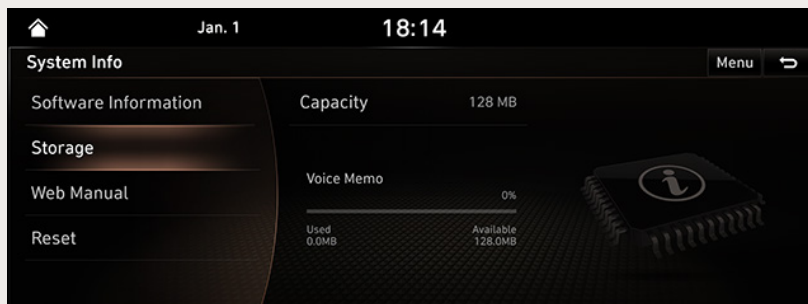

Press [HOME] or > [Web manual] > [Storage]. Or Press [HOME] or > [Setup] > [System Info] > [Storage].





WEB MANUAL

This menu is used to view the Web Manual.



1. Press [HOME] or  > [Web manual]. Or Press [HOME] or  > [Setup] > [System Info] > [Web manual].



2. Scan the QR code of your mobile device. Keep display bright and avoid glare to scan correctly.

RESET

This menu is used to reset all settings specified by the user.

1. Press [HOME] or  > [Web manual] > [Reset]. Or Press [HOME] or  > [Setup] > [System Info] > [Reset].



2. Press [Yes].

OTHERS





ABOUT PHONE PROJECTION

WHAT IS ANDROID AUTO/APPLE CARPLAY?

Securely access your smartphone while driving. Various functions of your smartphone are displayed on and operable from the screen of the media device (e.g. navigation, making a call, listening to music etc.)

When connected, an Android Auto/Apple CarPlay icon appears on the screen. Available functions and operations may differ depending on the company model.

For more information, visit the Google or Apple website.

- Google: <http://support.google.com/androidauto/>
- Apple: <http://www.apple.com/ios/carplay/>

Cautions

- Android Auto is a registered trademark of Google Inc.
- Apple CarPlay is a registered trademark of Apple Inc.
- Android Auto and Apple CarPlay are unavailable if the phone OS is not the latest version or if the phone cannot be recognized due to a shutdown caused by a failure or defect in the device itself.
- Your phone may not be recognised if its battery is low. Charge your phone then try again.
- If your phone is shut down due to a defect in the device itself, reset your phone and try again.
- If the USB cable of the Android Auto/ Apple CarPlay device is repeatedly disconnected and reconnected in a short period of time, the phone may malfunction. This can also cause a device failure.
- The device recognition time may differ depending on the device type and firmware/OS version.
- Using the USB cable that came with the phone is recommended. (Using a non-genuine product may cause noise or malfunction.)
- Normal operations cannot be guaranteed if the phone is arbitrarily manipulated while Android Auto/Apple CarPlay is active.
- Apple CarPlay cannot be run while making a call via Bluetooth.
- Android Auto or Apple CarPlay may not operate normally due to mobile phone issues.
- Carrier charges may apply when using Android Auto or Apple CarPlay.
- Some features may not operate normally according to the version of iOS and Android.



- The following problems may occur due to phone-related issues:

[Android Auto]

- Intermittent black screens appear when entering Android Auto.
- Differentiation of phones that support Android Auto and those which do not, may not be possible.
- Black screens appear in some areas of the screen due to app errors.

[Apple CarPlay]

- Intermittent black screens appear when entering Apple CarPlay.
- Black screens appear in some areas of the screen due to app errors when navigating between screens in Apple CarPlay.
- Audio volume cannot be adjusted depending on the status of a connected mobile phone.
- The sound output of a call may be cut upon disconnecting Apple CarPlay during a call via Apple CarPlay.
- If services do not work properly due to problems similar to the specified above, check your phone, and if necessary, reconnect your phone after restarting.



USING ANDROID AUTO OR APPLE CARPLAY

1. Make sure only genuine USB cables are used that were provided by the mobile phone's manufacturer.
2. Enter [Android Auto] or [Apple CarPlay] from the [HOME] screen.
3. Now the features such as navigation, music and phone are ready to be used.

NOTICE

- Before connecting your mobile phone, check whether Android Auto or Apple CarPlay is activated in the [Phone Projection] menu.
- After connecting the mobile phone, the phone has to be unlocked and the disclaimers on the phone have to be accepted in order to launch Android Auto or Apple CarPlay.
- The screens and features displayed on the infotainment system correspond to the screens and features provided by Google or Apple. They are subject to changes according to the policy of the respective company.

NOTICE-Android Auto

- Bluetooth media features will be disabled when Android Auto is activated. After removing the USB cable, these features will be available again.
- If Android Auto is not activated even after a successful connection, follow these steps:
 - Check whether an error occurred on the phone.
 - Check whether Android Auto has been closed on the phone.
 - Check whether Android Auto is activated in the [Phone Projection] menu.
- If Android Auto does not work normally even after a reconnection has been made, visit the Google website <http://support.google.com/androidauto>.
- Please refer to the following websites to check the available countries for the [Android Auto]. <https://www.android.com/auto>

NOTICE-Apple CarPlay

- Bluetooth phone/media features will be disabled when Apple CarPlay is activated. After removing the USB cable, these features will be available again.
- If Apple CarPlay is not activated even after a successful connection, follow these steps:
 - Check whether Apple CarPlay is disabled in the iPhone's application settings.
 - Check whether Apple CarPlay is activated in the [Phone Projection] menu.
- If Apple CarPlay does not work normally even after a reconnection has been made, visit the Apple website <http://www.apple.com/ios/carplay/>
- Please refer to the following websites to check the available countries for the [Apple CarPlay]. <http://www.apple.com/ios/feature-availability/>



VOICE MEMO

MAKING A VOICE MEMO

You can record your voice.

Press [HOME] or [] > [Voice Memo].

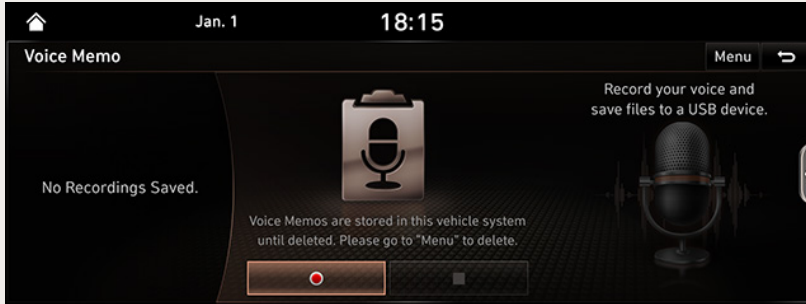

START

Press [] on screen. Record your voice.

PAUSE

Press [] on screen.

STOP

Press [] on screen during recording. The recorded file is saved to the voice memo list.

NOTE

- Navigation guidance will be muted while recording.
- The latest recorded file is placed on the top of voice memo list.
- When the storage space is full while recording, the voice memo ends after saved.



PLAYING A VOICE MEMO

You can play your recorded voice.

1. Press [HOME] or > [Voice Memo].
2. Press the recorded file from voice memo list.

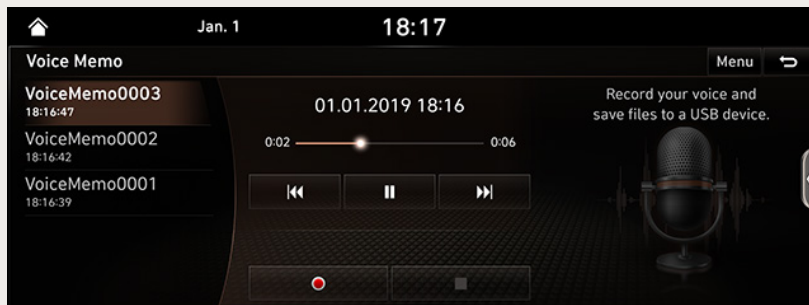

PAUSE

Press [||] on screen.

Press [▶] on screen to play it again.

SKIP

You can play the previous or next file.

Position	Description
Screen	Press [◀◀/▶▶].
Rear Seat control key	Press [< SEEK >].

SEARCH

You can rewind/fast forward to a specific point of a file.

Position	Description
Screen	Press and hold [◀◀/▶▶] and then release at the point you want.
Rear Seat control key	Press and hold [< SEEK >] and then release at the point you want.



SAVING THE VOICE MEMO TO USB DEVICE

1. Connect an USB device to the USB port.
2. Press [Menu] > [Save to USB Device] on the voice memo screen.



3. Select the voice memo to save and press [Save] > [Yes].
 - [Mark All]: Marks all items.
 - [Unmark All]: Unmarks all items.
 - [Cancel]: Exits save screen.

STORAGE INFORMATION

This menu is used to display the capacity of the stored information on the voice memo. Press [Menu] > [Storage Info] on the voice memo screen.





DELETING VOICE MEMO

1. Press [Menu] > [Delete] on the voice memo screen.

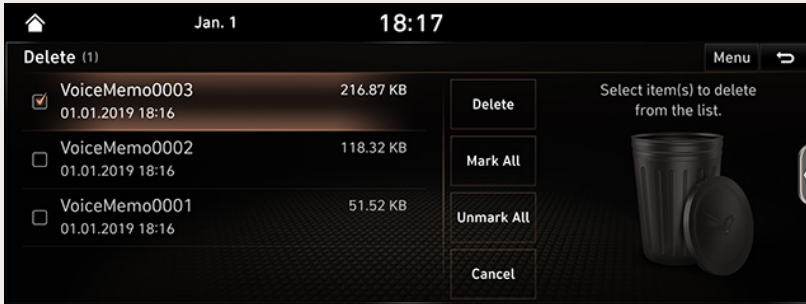

2. Select the voice memo to delete and press [Delete] > [Yes].

- [Mark All]: Marks all items.
- [Unmark All]: Unmarks all items.
- [Cancel]: Exits delete screen.



VOICE RECOGNITION SYSTEM

WHAT IS VOICE RECOGNITION?

Voice recognition technology runs the system as ordered by recognizing your voice command to help with the operation of media while you are driving the car. Regrettably, not all possible voice commands are recognized by the system due to technological limitations. To make up for these limitations, the system displays the voice commands that are available for you to use.

There are errors in communication between people. Likewise, voice recognition sometimes misunderstands your voice command under certain circumstances. If this happens, either check the screen for the available options and say the command again, or manually select and press the button for the corresponding command on the screen.

VOICE RECOGNITION FEATURES BY LANGUAGE

Voice recognition support availability varies according to the language set for the system. Please verify the current language setting before using the voice recognition.

- If you change the language set for the system to Korean, voice recognition will not be supported. Change the system language to other language.

OPERATING VOICE COMMAND

CONDITION FOR VOICE COMMAND SYSTEM

Most of the functions can be operated by voice. Please follow the instructions below for optimal voice recognition performance.

- To improve the voice recognition performance, keep your car interior quiet by closing all windows and the sunroof.
- Press the voice recognition button and say the desired voice command after the beep sound.
- The microphone is positioned above the driver. Voice commands should be spoken by driver practicing proper posture.
- Pronounce the voice commands naturally and clearly as if in a normal conversation.
- Special symbols of Phonebook Name are not considered in voice recognition. Ex) James-Smith : "James Smith"
- House number or digits in Phonebook Name should be spoken discretely. Ex) S1234 : "South one two three four"
- Depending on the specifications, some commands may not be supported.



STARTING VOICE RECOGNITION

1. Press [] on the steering wheel remote control.
2. Say the desired voice command after the beep sound.

NOTE

- For proper recognition, please say the command after the voice instruction and beep sound.
- When starting voice recognition, the voice command entry window with 4 representative commands is displayed.
- If voice recognition is in [Beginner], then the system will provide the detailed voice recognition guidance. If voice recognition is in [Normal], then the system will provide the simple version of voice recognition guidance. If voice recognition is in [Expert], then the system will not provide any prompts. Only a beep will be played.

SKIPPING PROMPT MESSAGES

While a prompt is playing, press quickly on the steering wheel remote control labeled with []. The prompt is immediately ended and a beep will sound. After the beep, please say the voice command.

RE-STARTING VOICE RECOGNITION

While the system waits for input, press quickly on the steering wheel remote control labeled with []. The beep tone will sound, indicating the system is listening for a new input. Say a voice command.

ENDING VOICE RECOGNITION

- While voice recognition is operating, press and hold the control labeled [] on the steering wheel remote control, or say 'Exit'.
- While using voice recognition, pressing other button except on the steering wheel remote control or a different button on head unit will end voice recognition.

ADJUSTING VOICE RECOGNITION VOLUME

While voice recognition is operating, turn [VOL] knob on the head unit or press [+/-] on the steering wheel remote control.



BASIC OPERATION FOR VOICE COMMAND (SETTING FM)

1. Press the control on the steering wheel remote control labeled [📞]. The system waits for your command and displays a list of available commands on the screen.



2. If you hear a beep sound after voice guidance, say "FM".

VOICE RECOGNITION QUICK START (MANUAL CONTROL)

The usual way of activating voice recognition is waiting for the voice guide and then speaking your command for a task. Since this method requires that you wait a while for the voice guide, you can select one of the commands shown on the screen to speed up the process.

You might find this feature useful when you do not want to wait for the full voice guide or when the system does not recognize your voice.

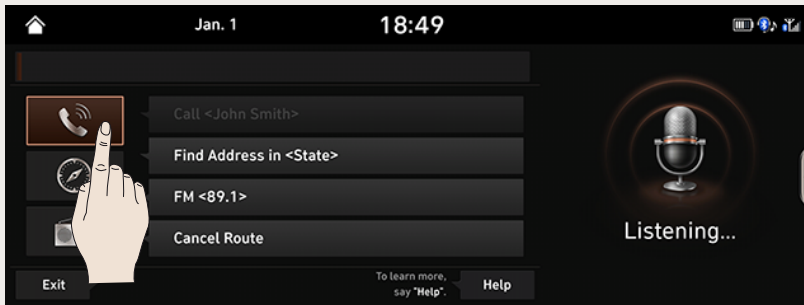



ABOUT VOICE COMMAND “HELP”

1. Press the [V] on the steering wheel remote control.
2. If you hear a beep sound after voice guidance, say “Help”. The available commands are displayed on the screen.



3. Select or say the displayed command on the screen.



VOICE COMMAND LIST

Voice recognition commands are classified as “Global Commands” and “Local Commands”.

- Global commands (●) : Commands that can be used immediately after activating voice recognition.
- Local commands (□) : Commands that can be used in specific media/navigation/Bluetooth mode states.

! NOTE

Some global and local commands will operate properly only when a USB, iPod, Bluetooth or other device has been connected.

PHONE COMMANDS

- Voice commands related to phone calls can be used after connecting the Bluetooth phone device.
- To call a person, for example “Call <John Smith>” whose name is listed in contacts, you must first download the mobile phone contacts. (Up to 5,000 mobile phone contacts can be downloaded.)
- After downloading the Bluetooth phone contacts, it will take some time to convert the phone contacts into voice data during which time you cannot make a call by name yet. The time that it taken to convert voice data may vary depending on the number of contacts downloaded.

Command		Operation
●	Call	Downloaded mobile phone contacts is displayed on the screen, and afterwards, you can make a call by speaking the name.
●	Call <Name>	You can immediately make a call to (name) in the downloaded mobile phone contacts. Ex.) “Call John Smith”
●	Call <Name> on Mobile	You can immediately make a call to (name) in the downloaded mobile phone contacts saved as ‘mobile’. Ex.) “Call John Smith on mobile”
●	Call <Name> at Work	You can immediately make a call to (name) in the downloaded mobile phone contacts saved as ‘office’. Ex.) “Call John Smith at work”
●	Call <Name> at Home	You can immediately make a call to (name) in the downloaded mobile phone contacts saved as ‘home’. Ex.) “Call John Smith at home”



●	Call <Name> on Other	You can immediately make a call to (name) in the downloaded mobile phone contacts saved as another phone category except 'mobile, home, office'. Ex.) "Call John Smith on other"
●	Dial number	Displays a screen where you can say a phone number to dial.
●	Dial <Phone #>	You can make a call by directly speaking the number you want to call. Ex.) Dial 123-456-7890 : "Dial one two three four five six seven eight nine zero"
●	Change Bluetooth Device	It can disconnect from the Bluetooth device currently connected and connect to other Bluetooth devices already paired.



RADIO COMMANDS

Command		Operation
●	Radio	It runs radio that listened recently between FM, AM and SiriusXM™.
●	FM	It runs FM radio.
●	AM	It runs AM radio.
●	SiriusXM™	It runs SiriusXM™ radio.



NAVIGATION COMMANDS

Check the following before you use navigation commands :

1. Search for and find addresses located in the state or province your car is currently in. If you want to search in another state, say the name of state/province and then say the address. "Find Address" command is classified by states/provinces to provide you with faster service.
2. Some commands such as "Cancel Route" are available only when the destination is fixed.

Command		Operation
●	Find Address in <State>	Finds the address in <State> and sets it as the destination. Ex.) Find Address in California To find an address, you should say "House Number → Street → City" (in order, excluding the state). Ex.) 300 (Three Zero Zero), Main Street, Almond
●	Find <POI Category>	Immediately finds <Category> of POI nearest to your current location. Ex.) Find "Parking"
●	Cancel Route	Cancels the route to the fixed destination and exits guidance.
●	Destination Information	Tells you the remaining distance and time to your destination.
●	Previous Points	Displays a list combining Previous Destinations, and Previous Starting Points all together. You can set a destination by saying the list number.
●	Previous Destinations	Displays a list of recent destinations and you can set a destination by saying the number on the list.
●	Previous Starting Points	Displays a list of recent starting points and you can set a destination by saying the number on the list.
●	Traffic Information	Moves to the Traffic Information menu screen.
●	Go Home	Set your home as the destination. Your home address must be set up in the Navigation System.
●	Change Home	Changes location for Home.
●	Go to Work	Set the destination to your office/place of work. Your office/place of work must be set up in the Navigation System.
●	Change Work	Changes location for Work.
●	Route Options	Restarts the route to your destination. You can select either "Faster Time" or "Shorter Distance".
●	Show Route	Displays a map overview of the entire route to your destination.
●	Zoom Out	Zooms out from the navigation map to the fullest.



●	Zoom In	Zooms in on the navigation map to the fullest.
●	Frequently Visiting Points	Displays a list of frequently visiting points.
●	Turn Guidance On	Turns on the voice guidance system.
●	Turn Guidance Off	Turns off the voice guidance system.
●	Address Book	Displays a list of the address book. You can set a destination by saying number on the list.



OTHER COMMANDS (COMMANDS USED IN LIST / HELP/ ETC.)

Command		Operation
<input checked="" type="checkbox"/>	Help	Goes to the voice recognition help screen. All available commands can then be identified and used.
<input type="checkbox"/>	Yes/No	When voice recognition is active, this command is used when an answer is requested for a confirmation question.
<input type="checkbox"/>	Line 1-4 (One-Four)	When you cannot select a certain name, such as in Call History, you can select it using line number. Simple numbers, such as “one” and “two”, can be recognized.
<input type="checkbox"/>	Next/Previous	When five or more searched items are listed, you can move to the previous or next page using a voice command.
<input type="checkbox"/>	Manual Input	When Dial or Destination search results are displayed, this command is used to search manually rather than searching using a voice command. Voice recognition stops after this command is used.
<input type="checkbox"/>	Go Back	Goes back to the previous screen.
<input checked="" type="checkbox"/>	Exit	Ends the voice recognition.



LIST OF NEAREST LOCATIONS

Navigation location names may be changed after a software update.

Restaurants		
Fast Food Restaurants	Coffee Shops	Olive Garden
Arby's	Starbucks	Papa John's
Boston Market	Dunkin' Donuts	Papa Murphy's
BURGER KING	Tim Hortons	Pizza 73
Carl's Jr	American Restaurants	Pizza Hut
Chick-fil-A	Applebee's	pizza pizza
Chipotle	Bahama Breeze	Cici's Pizza
Church's Chicken	Boston's Restaurant & Sports Bar	Godfather's
Dairy Queen	Cheeseburger in Paradise	Hungry Howie's Pizza
Firehouse Subs	Chili's Grill	Marco's Pizza
Fleming's	Cool River	Latin American Restaurants
Hardee's	Denny's	Mexican Restaurants
IHOP	Frisch's Big Boy	Cantina Laredo
In-N-Out Burger	Good Eats	Chevys
Jack in the Box	Ill Forks	El Chico
Jimmy John's	Lee Roy Selmon's	Del Taco
KFC	Lone Star Steakhouse & Saloon	Moe's Southwest Grill
Little Caesars	Longhorn Steakhouse	Qdoba
Long John Silver's	Luckys Cafe	Asian Restaurants
McAlister's Deli	Outback Steakhouse	Chinese Restaurants
McDonald's	Ponderosa	PF Chang's China Bistro
Panda Express	Publix	Japanese Restaurants
Panera Bread	Seasons 52	Korean Restaurants
Popeyes	Sheetz	Seafood Restaurants
Quiznos Sub	Silver Fox	Red Lobster
Schlotzsky's	Texas Roadhouse	Captain D's
SONIC	TGI Friday's	Vegetarian Restaurants



SUBWAY	The Capital Grille	French Restaurants
Taco Bell	A&W	Continental Restaurants
Taco John's	Bob Evans	African Restaurants
Waffle House	Buffalo Wild Wings	Other Restaurants
Wendy's	Cracker Barrel Old Country Store	Auntie Anne's
White Castle		Baskin-Robbins
Blimpie	Golden Corral	Haagen-Dazs
Checkers	Red Robin	Hooters
Culver's	Ruby Tuesday	Roy's
Five Guys Burgers and Fries	Wingstop	TCBY
Jamba Juice	Italian Restaurants	VAN DER VALK
Jersey Mike's Subs	Bonefish Grill	Bojangles'
Smoothie King	Carrabba's Italian Grill	Cold Stone Creamery
Steak n Shake	Chuck E Cheese's	Zaxby's
Whataburger	Domino's	



Automotive		
Hyundai Dealerships	Speedway	ACDelco
Genesis Dealerships	Sunoco	Hydrogen Stations
Gas Stations	Sunoco Canada	Big O Tires
76	TEXACO	CARQUEST
ampm	TravelCenters of America	Meineke Car Care Center
ARCO	Ultramar	Monro Muffler Brake & Service
BP	Valero	Napa Autocare Center
Gas+	Wawa	Pep Boys
Casey's General Store	Hess Express	Quick Lane
Cenex	Irving	Safelite AutoGlass
Chevron	Parking	Tires Plus
CITGO	Auto Services	Valvoline Instant Oil Change
Conoco	AAA	Roadside Assistance
Esso	Advance Auto Parts	Auto Parts
Exxon	America's Tire	Car Washes
Fleetfuels	AutoZone	Automobile Dealerships
GetGo	BOSCH Car Service	Motorcycle Dealerships
Giant Gasoline	O'Reilly Auto Parts	Electric Charging Stations
GTO	Certigard	Aloha
Gulf	Chevron	Chevron
Husky	CITGO	CITGO
Ingles Gas Express	Discount Tire	Costco
Marathon	Exxon	Exxon
Martin's Gasoline	Firestone	Flying J
Meijer	GOODYEAR	Fred Meyer Fuel Center
Mobil	Gulf	Fry's Fuel Center



Murphy Express	Jiffy Lube	Fry's Marketplace Fuel Center
Murphy USA	Kal Tire	Kroger Fuel Center
Petro Stopping Centers	Midas	Kum & Go
PETRO-CANADA	Mobil	Kwik Trip
Phillips 66	Napa	Meijer Gas Station
Pioneer		Murphy Express
QuikTrip	PETRO-CANADA	NISSAN
Rutter's	Sears Auto Center	QuikTrip
Sheetz	Shell	Shell
Shell	TEXACO	TEXACO
Sinclair	AAMCO Transmissions	Valero



Travel		
Airports	Homewood Suites	Staybridge Suites
Hotels	Hotel Indigo	Studio 6
Americas Best Value Inn	Howard Johnson	Suburban Extended Stay
AmericInn	Hyatt Place	Super 8
Andaz	Hyatt	Thriftlodge Canada
Ascend Collection	Hyatt Summerfield Suites	Travelodge
Baymont Inn & Suites	Intercontinental	Travelodge Canada
Best Western	JW Marriott	VAN DER VALK
Cambria Suites	La Quinta Inn & Suites	WALDORF ASTORIA COLLECTION
Canadas Best Value Inn	Lexington	Wingate by Wyndham
Candlewood Suites	Mainstay Suites	Wyndham
Clarion Hotel	Marriott	Extended StayAmerica
Comfort INN	Marriott VACATION CLUB	Fairfield Inn by Marriott
Comfort Suites	Microtel Inns & Suites	Rental Car Agencies
CONRAD	Motel 6	Alamo
Country Inn & Suites by Carlson	NOVOTEL	AVIS
COURTYARD by Marriott	Omni Hotels	Budget
Crowne Plaza	Park Inn	Dollar Rent A Car
Days Inn	Park Plaza	Enterprise
DELTA	QUALITY INN	Hertz
Doubletree	Radisson	National
Econo Lodge	Radisson SAS	Thrifty
Embassy Suites	RAMADA	Tourist Information
Grand Residences by Marriott	Red Roof Inn	Tourist Attractions
Hampton Inn	Regent Hotels & Resorts	Travel Agents
	Renaissance	Rest Areas
Hawthorn Suites	Residence Inn	City Centers
Hilton	Ritz-Carlton	Campgrounds



Hilton Garden Inn	Rodeway Inn	Ferry Terminals
Hilton Grand Vacations	Sheraton	Bus Stations
Holiday Inn	Sleep Inn	Local Transit
Holiday Inn Express Hotel & Suites	SOFITEL	Train Stations



Shopping		
Department Stores	Meijer	Bath & Body Works
Canadian Tire	Publix	BED BATH & BEYOND
Dollar General	Sav-Mor Foods	Carpet One
Dollar Tree	Save-A-Lot	Do It Best
Family Dollar	SuperValu	Family Video
JCPenney	Albertsons	GNC
Kmart	ALDI	HOBBY LOBBY
Kohl's	Piggly Wiggly	Home Hardware
Nordstrom	Safeway	Jo-Ann
Sears	Winn-Dixie	Michaels
Sears Hometown Store	Pharmacies	Party City
Target	CVS/pharmacy	Pier 1 Imports
T.J. Maxx	Giant Drugstore	Sam's Club
Walmart	Giant Eagle	SEPHORA
Big Lots	Ingles Pharmacy	Sleepy's
Macy's	Kmart Pharmacy	Sunglass Hut
Marshalls	Kroger Pharmacy	Toys"R"Us
Ross Dress For Less	Martin's Drugstore	Tuesday Morning
Convenience Stores	Meijer Pharmacy	Sporting Goods Stores
7-Eleven	Publix	Dick's Sporting Goods
ampm	Rite Aid	Sports Authority
BP	Shoppers Drug Mart	HIBBETT SPORTS
Circle K		Music Stores
Fleetfuels	Walgreens	Bookstores
GetGo	Medicine Shoppe	Barnes & Noble Booksellers
GTO	Safeway	Gift Shops
Kangaroo Express	Sam's Club	Clothing Shops
Murphy Express	Electronics Stores	Mark's



Murphy USA	AT&T	Payless Shoesource
Petro Stopping Centers	Best Buy	Aeropostale
QuikTrip		American Eagle Outfitters
Rutter's	GameStop	Cato
Sunoco Canada	Radioshack	Chico's
TravelCenters of America	Sprint	Children's Place
Wawa	Staples	Dressbarn
Cumberland Farms	T-Mobile	Famous Footwear
Hess Express	OfficeMax	Finish Line
Mac's	US Cellular	Foot Locker
Mini Mart	Verizon	GAP
Quick Stop	Boost Mobile	Gymboree
Valero Corner Store	Cricket Wireless	Hot Topic
Shopping Centers	metroPCS	Journeys
	Home Specialty Stores	Justice
	ABC Fine Wine & Spirits	Lane Bryant
	Ace Hardware	Men's Wearhouse
US Bank	Claire's	Old Navy
Grocery Stores	Costco	PacSun
Giant Eagle	Home Depot	Rainbowshops
Giant Food Stores	Lowe's	rue21
IGA	Merle Norman	Victoria's Secret
Ingles Markets	PETCO	Shoe Stores
Food Lion	PETSMART	Payless Shoesource
Kmart	Sally Beauty Supply	General Merchandise
Kroger	SHERWIN-WILLIAMS	
Martin's Food Markets	True Value	



Recreation		
Amusement Parks	Sports Complexes	Ski Resorts
Museums	Sports Activities	Recreation Areas
Cinemas	Wineries	Other Recreation Areas
Golf Courses	Video & Game Rental	

Financial Services		
Banks	Capital One	TD Bank
Bank of America	CIBC	TD Canada Trust
BB&T	First Citizens Bank	US Bank
Chase	First National Bank	Wells Fargo
Citibank	M&T Bank	Bank of the West
Citizens Bank	Santander	BMO Bank of Montreal
Fifth Third Bank	Scotiabank	BMO Harris Bank
KeyBank	The Huntington National Bank	Caisse Populaire Desjardins
PNC Bank	Woodforest National Bank	Capital One
RBC Royal Bank	ATMs	CIBC
Regions	Bank of America	Commerce Bank
SunTrust	BB&T	First National Bank
TD Bank	Chase	HSBC
TD Canada Trust	Citibank	M&T Bank
US Bank	Citizens Bank	Santander
Wells Fargo	Fifth Third Bank	Scotiabank
Bank of the West	KeyBank	State Employees' Credit Union
BBVA Compass	PNC Bank	Check Cashing Services
BMO Bank of Montreal	RBC Royal Bank	Money Transfer
BMO Harris Bank	Regions	
Caisse Populaire Desjardins	SunTrust	



Community		
Police Stations	Convention Centers	Court Houses
Post Offices	Churches	Government Offices
Libraries	Synagogues	Waste & Sanitary Services
Schools	City Halls	Utilities
Fire Departments	Civic Centers	Business Facilities
Services		
Hospitals	Cleaning & Laundry Services	Nursing Homes
Medical Services	Social Services	Optical Services
Physicians	Communication	Personal Services
Tax Services	Dentists	Repair Services
Attorneys	Photography Services	Veterinary Hospitals
Funeral Homes	Tailors & Alterations	Shipping Centers
Hair & Beauty Services	Movers	

SIRI®

ABOUT SIRI®

WHAT IS SIRI®?

Apple wants to integrate the Siri to specific voice control system by working with car manufacturers.

You can ask Siri through the [Siri] button on the steering wheel remote control while driving. The Apple device (iOS device) screen does not light up to minimize impact on the driving. If there is “Eyes-free” function, you can operate the Siri feature. (Making phone calls, Playing music, Listening to or writing a text message, Finding the destination by using the map, Looking for calendar information, etc)

USING SIRI®

STARTING SIRI®

1. Connect your Apple device (iOS device) to AVN system through Bluetooth. Please check whether your Apple device (iOS device) supports Siri and turning Siri On.
2. Press and hold [Siri] on the steering wheel remote control.

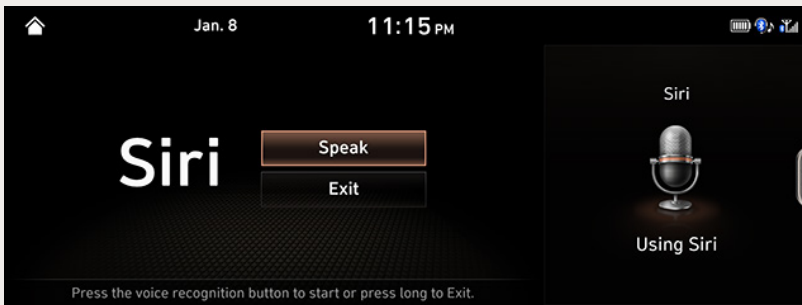

<Siri screen>

3. Say a command. For proper recognition, please say the command after the voice instruction and Siri beep tone.



RE-STARTING SIRI®

- While system waits, press [🔊] on the steering wheel remote control. The command waiting condition is ended and the beep tone will make sound. After the “beep”, say the voice command.
- Press [Speak] on the Siri screen. The command waiting condition is ended and the beep tone will make sound. After the “beep”, say the voice command.

ENDING SIRI®

- While Siri is operating, press and hold [🔊] on the steering wheel remote control or say “Exit”.
- While using voice recognition, pressing other button except on the steering wheel remote control or a different button on head unit will end Siri feature recognition.
- Press [Exit] on the Siri screen.

ADJUSTING SIRI® VOLUME

While Siri is operating, turn [VOL] knob on the head unit or press [+/-] on the steering wheel remote control.

! NOTE

- Please see the AVN system only supports “Music” and “Phone” related functions. Other functions will be performed in the your Apple device (iOS device).
- Eyes-Free mode would be activated automatically while you are driving. If the car is stopped (when the transmission lever is put to P), Eyes-Free mode would be deactivated automatically.



USING REAR CAMERA - OPTION

ABOUT REAR CAMERA

- Rear camera is an option for the customers who selected the option.
- In this instrument, for the safety of the user, a rear camera that can secure the rear view during the backward driving is connected.
- After the vehicle is started, if the transmission lever is put to R, the rear camera power is automatically turned on, and the rear camera starts operation.
- If you change the transmission lever location from R to P position, rear camera stops.

TURNING ON THE REAR CAMERA

When the vehicle is started, put the transmission lever to R position.



Adjust the desired value for brightness or contrast as appropriate.

! NOTE

Rear camera has an optical lens to secure wide view, so there is a little difference in the distance shown on the screen. For safety, make sure to check the rear, left, and right view by yourself.

BACKING UP & USING CAMERA

Never rely solely on the rear view camera when backing up. Prior to entering your vehicle always do a visual check of the area behind your vehicle, and before backing up be aware of your surroundings and supplement the rear view camera by looking over your shoulders and checking your rear view mirrors. Due to the difficulty of ensuring that the area behind you remains clear, always back up slowly and stop immediately if you even suspect that a person, and especially a child, might be behind you.



SVM (SURROUND VIEW MONITOR) - OPTION

ABOUT SVM (SURROUND VIEW MONITOR)

SVM (Surround View Monitor) is an option that is provided to the customers who selected the option.

Through the 4 cameras installed on the vehicle, it can view front, back, left and right side.

While vehicle is started, if gear is put to R position, it automatically starts SVM (Surround View Monitor).

If gear is changed from R to P position, SVM (Surround View Monitor) operation stops.

OPERATING FRONT SVM

After starting the vehicle, if you press "Camera Switch" after putting gear to N or D, front SVM starts.

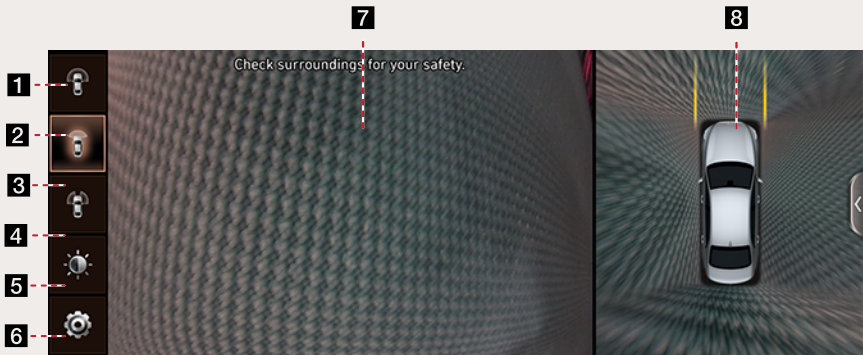

1 Front Top View (Front + Left Front + Right Front)

Displays an enlarged top view of the front.

2 Wide View (Front)

Only front screen of the vehicle is displayed.

3 Left and right side view (Left Front + Right Front)

It displays left front / right front screen of the vehicle simultaneously.

4

You can adjust Brightness / Contrast.



5 

Move to SVM Settings Menu.

6 **Front Camera View**

Front camera's view is displayed.

7 **Top View**

Displays top view that combines front, rear, left / right camera images.

 **NOTE**

While front SVM is running, if you drive at about 15 km/h or more, SVM is turned off. At this state, even if you drive at about 15 km/h or less, SVM is remained at OFF state.



OPERATING REAR SVM

After starting the vehicle, if you put gear at R position, rear SVM starts.

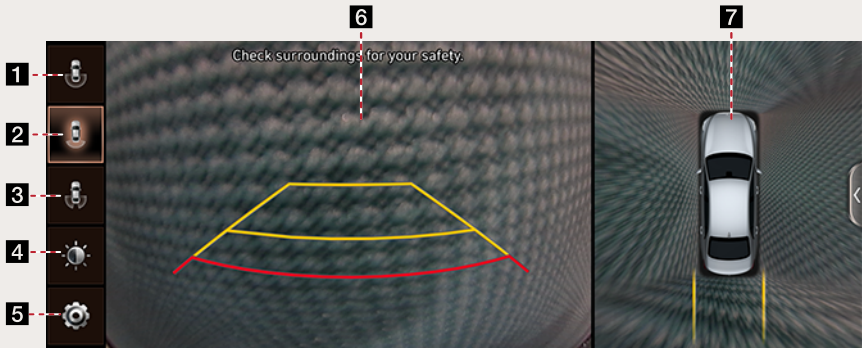

1 Rear Top View (Rear + Left Rear + Right Rear)

Displays an enlarged top view of the rear.

2 Wide View (Rear)

It displays only the rear screen of the vehicle.

3 Left and right side view (Left Front + Right Front)

It displays left rear / right rear screen of the vehicle simultaneously.

4

You can adjust Brightness / Contrast.

5

Move to SVM Settings Menu.

6 **Rear Camera Screen**

It displays rear view through the rear camera.

7 **Top View**

Displays top view that combines front, rear, left / right camera images.

NOTE

SVM (Surround View Monitor) camera has an optical lens to secure wide view, so there is a little difference in the distance shown on the screen. For safety, make sure to check the rear, left, and right view by yourself.



SVM SETTING

If you press  button, it moves to 3 types of setting screens.



- [Display Contents]: Enables / disables rear view distance guidance, top view parking guidance, rear view parking guidance, and parking distance warning function.
- [Top View Default Mode]: Sets the initial view of Top View. (Zoom-In View, Normal View, Zoom-Out View)
- [Front View Default Mode]: Sets the initial view of the front camera to the initial view. (Top View, Wide View, L/R Corner View)

WARNING DISPLAY

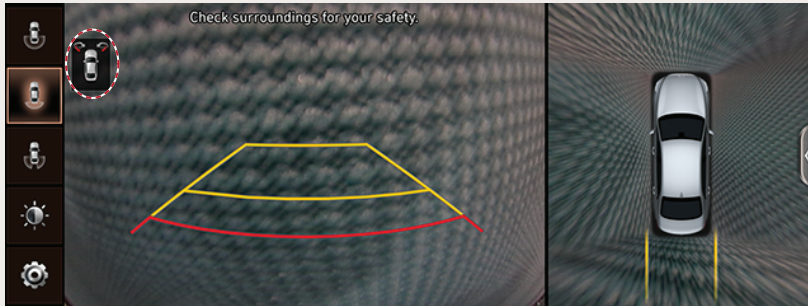

DRIVER'S DOOR OPEN INDICATOR

When the driver's door is open, "🚪" (red color on left door) indicator is displayed on the top left of the screen.

FRONT PASSENGER'S DOOR OPEN INDICATOR

When the front passenger's door is open, "🚪" (red color on right door) indicator is displayed on the top left of the screen.

TRUNK OPEN INDICATOR

When trunk is open, "🚪" (red color on trunk) indicator is displayed on the top left of the screen.

SIDE MIRROR FOLDING INDICATOR

When the side mirror is folded, "🚪" (side mirror) indicator is displayed on the top left of the screen.



DRIVING INFO

CHECKING DRIVING INFO

Available when the vehicle is started.

You can check information on Driving/Idling Times, Sudden braking/Acceleration Distributions, Driving Speed and Driving Range.

1. Select [Driving Info] on the HOME Screen.



2. Select [Menu] > [Update] to receive the updated information for driving.



CLIMATE

CLIMATE MODE

Press [HOME] or [] > [Climate].

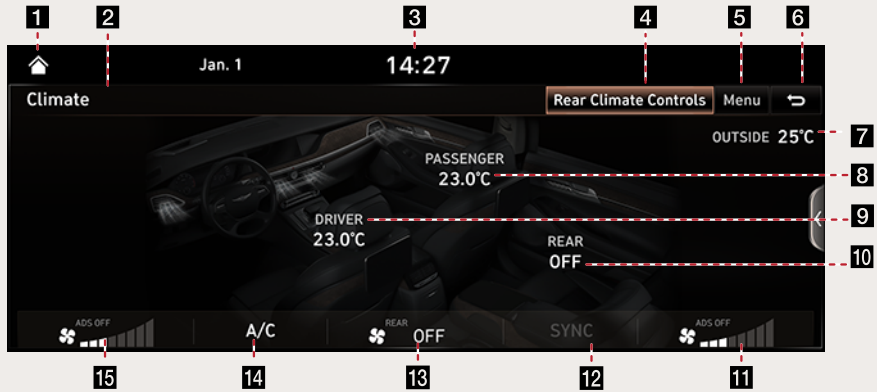

It moves to the [HOME] screen.

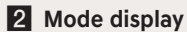

It displays the current mode.



It moves to the [Date/Time settings] screen.



It moves to the [Rear climate control] screen.



It displays the [Climate] menu.



It moves to the previous screen.



It displays the outside temperature of the vehicle.

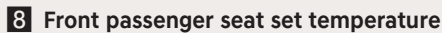

It displays the set temperature of the front passenger seat.

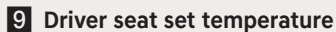

It displays the set temperature of the driver seat.

**10 Rear seat set temperature**

It displays the temperature of the rear seat.

11 Front passenger seat set blower level

It displays the set blower level of the front passenger seat.

12 SYNC

When the SYNC is active, front passenger seat set temperature is set based on driver seat set temperature.

13 Rear seat set blower level

It displays the set blower level of the rear seat.

14 A/C

When the A/C is active, air conditioner is operated for vehicle cooling.

15 Driver seat set blower level

It displays the set blower level of the driver seat.



REAR CLIMATE CONTROLS

Press [HOME] or [↑] > [Climate] > [Rear Climate Controls].



It moves to the [HOME] screen.



It displays the current mode.



It moves to the [Date/Time settings] screen.



It displays the [Rear climate control] menu.



It moves to the previous screen.



It displays the set blower level.



It is used to turn the rear climate device on/off.

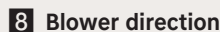

It displays the set blower direction.



When the AUTO is active, the blower level and cooling/heating are automatically operated according to the set temperature.



It displays the temperature of the rear seat.



CLIMATE MENU

Press [HOME] or > [Climate] > [Menu].

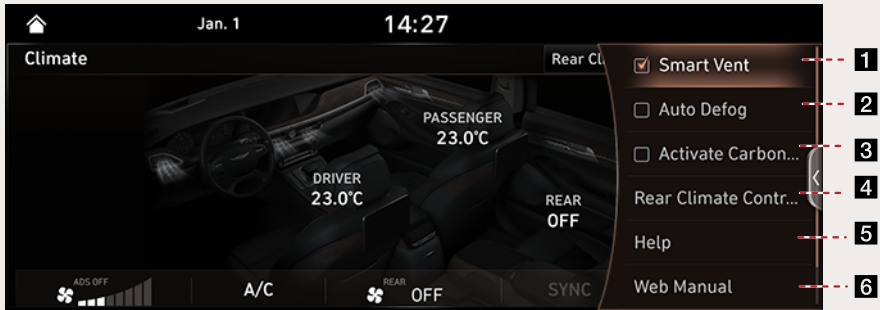

1 Smart Ventilation

When humidity and carbon dioxide levels inside the car increase while climate control is turned off, air is automatically expelled to maintain a comfortable environment.

2 Auto Defog

The air conditioner is automatically operated to create a flow of air to clear the windscreen.

3 Active Carbon Dioxide Monitor (Option)

Controls carbon dioxide concentration in the vehicle, improving freshness.

4 Rear climate control

It moves to the [Rear climate control] screen.

5 Help

It moves to the [Help] screen.

6 Web manual

Displays the QR code for the manual of corresponding function.

NOTE

While other modes (AV, Navigation, etc.) are in operation, if climate operation key is pressed, climate status is displayed at the top part of the screen.



REFERENCE





PRECAUTIONS FOR SAFETY

NOTATIONS USED WITHIN THIS USER'S MANUAL

	<div style="border: 1px solid black; padding: 5px;"> <p>CAUTION</p> <p>RISK OF ELECTRIC SHOCK</p> <p>DO NOT OPEN</p> </div>	
<p>CAUTION: TO REDUCE THE RISK OF ELECTRIC SHOCK, DO NOT REMOVE THE COVER (OR BACK). NO USER SERVICEABLE PARTS INSIDE, REFER SERVICING TO QUALIFIED SERVICE PERSONNEL.</p>		



The lightning flash with the arrowhead symbol within an equilateral triangle is intended to alert the user about the presence of uninsulated dangerous voltage within the product's enclosure that may be of sufficient magnitude to constitute a risk of electric shock.



The exclamation point within an equilateral triangle is intended to alert the user to the presence of important operating and maintenance (servicing) instructions in the literature accompanying the appliance.



Always operate the vehicle in a safe manner. Do not become distracted by the vehicle while driving and always be fully aware of all driving conditions. Do not change settings or any functions. Pull over in a safe and legal manner before attempting such operations.

To promote safety, certain functions are disabled unless the parking brake is on.



To reduce the risk of electric shock, do not remove the cover or back of this product. There are no user-serviceable parts inside. Refer servicing to qualified service personnel.



To reduce the risk of fire or electric shock, do not expose this product to dripping or splashing water, rain, or moisture.



When driving your vehicle, be sure to keep the volume of the unit low enough to allow you to hear sounds coming from the outside.



Do not drop it and avoid heavy impacts at anytime.



The driver should not watch the monitor while driving. If the driver watches the monitor while driving, it may lead to carelessness and cause an accident.

**WARNING:**

- Don't use a cellular phone when you are driving. You must stop at a safe place to use a cellular phone.
- The use of the navigation radio by no means relieves the driver of his/her responsibilities. The highway code must always be observed. Always observe the current traffic situation.
- The applicable traffic regulations and the prevailing traffic situation always take precedence over the instructions issued by the navigation system if they contradict one another.
- For traffic safety reasons, use the navigation system menus only before starting a journey or when the vehicle is stationary.
- In certain areas, one-way streets and turn off and entry prohibitions (e.g. pedestrian zones) are not recorded. In areas such as these the navigation system will issue a warning. Pay particular attention to one-way streets and turn off and entry restrictions.
- The navigation system does not take the relative safety of the suggested routes into consideration. Road blocks, building sites, height or weight restrictions, traffic or weather conditions or other influences which affect the route safety or travel time are not taken into consideration for the suggested routes. Use your own discretion in order to decide on the suitability of the suggested routes.
- The current legal road traffic speed limit always takes priority over the values saved on the data. It is impossible to provide an assurance that the speed values of the navigation system will always match those of the current traffic regulations in every situation.
- Always observe the applicable legal speed limits the traffic regulations. The vehicle speedometer must always be given priority for display of the vehicle speed.
- Do not rely exclusively on the navigation system when attempting to locate an emergency service (hospital, fire service etc.). It cannot be guaranteed that all available emergency services in your vicinity are saved in the database. Use your own discretion and abilities to secure help in such situations.



CAUTION:

<USA>

Complies with 21 CFR 1040.10 and 1040.11 except for deviations pursuant to Laser Notice No. 50, dated June 24, 2007

name : LG Electronics INC.

address : 128, YEOUIDAERO, YEONGDEUNGPOGO, SEOUL, KOREA

place : Made in Korea

CAUTION:

- This product employs a Laser system. Should the unit require maintenance, contact an authorized service center.
- Use of controls or adjustments or performance of procedures other than those specified herein may result in hazardous radiation exposure.

**CAUTION:**

- Do not keep the navigation system running with the engine stopped. Doing so may discharge the vehicle battery. When you use the navigation system, always keep the engine running.
- When the driver wants to operate the navigation system, first park the vehicle in a safe location and set the parking brake. Operating the system while driving can distract the driver and may result in a serious accident.
- Do not disassemble or modify this system. If you do, it may result in accidents, fire, or electrical shock.
- Some states/provinces may have laws limiting the use of video screens while driving. Use the system only where it is legal to do so.
- Do not use your phone in private mode when you are driving. You must stop at a safe location to use it.

FCC NOTICE (FOR USA)

This equipment has been tested and found to comply with the limits for a Class B digital device, pursuant to Part 15 of the FCC Rules. These limits are designed to provide reasonable protection against harmful interference in a residential installation. This equipment generates, uses and can radiate radio frequency energy and, if not installed and used in accordance with the instructions, may cause harmful interference to radio communications. However, there is no guarantee that interference will not occur in a particular installation. If this equipment does cause harmful interference to radio or television reception, which can be determined by turning the equipment off and on, the user is encouraged to try to correct the interference by one or more of the following measures:

- Reorient or relocate the receiving antenna.
- Increase the separation between the equipment and the receiver.
- Connect the equipment to an outlet on a circuit different from that to which the receiver is connected.
- Consult the dealer or an experienced radio/TV technician for help.

This device complies with part 15 of the FCC Rules. Operation is subject to the following two conditions:

(1) this device may not cause harmful interference and

(2) this device must accept any interference received, including interference that may cause undesired operation. Any changes or modifications in construction of this device which are not expressly approved by the party responsible for compliance could void the user's authority to operate the equipment.



FCC RF RADIATION EXPOSURE STATEMENT

[For having wireless function]

This equipment complies with FCC radiation exposure limits set forth for an uncontrolled environment. This transmitter must not be colocated or operating in conjunction with any other antenna or transmitter. This equipment should be installed and operated with minimum distance 20 cm (7,8 inches) between the radiator and your body. Users must follow the specific operating instructions for satisfying RF exposure compliance.

INDUSTRY CANADA STATEMENT

[For having wireless function]

This device contains licence-exempt transmitter(s)/receiver(s) that comply with Innovation, Science and Economic Development Canada's licence-exempt RSS(s). Operation is subject to the following two conditions:

- (1) This device may not cause interference.
- (2) This device must accept any interference, including interference that may cause undesired operation of the device.

IC RADIATION EXPOSURE STATEMENT (FOR CANADA)

[For having wireless function]

This equipment complies with IC radiation exposure limits set forth for an uncontrolled environment. This equipment should be installed and operated with minimum distance 20 cm (7,8 inches) between the antenna & your body.

NOTE: THE MANUFACTURER IS NOT RESPONSIBLE FOR ANY RADIO OR TV INTERFERENCE CAUSED BY UNAUTHORIZED MODIFICATIONS TO THIS EQUIPMENT. SUCH MODIFICATIONS COULD VOID THE USER'S AUTHORITY TO OPERATE THE EQUIPMENT.



GENERAL INFORMATION

INFORMATION ON DISC





CAUTIONS TO USE DISC

- Preserve a disc in a case after use to prevent scratches.
- Using a disc in an abnormal shape (8 cm, heart shape, pentagonal shape) may cause failures.
- Do not clean a disc using alcohol, benzene, thinner or other chemical solvents. Such chemical solvents damage the disc surface.
- Exposure under direct sunlight, high humidity or temperature for a long time period may deform a disc.
- Playing a disc that is stained by foreign materials or deformed may result sound skipping or sound or video quality degrade. And writing on the both surfaces of disc may damage the disc surface.
- Clean the finger prints and/or dusts on the disc surface (data recorded surface) carefully using soft cloth.
- Data CD is not played. (However, some discs are abnormally played.)
- Be cautious not to have any foreign material other than a disc inserted in the disc slot. Foreign materials may damage the interior of the device.
- The device may fail for normal operation under an extremely high or low temperature.
- Moistures can be set on the lens during a raining or highly humid or immediately after turning the heater on in the vehicle. In this case, the normal operation fails because the device cannot read the disc. Eject the disc and wait until the moistures are dried off.
- Long-term driving on rough road surface or any severe impact on the vehicle may result abnormal disc play.
- Do not attach any sticker or label on the disc. Removed sticker or label during play may damage the system.
- Do not insert two or more discs simultaneously in the disc slot. That may damage the disc player.
- Do not hold or pull the disc while it is loaded in the disc player by the automatic loading mechanism. That may damage the disc and the disc player.
- Discs other than the genuine products may cause recognition failure and/or the system damage.



PLAYABLE DISCS



This device may play the following disc types: Some disc formats, recording types and device types may fail the play.

Playable Discs	Disc Label	Description
DVD Video		Only the discs with the region code of 3 or All are available for play.
Audio CD (Audio CD)		Plays general audio CDs.
CD-R/RW	 	Plays discs containing music title, WMA and/or MP3 files.

ON COPYRIGHT

The copyright protection technologies on this device are patented by and/or are intellectual properties of U.S. Macrovision and other related organizations. Therefore, any duplication, rental, use in any public place, broadcasting and/or exhibition without proper permissions is prohibited by the laws. Also, any unauthorized engineering change on this device is prohibited.

DVD REGIONAL CODES

This device has been produced according to the regional code recorded in the dvd. Any DVD having the regional code not identical to a regional code of this device is not playable. The regional code of this device is  or .



CAUTIONS FOR THE USE OF USB

Connect a USB device after starting the engine. If the engine is started with a USB device installed, a USB device can be damaged.

If it is not a standard format file, it is not played.

- MP3/WMA file only supports a music file with a compression level of 8 Kbps to 320 Kbps.
- Be cautious for statics on connecting/disconnecting a USB device.
- If encrypted MP3 player is connected to an external USB device, it is not recognized.
- When connecting a USB external device, it may not be recognized depending on the condition of a USB external device.
- FAT 16, FAT 32, exFAT and NTFS are supported.
- Some USB devices may not be supported due to compatibility issue.
- Avoid any touch on the USB connection area by any human body or material.
- Connecting and disconnecting a USB device for a short time repeatedly can cause its failure.
- Connect or disconnect a USB device after the audio power is off.
- The recognition time can vary depending on the type, capacity and format of a stored file but it is not a product failure.
- USB device connected via a USB HUB or extension cable may cause the recognition failure. Use a USB device directly connecting to the infotainment system of the vehicle.
- When uploading an application program in a specific USB, the file may not be played.
- When the USB device, that is not recognized as removable discs like MP3 Player, mobile phone and digital camera, was connected, it may not be operated properly.
- The charge through USB may not be supported in case of some mobile devices.
- No operation may be guaranteed except standard product (Metal Cover Type) USB memory.
- The operation of HDD Type, CF and SD memory is not guaranteed.
- The file that applied DRM (Digital Rights Management) is not played.
- The USB memory stick (SD Type or CF Type) used by being inserted into an adapter may not be recognized.



PLAYABLE FILE STANDARD

PLAYABLE AUDIO FILE SPECIFICATIONS (USB)

- Playable File Types: “.mp3”, “.wma”, “.mka”, “.wav”
- Sampling Frequency: 8 - 48 KHz (MP3), 22.5 - 48 KHz (WMA) , 8 - 48KHz(PCM/WAV), 8 - 44KHz(ADPCM/WAV), 8 - 48 KHz (AC-3), 8 - 48 KHz (AAC)
- Playable Codec Types: “MPEG-1 layer I, II, III”, “AC-3”, “AAC”, “WMA”, “PCM (WAV only)”, “ADPCM(WAV only)”
- Bit rate: 8 - 320 Kbps (MP3), 20 - 320 Kbps (WMA) , 8 - 12.3Mbps (PCM/WAV), 8 - 352.8Kbps (ADPCM/WAV), 8 - 320Kbps (AC-3) , 8 - 320 Kbps (AAC)

PLAYABLE AUDIO FILE SPECIFICATIONS (DISC)

CD-ROM File Formats: Only ISO9660/JOLIET ISO9660, JOLIET formats are displayed.

DIVX FILE STANDARD

- Playable video file standard
 - Playable file format : “.avi”, “.mpg”, “.mpeg”, “.divx”, “.mp4”, “.asf”, “.wmv”, “.mkv”
 - Playable Codec Types: “MPEG-1”, “MPEG-2 simple profile - main level”, “MPEG-2 main profile - low,main,high level”, “VC-1”, “AVC”, “H.263 profile 0 ~ profile2”, “MPEG4 v2,v3”, “DIVX 3.11, 4,5,6”, “Xvid”
 - Playable resolution and frame rate: (MPEG-1) within 1280 x 720 30fps, 720 x 480p 30fps / 720 x 576p 25fps (H.263), 720 x 480p 30fps / 720 x 576p 25fps (Divx 3.11), 1920 x 1038 30fps (Divx 4,5,6), 1920 x 1080 30fps (other supported Codec format)
- Playable subtitle standard
 - Playable file format : “.smi”, “.srt”
 - Playable subtitle language : Korean, English, Japanese, Chinese
 - When the file name of image and subtitles is different, subtitles may not be displayed.
- The file name of DivX subtitle can be typed up to 45 letters in English and 22 letters in Korean alphabet.
- The code that cannot be shown is displayed as “_”.
- When DivX file format does not match the main body, it may not be played normally.



THE INFORMATION ABOUT IPOD

iPod is a registered trademark of Apple Inc.

PRECAUTIONS FOR THE USE OF IPOD

- Since communications protocol is not provided for some iPod, it may not be played.
- If an iPod fails due to its own malfunction, use the iPod after reset. (See the owner's manual)
- iPod is charged if it is connected by a cable for iPod only with the ACC on.
- Use an exclusive iPod cable to play iPod. If it is not a cable for iPod only, its operation is not guaranteed.
- Use an iPod after synchronized with iTunes. Adding/Deleting any song can cause abnormal operation.
- If iPod and Bluetooth are connected with the same iPhone, the audio function in Bluetooth cannot be used.
- iOS10.3.2 or higher is recommended in using an iPod touch or iPhone.

IPOD LISTS THAT RECEIVE SUPPORT

- iPhone 7 Plus, iPhone 7, iPhone SE
- iPhone 6s Plus, iPhone 6s, iPhone 6 Plus, iPhone 6
- iPhone 5s, iPhone 5c, iPhone 5
- iPhone 4s
- iPad Pro (12.9-inch) 1st Generation, iPad Pro (9.7-inch)
- iPad mini 4, iPad mini 3, iPad mini 2, iPad mini
- iPad Air 2, iPad Air
- iPad (4th generation), iPad (3rd generation), iPad 2
- iPod touch (6th generation), iPod touch (5th generation)
- iPod nano (7th generation)



BEFORE THINKING THE PRODUCT HAS MALFUNCTIONED

The current position as shown on the navigation may differ from the actual position under the following conditions. The following occurrences are not malfunctions:

- When driving on Y-shaped roads with narrow angles the current position may be displayed in the opposite direction.
- Within city streets, the current position may be displayed on the opposite side or on an off-road position.
- When changing the zoom level from maximum to a different level, the current position may become displayed on a different road.
- If the vehicle is loaded onto a ferry or a car transport vehicle, the current position may become stalled on the last position prior to loading.
- When driving on a spiral-shaped road.
- When driving in mountain regions with sharp turns or sudden brakes.
- When entering a road after passing an underground parking structure, building parking structure, or roads with many rotations.
- When driving in heavy traffic with frequent starts and stops.
- When driving under slippery conditions, such as heavy sand, snow, etc.
- When the tires have recently been replaced. (Especially upon use of spare or studless tires.)
- When using tires of improper size.
- When the tire pressure for the 4 tires are different.
- When the replacement tire is worn or used. (Especially studless tires having passed a second season.)
- When driving near high-rise buildings.
- When a roof carrier has been installed.
- When a long distance route is calculated while driving on an expressway, in such cases, continued driving will automatically enable the system to conduct map matching or use updated GPS information to provide the current position. (In such cases, up to several minutes may be required.)



Correct route guidance may not occur due to search conditions or driving position. The following occurrences are not malfunctions:

- Guidance to go straight may be given while driving on a straight road.
- Guidance may not be given even when having turned at an intersection.
- There are certain intersections in which guidance may not occur.
- A route guidance signaling for a u-turn may occur in some No u-turn intersections.
- Route guidance signaling entrance into a No-entry zone may occur. (No-entry zone, road under construction, etc.)
- Guidance may be given to a position that is not the actual destination if roads to reach the actual destination do not exist or are too narrow.
- Faulty voice guidance may be given if the vehicle breaks away from the designated route. (e.g. if a turn is made at an intersection while the navigation provided guidance to go straight.)

These situations may occur after conducting route calculation. The following occurrences are not malfunctions:

- Guidance may be given to a position differing from the current position when turning at an intersection.
- When driving in high speeds, route recalculation may take a longer period of time.
- Route guidance signaling for a u-turn may occur in some No u-turn intersections.
- Route guidance signaling entrance into No-entry zone may occur. (No-entry zone, road under construction, etc.)
- Guidance may be given to a position removed from the actual destination if roads to reach the actual destination do not exist or are too narrow.
- Faulty voice guidance may be given if the vehicle breaks away from the designated route. (e.g. If a turn is made at an intersection while the navigation provided guidance to go straight.)



BEFORE YOU THINK THE PRODUCT IS DEFECTIVE

1. Errors which occur during the operation or installation of the device may be mistaken as a malfunction of the actual device.
2. If you are having problems with the device, try the suggestions listed below.
3. If the problems persist, contact your dealer.

Problem: There are small red, blue, or green dots on the screen

Possible Cause : Because the LCD is manufactured with technology requiring high point density, a pixel or lighting deficiency may occur within 0.01% of total pixels.

Problem: The sound or image is not working

Possible Cause :

- Has the Switch for the vehicle been turned to [ACC] or [ON]?
- Has the SYSTEM been turned OFF?

Problem: The screen is being displayed but sound is not working

Possible Cause :

- Has the volume been set to a low level?
- Has the volume been muted?

Problem: When the power is turned on, the corners of the screen are dark

Possible Cause :

- The display appearing somewhat dark after prolonged periods of use is normal with LCD panels. It is not a malfunction.
- If the screen is very dark, contact your nearest dealer for assistance.

Problem: Sound is working from only one speaker

Possible Cause : Are the positions of Fader or Balance sound controls adjusted to only one side?

Problem: The external device is not working

Possible Cause : Is the external device connected with a standard connector cable?



Problem: When turning power on, the most recent mode screen is not displayed

Possible Cause :

- Within modes that play files by reading external sources, such as USB, iPod, or Bluetooth® streaming mode, the most recently played mode screen prior to turning off power may not properly load.
- If there is no the corresponding device is not connected, the mode operated prior to the most recent mode will operate.
- If the previous mode still cannot be properly played, the mode operated prior to that will operate.



TROUBLESHOOTING

Problem: The power does not turn on.
<ul style="list-style-type: none"> • Possible Cause : The fuse is disconnected. • Countermeasure: <ul style="list-style-type: none"> - Replace with a suitable fuse. - If the fuse is disconnected again, please contact your dealer.
<ul style="list-style-type: none"> • Possible Cause : Device is not properly connected. • Countermeasure: Check to see that the device has been properly connected.
Problem: The system does not play.
<ul style="list-style-type: none"> • Possible Cause : The disc has not been inserted or has been inserted upside down. • Countermeasure: Insert the disc properly so that the sides are facing the correct direct.
<ul style="list-style-type: none"> • Possible Cause : The disc has been contaminated. • Countermeasure: Wipe away dirt and other foreign substances from the disc.
<ul style="list-style-type: none"> • Possible Cause : The vehicle battery is low. • Countermeasure: Charge the battery if the problem persists, contact your point of purchase or service center.
<ul style="list-style-type: none"> • Possible Cause : A disc not supported by the device has been inserted. • Countermeasure: Insert a disc which is supported by the device.
Problem: The image color/tone quality is low.
<ul style="list-style-type: none"> • Possible Cause : The brightness, saturation, and contrast levels are not set properly. • Countermeasure: Properly adjust the brightness, saturation, and contrast levels through Display Setup.
Problem: Sound does not work.
<ul style="list-style-type: none"> • Possible Cause : The volume level is set to the lowest level. • Countermeasure: Adjust the volume level.
<ul style="list-style-type: none"> • Possible Cause : The connection is not proper. • Countermeasure: Check to see that the device has been properly connected.
<ul style="list-style-type: none"> • Possible Cause : The device is currently fast-forwarding, rewinding, scanning, or playing in slow mode. • Countermeasure: The sound will not work when the device is fast-forwarding, rewinding, scanning, or playing in slow mode.



Problem: The sound or image quality is low.
<ul style="list-style-type: none"> • Possible Cause : The disc is dirty or scratched. • Countermeasure: Wipe off water or dirt from the disc. Do not use a disc which has been scratched.
<ul style="list-style-type: none"> • Possible Cause : Vibration is occurring from where the conversion switch has been installed. • Countermeasure: The sound may be short circuited and the image distorted if the device vibrates.
Problem: The USB does not work
<ul style="list-style-type: none"> • Possible Cause : USB memory is damaged. • Countermeasure: Please use after formatting the USB into FAT 16/32, exFAT, NTFS format.
<ul style="list-style-type: none"> • Possible Cause : USB memory has been contaminated. • Countermeasure: Remove any foreign substances on the contact surface of the USB memory and infotainment system.
<ul style="list-style-type: none"> • Possible Cause : A separately purchased USB HUB is being used. • Countermeasure: Directly connect the USB memory with the infotainment system on the vehicle.
<ul style="list-style-type: none"> • Possible Cause : A USB extension cable is being used. • Countermeasure: Directly connect the USB memory with the infotainment system on the vehicle.
<ul style="list-style-type: none"> • Possible Cause : A USB which is not a Metal Cover Type USB Memory is being used. • Countermeasure: Use standard USB Memory.
<ul style="list-style-type: none"> • Possible Cause : An HDD type, CF, SD Memory is being used. • Countermeasure: Use standard USB Memory.
<ul style="list-style-type: none"> • Possible Cause : There are no music files which can be played. • Countermeasure: Only MP3, WMA file formats are supported. Please use only the supported music file formats.

**Problem: The iPod is not recognized even though it has been connected**

- Possible Cause : There are no titles which can be played.
- Countermeasure: Use iTunes to download and save MP3 files into the iPod.
- Possible Cause : The iPod firmware version has not been properly updated.
- Countermeasure: Use iTunes to update the firmware version and reconnect the iPod with the device.
- Possible Cause : The iPod device does not recognize downloads.
- Countermeasure: Reset the iPod and reconnect with the device.



TRADEMARKS AND LICENSES

IPOD®

iPod® is a registered trademark of Apple Inc.

SIRIUSXM™



SiriusXM™ is a registered trademark of SiriusXM™ Satellite Radio Inc. All rights reserved.

DTS®



The production complies with U.S. Patent No. 5,956,674; 5,974,380; 6,487,535. The patents of outside of the U.S. and the worldwide have been issued or are pending. DTS and its symbols are registered trademarks. & DTS Digital Surround logos are the registered trademarks of DTS, Inc. This product includes software. © DTS, Inc. All Rights Reserved.

BLUETOOTH® WIRELESS TECHNOLOGY



Bluetooth® word mark and logo is a registered trademark of Bluetooth SIG, Inc. and all the Bluetooth marks and logos are under the license. In order to use Bluetooth wireless technology, a mobile phone, that Bluetooth function is supported, is required.

HD RADIO™ TECHNOLOGY



HD Radio Technology manufactured under license from iBiquity Digital Corporation. U.S. and Foreign Patents. For patents see <http://dts.com/patents>. HD Radio, Artist Experience, and the HD, HD Radio, and "ARC" logos are registered trademarks or trademarks of iBiquity Digital Corporation in the United States and/or other countries.



NAVIGATION

END USER LICENSE AGREEMENT

PLEASE READ THIS END USER LICENSE AGREEMENT (“EULA”) CAREFULLY BEFORE USING THE NAVIGATION SYSTEM.

This is a license agreement between you and HYUNDAI MNSOFT, INC., including its affiliates (“COMPANY”) regarding a copy of COMPANY navigable map database together with associated software, media and explanatory printed documentation published by COMPANY (jointly the “Product”). The Product is provided for your personal, internal use only and not for resale. It is protected by copyright and is subject to the following terms which are agreed to by you, on the one hand, and COMPANY and its licensors (and their licensors and suppliers) (collectively, “Licensors”) on the other hand.

By using the Product, you accept and agree to all terms and conditions in this End User License Agreement (“EULA”). IF YOU DO NOT AGREE TO THE TERMS OF THIS EULA, YOU MUST PROMPTLY EXIT THE PRODUCT OPERATION PROGRAM AND DO NOT USE OR ACCESS TO THE PRODUCT. You agree that your rights under this EULA may be terminated automatically without notice if you fail to comply with any term(s) of this EULA.

TERMS AND CONDITIONS

Personal Use Only. You agree to use this Product together with COMPANY authorized application for the solely personal, non-commercial purposes for which you were licensed, and not for service bureau, time-sharing or other similar purposes. Accordingly, but subject to the restrictions set forth in the following paragraphs, you agree not to otherwise reproduce, copy, modify, decompile, disassemble, create any derivative works of, or reverse engineer any portion of this Data, and may not transfer or distribute it in any form, for any purpose, except to the extent permitted by mandatory laws. You may not assign this EULA or any of the rights or licenses granted under this EULA, except when installed in the system for which it was created.

Restrictions. Except where you have been specifically licensed to do so by COMPANY, and without limiting the preceding paragraph, you may not use the Product (i) with any products, systems, or applications installed or otherwise connected to or in communication with vehicles, capable of vehicle navigation, positioning, dispatch, real time route guidance, fleet management or similar applications; or (ii) with or in communication with any positioning devices or any mobile or wireless-connected electronic or computer devices, including without limitation cellular phones, palmtop and handheld computers, pagers, and personal digital assistants or PDAs.



COPYING OR USE OF THE PRODUCT EXCEPT AS PERMITTED BY THIS EULA IS UNAUTHORIZED AND IS COPYRIGHT INFRINGEMENT UNDER THE LAWS OF YOUR COUNTRY. IF YOU COPY OR USE THE PRODUCT WITHOUT COMPANY PERMISSION, EXCEPT AS PERMITTED BY THIS EULA, YOU ARE VIOLATING THE LAW AND LIABLE TO COMPANY AND ITS LICENSORS FOR DAMAGES, AND YOU MAY BE SUBJECT TO CRIMINAL PENALTIES.

THE PRODUCT MAY INCLUDE ENFORCEMENT TECHNOLOGY DESIGNED TO PREVENT (i) UNAUTHORIZED COPYING OF THE PRODUCT ONTO PHYSICAL STORAGE MEDIA OR VIA TRANSFER OVER THE INTERNET OR OTHER ELECTRONIC COMMUNICATION MEANS AND/OR (ii) ILLEGAL USAGE OF THE PRODUCT OTHER THAN BY A SPECIFICALLY AUTHORIZED DEVICE. YOU AGREE THAT COMPANY MAY USE THESE MEASURES TO PROTECT COMPANY AND THE LICENSORS AGAINST COPYRIGHT INFRINGEMENT.

Uploads. The Product may provide functionality through which you are able to upload certain information about your use of the Product (collectively, “Uploads”) to COMPANY servers or receive other services from COMPANY (collectively, the “Services”). If you use such functionality, you authorize COMPANY to retain your Uploads on its servers. COMPANY will have no obligation to provide any Services, may change the form and nature of any Services at any time with or without notice to you, will have no liability whatsoever to you for any failure of the Product or Services to transmit your Uploads to or from COMPANY servers, may cease providing any Services at any time with or without notice to you, and will have no obligation to retain your Uploads (or any other materials you may provide to COMPANY) on its servers or return your Uploads (or any other materials you may provide to COMPANY) to you before deleting them from its servers.

Storage. The Product may provide functionality through which you are able to store information (such as images) on the device on which you are using the Product. COMPANY will have no liability whatsoever to you or any third party for any failure of the Product to store any such information on such device.

Personal Information. By using the Product, you agree to the collection, retention and processing of your personal data (including the location of your mobile device) by COMPANY and to the storage and processing of such personal information on computers located outside of the country in which you reside. Even though COMPANY has taken steps intended to protect your personal information from being intercepted, accessed, used, or disclosed by unauthorized persons, COMPANY cannot fully eliminate security risks associated with your personal information and cannot guarantee that its systems will not be breached. See [*] for additional information regarding COMPANY’s use of your personal information.

Warning. The Product reflects reality as existing before you received the product and it comprises data and information from government other sources. accordingly, the product may contain inaccurate or incomplete information due to the passage of time, changing circumstances, sources used and the nature of collecting comprehensive geographic product, any of which may lead to incorrect results.

THE PRODUCT AND SERVICES MAY NOT TO BE USED FOR SAFETY OF LIFE APPLICATIONS, OR FOR ANY OTHER APPLICATION IN WHICH THE ACCURACY OR RELIABILITY OF THE PRODUCT OR SERVICES COULD CREATE A SITUATION WHERE PERSONAL INJURY OR DEATH MAY OCCUR.



DO NOT ATTEMPT TO CONFIGURE THE PRODUCT OR INPUT INFORMATION WHILE DRIVING. FAILURE TO PAY FULL ATTENTION TO THE OPERATION OF YOUR VEHICLE COULD RESULT IN DEATH, SERIOUS INJURY, OR PROPERTY DAMAGE. BY USING THE PRODUCT, YOU ASSUME ALL RESPONSIBILITY AND RISK.

Disclaimer of Warranty. The Product is provided to you “as is,” and you agree to use it at your own risk. SUBJECT TO THE APPLICABLE LAWS, COMPANY AND THE LICENSORS MAKE NO GUARANTEES, REPRESENTATIONS OR WARRANTIES OF ANY KIND, EXPRESS OR IMPLIED, ARISING BY LAW OR OTHERWISE, INCLUDING BUT NOT LIMITED TO, content, QUALITY, accuracy, completeness, effectiveness, reliability, PERFORMANCE, MERCHANTABILITY, FITNESS FOR A PARTICULAR PURPOSE, NON-INFRINGEMENT, usefulness, use or results to be obtained from the Product, or that the Product or server will be uninterrupted or error-free, OR THAT ERRORS IN THE PRODUCT OR NONCONFORMITY TO ITS DOCUMENTATION CAN OR WILL BE CORRECTED. YOU ACKNOWLEDGE THAT THE PROVISIONS OF THIS SECTION ARE A MATERIAL INDUCEMENT AND CONSIDERATION TO COMPANY AND THE LICENSORS TO GRANT THE LICENSE CONTAINED IN THIS EULA AND TO PROVIDE YOU WITH ACCESS TO THE SERVICES.

Limitation of Liability: TO THE MAXIMUM EXTENT PERMITTED UNDER THE APPLICABLE LAWS, COMPANY AND THE LICENSORS SHALL NOT BE LIABLE TO YOU: IN RESPECT OF ANY CLAIM, DEMAND OR ACTION, IRRESPECTIVE OF THE NATURE OF THE CAUSE OF THE CLAIM, DEMAND OR ACTION ALLEGING ANY LOSS, INJURY OR DAMAGES, DIRECT OR INDIRECT, INCURRED BY YOU OR ANY THIRD PARTY WHICH MAY ARISE IN CONNECTION WITH OR RESULT FROM THE USE OR POSSESSION OF THE PRODUCT; OR FOR ANY LOSS OF DATA, PROFIT, REVENUE, CONTRACTS OR SAVINGS, OR OTHER DIRECT, INDIRECT, INCIDENTAL, SPECIAL OR CONSEQUENTIAL DAMAGES ARISING OUT OF YOUR USE OF OR INABILITY TO USE THE PRODUCT, ANY DEFECT IN THE PRODUCT, OR THE BREACH OF THESE TERMS OR CONDITIONS, WHETHER IN AN ACTION IN CONTRACT OR TORT OR BASED ON A WARRANTY, EVEN IF COMPANY OR THE LICENSORS HAVE BEEN ADVISED OF THE POSSIBILITY OF SUCH DAMAGES AND NOTWITHSTANDING THE FAILURE OF ANY LIMITED REMEDY PROVIDED HEREIN.



Exclusions. Some jurisdictions do not allow certain warranty exclusions or the limitation or exclusion of liability, so to that extent the above exclusion may not apply to you. To the extent that COMPANY may not, as a matter of applicable law, disclaim any implied warranty or limit its liabilities, the scope and duration of such warranty and the extent of COMPANY's liability shall be the minimum permitted under such applicable law. The disclaimer of warranty and limitation of liability set forth in this EULA does not affect or prejudice your statutory rights where you have acquired the Product otherwise than in the course of business.

Third-Party Copyright Notices. The third-party sourced data has been incorporated into or made a part of the Product and is being sublicensed to you subject to the terms and conditions of this EULA. In this regard, you shall not remove or tamper with any intellectual property rights notice attached or used in relation to data supplied by the Licensors.

Entire Agreement. This EULA is the entire agreement between COMPANY (and the Licensors) and you pertaining to the subject matter hereof, and supersedes in their entirety any and all previous written or oral communications or documents (including, if you are obtaining an update, any agreement that may have been included with an earlier version of the Product) with respect to such subject matter.

Governing Law. This EULA shall be governed by the laws of the jurisdiction in which you reside at the date of acquisition of the Product. Should you at that moment reside outside the European Union or Switzerland, the law of the jurisdiction within the European Union or Switzerland where you acquired the Product shall apply. In all other cases, or if the jurisdiction where you acquired the Product cannot be defined, the laws of the Republic of Korea shall apply. This EULA will not be governed by the U.N. Convention on Contracts for the International Sale of Goods. The courts competent at your place of residence at the time you acquired the Product shall have jurisdiction over any dispute arising out of, or relating to this EULA, without prejudice to COMPANY's right to bring claims at your then current place of residence.

Export Control. You agree not to export or re-export from anywhere any part of the Product in any form except in compliance with applicable export laws, rules and regulations, including but not limited to the laws, rules and regulations administered by the Office of Foreign Assets Control of the U.S. Department of Commerce and the Bureau of Industry and Security of the U.S. Department of Commerce.



Miscellaneous. If any provision of this EULA is found to be invalid or unenforceable, it will be enforced to the extent permissible and the remainder of this EULA will remain in full force and effect. Failure by COMPANY to prosecute any right with respect to a default hereunder will not constitute a waiver by COMPANY of the right to enforce rights with respect to the same or any other breach. No refunds or replacements will be permitted on damaged Product.

U.S. Government End Users. If the Product is being acquired by or on behalf of the United States Government or any other entity seeking or applying rights similar to those customarily claimed by the United States Government, this Product and related documentation are "Commercial Items" as that term is defined at 48 C.F.R. ("FAR") 2.101. This Product and related documentation are licensed to the United States Government end users (a) only as "Commercial Items" and (b) with only those rights as are granted to all other end users in accordance with this EULA, and each copy of Product delivered or otherwise furnished shall be marked and embedded as appropriate with the following "Notice of Use," and shall be treated in accordance with such Notice:



Notice of Use

Contractor (Manufacturer/ Supplier) Name: HYUNDAI MNSOFT, INC.

This Product and related documentation are commercial items as defined in FAR 2.101 and is subject to this EULA under which this Product is provided.

© 20XX HYUNDAI MNSOFT. All rights reserved.

If the Contracting Officer, federal government agency, or any federal official refuses to use the legend provided herein, the Contracting Officer, federal government agency, or any federal official must notify COMPANY prior to seeking additional or alternative rights in the Product.

End-User Terms Required by HERE. The Product utilizes map data that COMPANY licenses from HERE and the following copyright notices apply to such map data (the "HERE Data"): © 20XX HERE. All rights reserved.

The HERE Data for areas of Canada includes information taken with permission from Canadian authorities, including: © Her Majesty the Queen in Right of Canada, © Queen's Printer for Ontario, © Canada Post Corporation, GeoBase.®, © Department of Natural Resources Canada. All rights reserved.

HERE holds a non-exclusive license from the United States Postal Service® to publish and sell ZIP+4® information.

©United States Postal Service® 20XX. Prices are not established, controlled or approved by the United States Postal Service®. The following trademarks and registrations are owned by the USPS: United States Postal Service, USPS, and ZIP+4.



COPYRIGHT FOR BRAND ICON

The marks of companies displayed by this product to indicate business locations are the marks of their respective owners. The use of such marks in this product does not imply any sponsorship, approval, or endorsement by such companies of this product.

COPYRIGHT FOR JUNCTION VIEW

Junction View Data provided by ZENRIN USA, INC. Copyright(C) 20XX, All rights Reserved.

ABOUT MAP UPDATES

You can contact your KIA dealer or Call HYUNDAI MNSOFT at 1-888-757-0010.

Information

This product requires regular updates for new functions and map updates. Updating may require up to 1 hour depending on the data size.

Turning off the power or ejecting the USB during the update process may result in damage to the system. Make sure to keep the ignition on and wait until updating is complete.

CAUTION

- The use of an uncertified USB may result in damage to the system due to heat related deformation.
- Product malfunctions caused by the use of an uncertified cards shall not be covered within the product warranty.
- Repeatedly connecting/disconnecting the USB in a short period of time may cause damage to the device.



SPECIFICATION

AV/NAVIGATION PRODUCT SPECIFICATION

Common	Power Supply	DC 14.4 V
	Operating Power	DC 9 V ~ DC 16 V
	Current Consumption	Maximum 6 A
	Dark Current	Maximum 1 mA
	Operating Temperature	-20 °C ~ +70 °C
	Storage Temperature	-40 °C ~ +85 °C
	Dimensions (Head unit)	296 (W) x 99 (H) X 208 (D) mm
	Weight (Head unit)	1.4 kg
	Name of the equipment (Model name)	Car Navigation System (IAN2270TNHI)
	Manufactured date	2018. 3.
	Manufacturer / Country	LG Electronics Co., Ltd. / Korea
Bluetooth	Supported Profile	HFP (1.7), A2DP (1.3) , AVRCP (1.6)
	Supported Bluetooth Specification	4.2
	Frequency Range	2402 MHz ~ 2480 MHz
	Output (Class2)	1.0 dBm
	Number of Channels	79
Radio	AM	
	Tuning range	530 kHz ~ 1710 kHz (Guam 531 ~ 1701 KHz)
	Sensitivity	35 dBuV
	Frequency response	30 Hz ~ 10000 Hz
	Signal-to-noise ratio	Minimum 45 dB
	FM	
	Tuning range	87,5 MHz ~ 107.9 MHz
	Sensitivity	10 dBuV
	Frequency response	30 Hz ~ 10000 Hz
	Signal-to-noise ratio	Minimum 50 dB
CD/DVD	FORMAT	CD-DA, CD-R, CD-RW, DVD (12 cm disc Only)
	Interface	Serial (TAB2)
	Signal-to-noise ratio	Minimum 70 dB
	Frequency response	20 Hz ~ 20 KHz (±3 dB)
	Distortion ratio	0,03%



TFT-LCD (12.3")	Screen Size	312.42 mm (12.3 inches) 292.03 (W) X 109.05 (H) mm (Active area)
	Resolution	1,382,400 pixel
	Operating Method	TFT (Thin Film Transistor) Active Matrix, In Plane Switching (IPS)
	Viewing Angle	89/89/89/89 (L,R,U,D)
	Internal Lighting	LED
TFT-LCD (9.2")	Screen Size	233.95 mm (9.2 inches) 204 (W) X 114.72 (H) mm (Active area)
	Resolution	921,600 pixel
	Operating Method	TFT (Thin Film Transistor) Active Matrix, In Plane Switching (IPS)
	Viewing Angle	89/89/89/89 (L,R,U,D)
	Internal Lighting	Viewing angle free (R/L 178 (Min.), UD 178 (Min.))
SiriusXM™	Frequency	2337,490 MHz ~2340,020 MHz
	Sensitivity	-80 dBm
	T,H,D	Maximum 0,2 %

- To obtain the source code under GPL, LGPL, MPL and other open source licenses, that is contained in this product, please visit <http://opensource.lge.com>. In addition to the source code, all referred license terms, warranty disclaimers and copyright notices are available for download. LG Electronics will also provide open source code to you on CD-ROM for a charge covering the cost of performing such distribution (such as the cost of media, shipping and handling) upon email request to opensource@lge.com. This offer is valid for three (3) years from the date on which you purchased the product.
- Designs and specifications are subject to change without prior notice.



CONNECTED SERVICES TERMINAL PRODUCT SPECIFICATION

Common	Power Supply	DC 14.4 V (Battery)
	Operating Power	DC 9 V ~ DC 16V
	Current Consumption	Max 2.5 A
	Dark current	Dark current within 168h: Max 10 mA (After ACC is off, average current for 168 hours) Dark current after 168h: Max 1 mA (After ACC is off and after 168 hours)
	Operating Temperature	-20 °C ~ +70 °C
	Storage Temperature	-40 °C ~ +85 °C
	External dimension	93 (W) x 8 (H) x 39 (D) mm
	Weight	40 g
	Name of equipment (model name)	Car Navigation System (IAN2270TNHI)
CDMA	Frequency	From Tx : 824 to 849MHz (BC0), 1850MHz~1910MHz (BC1) From Rx : 869 to 894MHz (BC0), 1930MHz~1990MHz (BC1)
	Receiving sensitivity	Less than -104 dBm (conducted)
	Transmission output	Power Class3 (BC0), Power Class2(BC1), 23dBm~30dBm
LTE	Frequency	From Tx : 1710 to 1755 MHz (B4) and from 777 to 787 MHz (B13) From Rx : 2110 to 2155 MHz (B4) and from 746 to 756 MHz (B13)
	Receiving sensitivity	Less than -94 dBm @20M (B4) and less than -94 dBm @10M (B13) (Throughput ≥95%)
	Transmission output	From Power Class3 (B4,B13) 20.3 dBm to 25.7dBm
FCC certification	FCC Identifier	BEJRBHP-B213A
	Model name	IAN2270TNHI
	Certification number	BEJGEN21NA
	Name of the person certified	LG Electronics



OPEN SOURCE SOFTWARE NOTICE

This product contains the open source software detailed below. Please refer to the indicated open source licenses (as are included following this notice) for the terms and conditions of their use.

Open Source	License	Copyright
acl 2.2.52	GPL-2.0 LGPL-2.1	Copyright (C) 1999, 2000 Andreas Gruenbacher, <a.gruenbacher@bestbits.at>
alsa-lib 1.1.2	LGPL-2.1	
alsa-plugins 1.1.0	GPL-2.0 LGPL-2.1	Copyright (C) 2006 Nokia Corporation Copyright (c) 2006 by Takashi Iwai <tiwai@suse.de> Copyright (c) 2009 by Peter Stokes <linux@dadeos.co.uk>
alsa-tools 1.1.3	GPL-2.0	Copyright (C) 2003, Thomas Charbonnel Copyright (c) 2003-2004, Peter Zubaj Copyright (c) 2003, Karsten Wiese Copyright (c) 2004-2007, Rui Nuno Capela
alsa-utils 1.0.29	GPL-2.0	
android-external-f2fs-tools 8.0	LGPL-2.1	
ATK 2.22.0	LGPL-2.1	
attr 2.4.47	GPL-2.0	
AudioManager 6.1	MPL-2.0	Copyright (C) 2012, GENIVI Alliance, Inc. Copyright (C) 2012, BMW AG
base-files 3.0.14	GPL-2.0	
base-passwd 3.5.29	GPL-2.0	
bash 3.2.48	GPL-2.0	Copyright (c) 2007, 2009, 2011, 2014 Free Software Foundation, Inc.



bash-completion 2.4	GPL-2.0	Copyright (c) David Paleino (Debian) Copyright (c) Freddy Vulto Copyright (c) Guillame Rousse (Mandriva) Copyright (c) Igor Murzov Copyright (c) Mike Kelly (Exherbo) Copyright (c) Santiago M. Mola (Exherbo) Copyright (c) Ville Skyttä (Fedora/Red Hat)
beecrypt 4.2.1	LGPL-2.1	Copyright (c) 2004 X-Way Rights BV Copyright (c) 2004 Beeyond Software Holding BV Copyright (c) 2009 Bob Deblrier
bluez 5.43	GPL-2.0 LGPL-2.1	Copyright (c) 2000-2001, Qualcomm Incorporated Copyright (c) 2002-2003, Maxim Krasnyansky <maxk@qualcomm.com> Copyright (c) 2002-2010, Marcel Holtmann <marcel@holtmann.org>
BusyBox 1.23.2	GPL-2.0	
ca-certificates 20161130	GPL-2.0 MPL-2.0	Copyright (c) 2003 Fumitoshi UKAI <ukai@debian.or.jp> Copyright (c) 2009 Philipp Kern <pkern@debian.org> Copyright (c) 2011 Michael Shuler <michael@pbandjelly.org> Copyright (c) Various Debian Contributors Copyright (c) 1994-2000, Netscape Communications Corporation
cairo 1.15.6	MPL-1.1	Copyright (c) 2006 Keith Packard Copyright (c) 2007 Adrian Johnson
Check 0.10.0	LGPL-2.1	Copyright (C) 2001, 2002 Arien Malec
Cinematic Experience 1.0	CC-BY- SA-3.0	-
cmph 2.0	MPL-1.1	
Common API C++ dbus runtime 3.1.12	MPL-2.0	Copyright (c) 2013-2015, Bayerische Motoren Werke Aktiengesellschaft (BMW AG)
CommonAPI runtime 3.1.12	MPL-2.0	Copyright (c) 2013-2015 Bayerische Motoren Werke Aktiengesellschaft (BMW AG)
connman 1.29	GPL-2.0	Copyright (c) 2007-2012 Intel Corporation.



coreutils 6.9	GPL-2.0	
cracklib 2.9.5	LGPL-2.1	Copyright (c) 1993 Alec Muffett <alecm@crypto.dircon.co.uk> Original CrackLib author for releases up to v2.7 Copyright (c) Nathan Neulinger <nneul@neulinger.org> version 3.0 modifications and new release
dlt-daemon 2.16.0	MPL-2.0	Copyright (C) 2011-2015, BMW AG
dosfstools 2.11	GPL-2.0	(c) 2004-2015 Canonical Ltd
e2fsprogs 1.43.4	GPL-2.0 LGPL-2.1	Copyright 1995, 1996, 1997, 1998, 1999, 2000, 2001, 2002, 2003, 2004, 2005, 2006, 2007, 2008, 2009, 2010 by Theodore Ts'o
elfutils 0.170	GPL-2.0	Copyright (c) 1996-2015 Red Hat, Inc. Copyright (c) 2012 Tiler Corporation
evtest	GPL-2.0	
faad2 2.7	GPL-2.0	Copyright (c) 2003-2005 M. Bakker, Nero AG, http://www.nero.com
flac 1.3.1	GPL-2.0 LGPL-2.1	Copyright (C) 2002-2009 Josh Coalson Copyright (C) 2011-2013 Xiph.Org Foundation Copyright (C) 2001 Edmund Grimley Evans <edmund@rano.org> Copyright (C) 2003 Philip Jägenstedt Copyright (C) 2001 David Robinson and Glen Sawyer Copyright (C) 1998-2000 Peter Alm, Mikael Alm, Olle Hallnas, Thomas Nilsson and 4Front Technologies
flashrom 0.9.6.1	GPL-2.0	
gdbm 1.8.3	GPL-2.0	Copyright (C) 1990, 1991, 1993 Free Software Foundation, Inc.



gdk-pixbuf 2.30.8	GPL-2.0 LGPL-2.1	<p>Copyright (C) 1995-1997 Peter Mattis, Spencer Kimball and Josh MacDonald</p> <p>Copyright (C) 1999 The Free Software Foundation</p> <p>Copyright (C) 2000 Red Hat, Inc</p> <p>Copyright (C) 2008 Dominic Lachowicz</p> <p>Copyright (C) 2008 Alberto Ruiz</p> <p>Copyright (C) 2004 Matthias Clasen <mclasen@redhat.com></p> <p>Copyright (C) 2005 Imendio AB</p> <p>Copyright (C) 2001-2002 convergence integrated media GmbH</p> <p>Copyright (C) 2002 convergence GmbH</p> <p>Copyright (C) 2006 Alexander Larsson <alexl@redhat.com></p> <p>Copyright (C) 1998 Cesar Miquel, Shawn T. Amundson, Mattias Grönlund</p> <p>Copyright (C) 2000 Tony Gale</p>
GENIVI Node State Manager (NSM) 2.0.0	MPL-2.0	Copyright (C) 2012 Continental Automotive Systems, Inc
Glib 2.44.1	LGPL-2.1	<p>Copyright (c) 2007-2011 The GNOME Project</p> <p>Copyright (c) 1995-1997 Peter Mattis, Spencer Kimball and Josh MacDonald</p>
glib-networking 2.44.0	LGPL-2.1	<p>Copyright (c) 2010-2011, Collabora Ltd.</p> <p>Copyright (c) 2011-2014, Free Software Foundation</p> <p>Copyright (c) 2011-2014, glib-networking's COPYRIGHT HOLDER</p> <p>Copyright (c) 2006, 2008, Junio C Hamano</p> <p>Copyright (c) 2011, Leandro Regueiro.</p> <p>Copyright (c) 2011-2012, Listed translators</p> <p>Copyright (c) 2009-2013, Red Hat, Inc.</p> <p>Copyright (c) 2010, Stefan Walter</p> <p>Copyright (c) 2011, 2012, Swecha Telugu Localisation team</p> <p>Copyright (c) 2011, The GNOME Project.</p> <p>Copyright (c) 2011, Tommi Vainikainen</p>
glibc 2.25	GPL-2.0 LGPL-2.1	Copyright (C) 1989-2013 Free Software Foundation, Inc.
gmp 6.1.2	GPL-2.0	Copyright (c) 1991-2016, Free Software Foundation, Inc.



GnuTLS 3.3.17	LGPL-2.1	Copyright 2010-2012, Free Software Foundation, Inc.
gst-libav 1.8.3	LGPL-2.1	Copyright (c) 2008 Michael Niedermayer Copyright (c) 2009 Robert Swain (rob opendot cl) Copyright (c) 2002 Jindrich Makovicka Copyright (c) 2011 Stefano Sabatini



<p>gst-plugins-bad 0.10.23</p>	<p>GPL-2.0</p>	<p>Copyright (C) 2010 Thiago Santos <thiago.sousa.santos@collabora.co.uk> Copyright (C) 2009 Carl-Anton Ingmarsson <ca.ingmarsson@gmail.com> Copyright (C) 2010 Ole André Vadla Ravnås <oravnas@cisco.com> Copyright (C) 2007 Alessandro Decina Copyright (C) 2005 Fluendo, S.L. Copyright (C) 2010 Sebastian Dröge <sebastian.droege@collabora.co.uk> Copyright (C) 2005 Ronald S. Bultje <rbultje@ronald.bitfreak.net> Copyright (C) 2008 Nokia Corporation <multimedia@maemo.org> Copyright (c) 1998-2000 Matthew Conte (matt@conte.com) Copyright (C) 2005 Thomas Vander Stichele <thomas@apestaart.org> Copyright (C) <2011> Thibault Saunier <thibault.saunier@collabora.com> Copyright (C) 2011 David Hoyt <dhoit@hoytsoft.org> Copyright (C) 2003 Ronald Bultje <rbultje@ronald.bitfreak.net> Copyright (C) 2010 David Schleef <ds@schleef.org> Copyright (C) <2011> Intel Corporation Copyright (C) <2011> Collabora Ltd. Copyright (C) <2011> Thibault Saunier <thibault.saunier@collabora.com> Copyright (C) <2010> Mark Nauwelaerts <mark.nauwelaerts@collabora.co.uk> Copyright (C) <2010> Collabora Multimedia Copyright (C) <2010> Nokia Corporation Copyright (C) 2005 Michal Benes <michal.benes@itonis.tv> Copyright (C) 2008 Wim Taymans <wim.taymans@gmail.com></p>
------------------------------------	----------------	--------------------------------------------------------------------------------------------------------------------------------------------------------------------------------------------------------------------------------------------------------------------------------------------------------------------------------------------------------------------------------------------------------------------------------------------------------------------------------------------------------------------------------------------------------------------------------------------------------------------------------------------------------------------------------------------------------------------------------------------------------------------------------------------------------------------------------------------------------------------------------------------------------------------------------------------------------------------------------------------------------------------------------------------------------------------------------------------------------------------------------------------------------------------------------------------------------------------------------------------------------------------------------------------------------------------------------------------------------------------------------------------------------------------------------------------------------------------------------------------------------------------------------------------------------------------------------------------------------------------------------------------------------------------------------------------------------------



gst-plugins-bad 1.8.3	LGPL-2.1	Copyright (c) 1994-2014, Free Software Foundation, Inc. Copyright (c) 2012,2015, Matthew Waters Copyright (c) 2008, Filippo Argiolas Copyright (c) 2008-2016, Julien Isorce Copyright (c) 1999, Erik Walthinsen Copyright (c) 2007, Alessandro Decina Copyright (c) 2010, Ole André Vadla Ravnås Copyright (c) 2008-2009, Sebastian Dröge
--------------------------	----------	----------------------------------------------------------------------------------------------------------------------------------------------------------------------------------------------------------------------------------------------------------------------------------------------------------------------------------------------------------------



<p>gst-plugins-base 1.8.3</p>	<p>LGPL-2.1</p>	<p>Copyright (c) Erik Walthinsen <omega@temple-baptist.com></p> <p>Copyright (c) Matt Howell <mhowell@users.sourceforge.net></p> <p>Copyright (c) Brent Bradburn <bbradburn@users.sourceforge.net></p> <p>Copyright (c) Wim Taymans <wim.taymans@gmail.com></p> <p>Copyright (c) Richard Boulton <richard@tartarus.org></p> <p>Copyright (c) Zaheer Abbas Merali <zaheerabbas at merali dot org></p> <p>Copyright (c) David I. Lehn <dlehn@users.sourceforge.net></p> <p>Copyright (c) Chris Emerson <chris@tartarus.org></p> <p>Copyright (c) Jens Thiele <karme@unforgettable.com></p> <p>Copyright (c) Thomas Nyberg <thomas@codefactory.se></p> <p>Copyright (c) Bastien Nocera <hadess@hadess.net></p> <p>Copyright (c) Christian Fredrik Kalager Schaller <Uraeus@linuxrising.org></p> <p>Copyright (c) Thomas Vander Stichele <thomas@apestaart.org></p> <p>Copyright (c) Andy Wingo <wingo@pobox.com></p> <p>Copyright (c) Cameron Hutchison <camh@xdna.net></p> <p>Copyright (c) David Schleef <ds@schleef.org></p> <p>Copyright (c) Benjamin Otte <in7y118@public.uni-hamburg.de></p> <p>Copyright (c) Ronald Bultje <rbultje@ronald.bitfreak.net></p> <p>Copyright (c) Julien MOUTTE <julien@moutte.net></p> <p>Copyright (c) Jan Schmidt <thaytan@mad.scientist.com></p> <p>Copyright (c) Arwed v. Merkatz <v.merkatz@gmx.net></p> <p>Copyright (c) Tim-Philipp Müller <tim at centricular dot net></p> <p>Copyright (c) Mark Borgerding <mark at borgerding dot net> (kissfft, used in libgstfft)</p>
-----------------------------------	-----------------	--------------------------------------------------------------------------------------------------------------------------------------------------------------------------------------------------------------------------------------------------------------------------------------------------------------------------------------------------------------------------------------------------------------------------------------------------------------------------------------------------------------------------------------------------------------------------------------------------------------------------------------------------------------------------------------------------------------------------------------------------------------------------------------------------------------------------------------------------------------------------------------------------------------------------------------------------------------------------------------------------------------------------------------------------------------------------------------------------------------------------------------------------------------------------------------------------------------------------------------------------------------------------------------------------------------------------------------------------------------------------------------------------------------------------------------------------------------------------------------------------------------------------------------------------------------------------------------------------------------------------------------------------------------



gst-plugins-base 0,10,36	LGPL-2.1	<p>Copyright (c) Erik Walthinsen <omega@temple-baptist.com></p> <p>Copyright (c) Matt Howell <mhowell@users.sourceforge.net></p> <p>Copyright (c) Brent Bradburn <bbradburn@users.sourceforge.net></p> <p>Copyright (c) Wim Taymans <wim.taymans@gmail.com></p> <p>Copyright (c) Richard Boulton <richard@tartarus.org></p> <p>Copyright (c) Zaheer Abbas Merali <zaheerabbas at merali dot org></p> <p>Copyright (c) David I. Lehn <dlehn@users.sourceforge.net></p> <p>Copyright (c) Chris Emerson <chris@tartarus.org></p> <p>Copyright (c) Jens Thiele <karme@unforgettable.com></p> <p>Copyright (c) Thomas Nyberg <thomas@codefactory.se></p> <p>Copyright (c) Bastien Nocera <hadess@hadess.net></p> <p>Copyright (c) Christian Fredrik Kalager Schaller <Uraeus@linuxrising.org></p> <p>Copyright (c) Thomas Vander Stichele <thomas@apestaart.org></p> <p>Copyright (c) Andy Wingo <wingo@pobox.com></p> <p>Copyright (c) Cameron Hutchison <camh@xdna.net></p> <p>Copyright (c) David Schleef <ds@schleef.org></p> <p>Copyright (c) Benjamin Otte <in7y118@public.uni-hamburg.de></p> <p>Copyright (c) Ronald Bultje <rbultje@ronald.bitfreak.net></p> <p>Copyright (c) Julien MOUTTE <julien@moutte.net></p> <p>Copyright (c) Jan Schmidt <thaytan@mad.scientist.com></p> <p>Copyright (c) Arwed v. Merkatz <v.merkatz@gmx.net></p> <p>Copyright (c) Tim-Philipp Müller <tim at centricular dot net></p> <p>Copyright (c) Mark Borgerding <mark at borgerding dot net> (kissfft, used in libgstfft)</p>
gst-plugins-good 1.8.3	LGPL-2.1	<p>Copyright (c) 1999, Erik Walthinsen</p> <p>Copyright (c) 1994-2014 Free Software Foundation, Inc</p> <p>Copyright (c) 2005-2007, Wim Taymans</p> <p>Copyright (c) 2003, iOS-Software</p>
gst-plugins-good 0,10,31	LGPL-2.1	<p>Copyright (c) <1999> Erik Walthinsen <omega@cse.ogi.edu></p>



gst-plugins-ugly 1.8.3	LGPL-2.1	Copyright (c) 1994-2014, Free Software Foundation, Inc. Copyright (c) 1999, Erik Walthinsen Copyright (c) 2006 , Tim-Philipp Müller Copyright (c) 2005-2007, Wim Taymans
Gstreamer 0.10.36	LGPL-2.1	Copyright (c) <1999> Erik Walthinsen <omega@cse.ogi.edu>
hostap-utils 0.4.7	GPL-2.0	Copyright (c) 2002-2004, Jouni Malinen <jkmaline@cc.hut.fi>
htop 1.0.3	GPL-2.0	Copyright (c) 2004 - 2016 Hisham Muhammad
i2c-tools 3.1.2	GPL-2.0	
initscripts 1.0	GPL-2.0	



iproute2 4.1.1	GPL-2.0	<p>Copyright (c) 1982, 1986, 1993, The Regents of the University of California.</p> <p>Copyright (c) 2005, 2010-2011, Wind River Systems</p> <p>Copyright (c) 2015, 6WIND S.A.</p> <p>Copyright (c) ~1999, A.N.Kuznetsov</p> <p>Copyright (c) 2013, Cisco Systems, Inc, 2013.</p> <p>Copyright (c) 2011, Czech Technical University in Prague</p> <p>Copyright (c) 2012-2013, Eric Dumazet</p> <p>Copyright (c) 2003-2006, 2014, Ericsson AB</p> <p>Copyright (c) 2011, Felix Fietkau</p> <p>Copyright (c) 2004, Harald Welte</p> <p>Copyright (c) 2008, Intel Corporation.</p> <p>Copyright (c) 2014-2015, Jiri Pirko</p> <p>Copyright (c) 2000-2002, Joakim Axelsson</p> <p>Copyright (c) 2003-2010, Jozsef Kadlecsek</p> <p>Copyright (c) 2011-2012, Kathleen Nichols</p> <p>Copyright (c) 2001-2004, Lubomir Bulej</p> <p>Copyright (c) 1999-2000, Maxim Krasnyansky</p> <p>Copyright (c) 2012, Michael D. Taht</p> <p>Copyright (c) 1999, Pavel Golubev</p> <p>Copyright (c) 2011-2014, PLUMgrid, http</p> <p>Copyright (c) 2001, Robert Olsson</p> <p>Copyright (c) 2013, Terry Lam</p> <p>Copyright (c) 2004-2007, USAGI/WIDE Project</p> <p>Copyright (c) 2011-2012, Van Jacobson</p> <p>Copyright (c) 2002-2007, Volkswagen Group Electronic Research</p> <p>Copyright (c) 2009, Wolfgang Grandegger</p> <p>Copyright (c) Patrick McHardy</p>
iptables 1.4.21	GPL-2.0	



kbd 2.0,2	GPL-2.0	<p>Copyright (C) 1992 Rickard E. Faith, Copyright (C) 1993 Risto Kankkunen, Copyright (C) 1993 Eugene G. Crosser, Copyright (C) 1994 H. Peter Anvin, Copyright (C) 1994-1999 Andries E. Brouwer, Copyright (C) 1994 by Jon Tombs <jon@gtex02.us.es> portions also authors: Andries E. Brouwer <aeb@cwil.nl> Joshua Spoerri <josh@cooper.edu> Chuck Martin <cmartin@bigfoot.com> Alexey Gladkov <gladkov.alexey@gmail.com> Copyright (C) 2011 Alexey Gladkov, Copyright (C) 2011 Alexey Gladkov, portions also Copyright (C) 2011 Canonical Ltd. Authors: Seth Forshee <seth.forshee@canonical.com> Dustin Kirkland <kirkland@canonical.com> Copyright (C) 1994-1998 Michael K. Johnson <johnsonm@redhat.com> Copyright (C) 2002-2006 Dmitry V. Levin <ldv@altlinux.org></p>
libcgroup 0.41	LGPL-2.1	
libcroco 0.6.8	LGPL-2.1	
libdaemon 0.14	LGPL-2.1	
libebml 1.3.4	LGPL-2.1	
libevdev 1.4.2	GPL-2.0	Copyright (c) 1999-2002, Vojtech Pavlik
libfuse 2.9.7	GPL-2.0 LGPL-2.1	
libgcrypt 1.7.3	GPL-2.0 LGPL-2.1	Copyright (c) 2000, 2001, 2002 Free Software Foundation, Inc.
libgpg-error 1.19	GPL-2.0 LGPL-2.1	Copyright (c) 2003-2007, 2013-2015 g10 Code GmbH Copyright (c) 1994-2013 Free Software Foundation, Inc.
libgudev 230	LGPL-2.1	Copyright (c) 2008 David Zeuthen <davidz@redhat.com> Copyright (c) 1999-2014 Free Software Foundation, Inc.



libical 2.0.0	MPL-1.1	Copyright (c) 2000, Eric Busboom <eric@softwarestudio.org> Copyright (c) 2015 William Yu <williamyu@gnome.org> Copyright (c) 2002, Critical Path Copyright (c) 2001, Patrick Lewis <plewis@inetarena.com>
libid3tag 0.15.1	GPL-2.0	Copyright (c) 2000-2004 Underbit Technologies, Inc.
libmatroska 1.4.5	LGPL-2.1	Copyright (C) 2002-2010 Steve Lhomme.
libnl 3.2.25	LGPL-2.1	Copyright (c) 2003-2010 Thomas Graf <tgraf@suug.ch>
libproxy 0.4.11	LGPL-2.1	
libsvg 2.40.18	LGPL-2.1	Copyright (c) 2000, Eazel, Inc. Copyright (c) 2002, Dom Lachowicz <cinamod@hotmail.com> Copyright (c) 2006, Yangli Hector Yee Copyright (c) 2003, 2004, 2005, Caleb Moore <c.moore@student.unsw.edu.au> Copyright (c) 2002, 2003, 2004, 2005, Dom Lachowicz <cinamod@hotmail.com> Copyright (c) 1994-2013, Free Software Foundation, Inc.
libsndfile 1.0.28	LGPL-2.1	Copyright (c) 1999-2017, Erik de Castro Lopo Copyright (c) 1992, Jutta Degener and Carsten Bormann, Technische Copyright (c) 2011, Apple Inc. Copyright (c) 1994-2016 Free Software Foundation, Inc.
libsoup 2.50.0	LGPL-2.1	Copyright (c) 2007-2012, Red Hat, Inc. Copyright (c) 2000-2003, Ximian, Inc. Copyright (c) 2005, 2007 Novell, Inc. Copyright (c) 2009-2010, 2012, Igalia S.L. Copyright (c) 2009, 2011-2012, Collabora Ltd.
libusb 1.0.20	LGPL-2.1	Copyright (c) 2001 Johannes Erdfelt Copyright (c) 2007-2009 Daniel Drake Copyright (c) 2008-2011 Nathan Hjelm Copyright (c) 2009-2012 Pete Batard Copyright (c) 2010-2012 Michael Plante Copyright (c) 2011-2012 Hans de Goede Copyright (c) 2012 Martin Pieuchot



libusb-compat 0.1.5	BSD-3- Clause LGPL-2.1	Copyright (c) 2000-2003 Johannes Erdfelt <johannes@erdfelt.com>
libuser 0.62	LGPL-2.1	Copyright (c) 2001, 2002, 2004 Red Hat, Inc.
libwebsockets 2.1	LGPL-2.1	Copyright (c) 2010, "Cowboy" Ben Alman Copyright (c) 1987, 1993-1994, 1996 The Regents of the University of California. Copyright (c) 1995-1998, WIDE Project. Copyright (c) 1995-2005, 2010 Jean-loup Gailly. Copyright (c) 2016 Alexander Bruines <alexander.bruines@gmail.com> Copyright (c) 2010-2016 Andy Green <andy@warmcat.com> Copyright (c) 2001 Bob Trower, Trantor Standard Systems Inc. Copyright (c) Kitware Inc. Copyright (c) 1995-2010 Jean-loup Gailly and Mark Adler Copyright (c) 2011, John Resig Copyright (c) 2000-2001 Kungliga Tekniska Hgskolan Copyright (c) 1995-2010 Mark Adler Copyright (c) 2013 Steven Benner (http://stevenbenner.com/). Copyright (c) 2012 Tatsuhiro Tsujikawa Copyright (c) 2011, The Dojo Foundation
Linux Kernel 4.1.27	GPL-2.0	
Linux-PAM 1.2.1	GPL-2.0	Copyright (C) YEAR Linux-PAM Project Copyright (c) 2005, 2006 Thorsten Kukuk <kukuk@suse.de>
lzo 2.09	GPL-2.0	Copyright (C) 1996 - 2015 Markus F.X.J. Oberhumer
mmc-utils 0.1	GPL-2.0	Copyright (c) 2016 SanDisk Corp
mp4v2 2.0.0	MPL-1.1	Copyright (C) Cisco Systems Inc. 2001. Copyright (C) Ximpo Group Ltd. 2003, 2004. Copyright (C) 2008 Kona Blend.
MPEG audio decoder library 0.15.1b	GPL-2.0	Copyright (C) 2000-2004 Underbit Technologies, Inc.



mtd-utils 1.5.1	GPL-2.0	
neard 0.15	GPL-2.0	Copyright (C) 2011 Intel Corporation. Copyright (C) 2004-2010 Marcel Holtmann <marcel@holtmann.org>
neon 0.30.1	LGPL-2.1	Copyright (c) 1999-2008 Joe Orton <joe@manyfish.co.uk> Portions are: Copyright (c) Aleix Conchillo Flaque <aleix@member.fsf.org> Copyright (c) Arfrever Frehtes Taifersar Arahesis Copyright (c) Arun Garg <arung@pspl.co.in> Copyright (c) Daniel Stenberg <daniel@haxx.se> Copyright (c) Free Software Foundation, Inc. Copyright (c) Henrik Holst <henrik.holst2@gmail.com> Copyright (c) Jiang Lei <tristone@deluxe.ocn.ne.jp> Copyright (c) Kai Sommerfeld <kso@openoffice.org> Copyright (c) Karl Ove Hufthammer, Copyright (c) Michael Sobolev Copyright (c) Nobuyuki Tsuchimura <tutumura@nn.iij4u.or.jp> Copyright (c) Sylvain Glaize <mokona@puupuu.org> Copyright (c) Thomas Schultz <tststs@gmx.de> Copyright (c) Vladimir Berezniker @ http://public.xdi.org/=vmpn Copyright (c) Yves Martin <ymartin59@free.fr>
netbase 5.4	GPL-2.0	Copyright (c) 1994-2010, Peter Tobias, Anthony Towns and Marco d'Itri
nettle 2.7.1	GPL-2.0 LGPL-2.1	
ofono 1.16	GPL-2.0	Copyright (C) 2008-2011 Intel Corporation.
opkg-utils 0.3.4	GPL-2.0	Copyright (c) 2006-2007, Paul Sokolovsky
pango 1.36.8	LGPL-2.1	Copyright (c) 1999 Red Hat Software
pciutils 3.3.1	GPL-2.0	Copyright (c) 1997-2015, Martin Mares
persistence-administrator 7.0	MPL-2.0	Copyright (c) 2012, Continental Automotive Systems, Inc.
persistence-client-library 7.0	MIT MPL-2.0	Copyright (c) 2016 Mentor Graphics. copyright (c) 2012 Company XS Embedded GmbH



persistence-common-object 7,0	MPL-2.0	Copyright (c) 2012-2013 Continental Automotive Systems, Inc.
procps-ng 3.3.10	GPL-2.0 LGPL-2.1	
psmisc 22.21	GPL-2.0	
PyGObject 2.28.3	LGPL-2.1	Copyright (c) James Henstridge <james@daa.com.au> Copyright (c) Johan Dahlin <johan@gnome.org> Copyright (c) Gustavo J A M Carneiro <gjc@gnome.org> Copyright (c) Paul Pogonyshev <pogonyshev@gmx.net> Copyright (c) Gian Mario Tagliaretti <gianmt@gnome.org> Copyright (c) Tomeu Vizoso <tomeu.vizoso@collabora.co.uk>
python-pygobject 2,28,3	LGPL-2.1	
QT 5.4.1	LGPL-2.1	Copyright (C) 2014 Digia Plc and/or its subsidiary(-ies).
quota 4.03	GPL-2.0	Copyright (c) 2007 SUSE CR Copyright (c) 2000 Silicon Graphics, Inc.
rpm 5.4.14	GPL-2.0 LGPL-2.1	
sbc 1.3	GPL-2.0 LGPL-2.1	Copyright (c) 2008-2010 Nokia Corporation Copyright (c) 2004-2010 Marcel Holtmann <marcel@holtmann.org> Copyright (c) 2004-2005 Henryk Ploetz <henryk@ploetzli.ch> Copyright (c) 2005-2008 Brad Midgley <bmidgley@xmission.com>
shadow 4,5	GPL-2.0	Copyright (c) 2007 - 2011, Nicolas François Copyright (c) 1989 - 1994, Julianne Frances Haugh Copyright (c) 1991 - 1993, Chip Rosenthal Copyright (c) 1996 - 2000, Marek Michałkiewicz Copyright (c) 2001 - 2007, Tomasz Kłoczko
shared-mime-info 1,8	GPL-2.0	



Socat 1.7.3.0	GNU General Public License v2.0 w/ socat OpenSSL Exception	Copyright (c) 2001-2011, Gerhard Rieger and contributors
stat 3.3	GPL-1.0	Copyright (c) 1996-2001, Michael Meskes
sysfsutils 2.1.0	GPL-2.0 LGPL-2.1	Copyright (c) Ananth Mavinakayanahalli Copyright (c) Daniel Stekloff Copyright (c) Mohan Kumar Copyright (c) Nitin Vashisth Copyright (c) Ananth Mavinakayanahalli Copyright (c) Daniel Stekloff Copyright (c) Mohan Kumar Copyright (c) Nitin Vashisth Copyright (c) Ananth Mavinakayanahalli Copyright (c) Daniel Stekloff Copyright (c) Mohan Kumar Copyright (c) Nitin Vashisth
systemd 225	GPL-2.0 LGPL-2.1	Copyright (c) 2010 Lennart Poettering
taglib 1.9.1	MPL-1.1	
tar 1.17	GPL-2.0	
time 1.7	GPL-2.0	
tree 1.7.0	GPL-2.0	
usbutils 008	GPL-2.0	Copyright (c) Thomas Sailer, <t.sailer@alumni.ethz.ch> Copyright (c) Johannes Erdfelt Copyright (c) David Brownell Copyright (c) Aurelien Jarno



Util-Linux 2.26.2	GPL-2.0	Copyright (C) 1989, 1991 Free Software Foundation, Inc. Copyright (C) 2007 Karel Zak <kzak@redhat.com> Copyright (C) 1999 by Andries Brouwer Copyright (C) 1999, 2000, 2003 by Theodore Ts'o Copyright (C) 2001 by Andreas Dilger Copyright (C) 2004 Kay Sievers <kay.sievers@vrfy.org> Copyright (C) 2008-2013 Karel Zak <kzak@redhat.com>
v4l-utils 1.6.2	GPL-2.0 LGPL-2.1	Copyright (c) 1989, 1991 Free Software Foundation, Inc.,
vCard/vCal Parser C Library	MPL-1.1	
which 2.18	GPL-2.0	Copyright (c) 1987-1997, Free Software Foundation, Inc. Copyright (c) 1999-2007, Carlo Wood
Wireless Tools 30	GPL-2.0	Copyright (c) 1996-2008 Jean Tourrilhes
XZ Utils 5.2.3	GPL-2.0 LGPL-2.1	



The source code for the above may be obtained free of charge at <http://opensource.lge.com>. We will also provide open source code to you on CD-ROM for a charge covering the cost of performing such distribution (such as the cost of media, shipping, and handling) upon email request to opensource@lge.com. This offer is valid for a period of three years after our last shipment of this product. This offer is valid to anyone in receipt of this information.

Please be informed that this product may contain open source software listed in to tables below.

Open Source	License	Copyright
Aladdin Enterprises MD5 implementation	Zlib	Copyright (C) 1999 Aladdin Enterprises. L. Peter Deutsch ghost@aladdin.com
alsa-state 0.2.0	MIT	
Android Open Source Project 4.4	Apache-2.0	
android-bionic-libc	BSD-2-Clause BSD-3-Clause	Copyright 1997 Niels Provos < provos@physnet.uni-hamburg.de > Copyright 2008 Damien Miller < djm@openbsd.org > Copyright (c) 2013 David Chisnall Copyright (c) 2014, NVIDIA Corporation Copyright (c) 2012-2015 Linaro Limited Copyright (c) 2012 Stephen Montgomery-Smith < stephen@freebsd.org > Copyright (c) 2004 Stefan Farfeleder Copyright (c) 2003-2007, Steven G. Kargl Copyright (c) 2002 Daniel Hartmeier Copyright (c) 2000-2013 The NetBSD Foundation, Inc Copyright (c) 1997, 1998, 1999, 2004 The NetBSD Foundation, Inc Copyright (C) 2006-2017 The Android Open Source Project Copyright (c) 2013-2014 NVIDIA Corporation Copyright (c) 1997 Niklas Hallqvist Copyright (c) 2001-2002 Opsycon AB (www.opsycon.se / www.opsycon.com) Copyright (c) 2001-2011 The FreeBSD Project Copyright (c) 2002-2005 Tim J. Robbins



android-bionic-libc	BSD-2-Clause BSD-3-Clause	<p>Copyright (c) 2002-2009 The NetBSD Foundation, Inc</p> <p>Copyright (c) 2003-2011 David Schultz <das@freebsd.org></p> <p>Copyright (c) 2003 Mike Barcroft <mike@freebsd.org></p> <p>Copyright (c) 2003 Networks Associates Technology, Inc</p> <p>Copyright (c) 2005-2013 Bruce D. Evans and Steven G. Kargl</p> <p>Copyright (c) 2011 David Chisnall</p> <p>Copyright (c) 2011 Ed Schouten <ed@freebsd.org></p> <p>Copyright (c) 2011 David Chisnall <theraven@freebsd.org></p> <p>Copyright (c) 2015 Joerg Sonnenberger <joerg@netbsd.org></p> <p>Copyright (c) 1999-2003 Citrus Project</p> <p>Copyright(C) 1995, Jason Downs</p> <p>Copyright (c) 1997 Todd C. Miller <todd.miller@courtesan.com></p> <p>Copyright (c) 2014, Linaro Limited</p> <p>Copyright (c) 2014, ARM Limited</p> <p>Copyright (c) 2014, Linaro Ltd</p> <p>Copyright (c) 1993 John Brezak</p> <p>Copyright (c) 1993 John Brezak</p> <p>Copyright (c) 2009-2013 The Linux Foundation</p> <p>Copyright (C) 1995, 1996, 1997, and 1998 WIDE Project</p> <p>Copyright (C) 2010-2011 The Android Open Source Project</p> <p>Copyright (c) 2008 ARM Ltd</p> <p>Copyright (c) 1982-1993 The Regents of the University of California</p> <p>Copyright (c) UNIX System Laboratories, Inc</p> <p>Copyright (c) 1994 SigmaSoft, Th. Lockert <tholo@sigmasoft.com></p> <p>Copyright (c) 1998 Todd C. Miller <todd.miller@courtesan.com></p> <p>Copyright (c) 1999 David E. O'Brien</p>
---------------------	------------------------------	--------------------------------------------------------------------------------------------------------------------------------------------------------------------------------------------------------------------------------------------------------------------------------------------------------------------------------------------------------------------------------------------------------------------------------------------------------------------------------------------------------------------------------------------------------------------------------------------------------------------------------------------------------------------------------------------------------------------------------------------------------------------------------------------------------------------------------------------------------------------------------------------------------------------------------------------------------------------------------------------------------------------------------------------------------------------------------------------------------------------------------------------------------------------------------------------------------------------------------------------------------------------------------------------------------------------------------------------------------------------------------------------------------------------------------------------------------------------------------------------------------



android-bionic-libc	BSD-2-Clause BSD-3-Clause	<p>Copyright (c) 2000 Ben Harris</p> <p>Copyright (C) 1995, 1996, 1997, and 1998 WIDE Project</p> <p>Copyright (c) 2001-2002 Opsycon AB (www.opsycon.se / www.opsycon.com)</p> <p>Copyright (c) 2003 Constantin S. Svintsoff <kostik@iclub.nsu.ru></p> <p>Copyright (c) 2003 Dag-Erling Smørgrav</p> <p>Copyright (c) 2010 MIPS Technologies, Inc</p> <p>Copyright (c) 2008-2015 ARM Ltd</p> <p>Copyright (c) 2010, 2011, 2012, 2013 Intel Corporation</p> <p>Copyright (c) 2011, VMware, Inc</p> <p>Copyright (c) 2012-2014, Linaro Limited</p> <p>Copyright (c) 2012-2015 MIPS Technologies, Inc., California</p> <p>Copyright (c) 2013 MIPS Technologies, Inc., California</p> <p>Copyright (c) 2013 ARM Ltd</p> <p>Copyright (c) 2013-2014, NVIDIA Corporation</p> <p>Copyright (c) Johnny Qiu <joqiu@nvidia.com></p> <p>Copyright (c) 2014 Imagination Technologies Limited</p> <p>Copyright (c) Shu Zhang <chazhang@nvidia.com></p> <p>Copyright (c) 2014, Intel Corporation</p> <p>Copyright (c) 2014, ARM Limited</p> <p>Copyright (c) 2014, Linaro Ltd</p>
android-external-tremor 20150107	BSD-3-Clause	Copyright (c) 1994-2002, Xiph.org Foundation
android-external-wpa_supplicant_8	BSD-3-Clause	Copyright (c) 2002-2017, Jouni Malinen <j@w1.fi> and contributors
Android-hardware-qcom	BSD-3-Clause	
android-system-core 4.4.2	Apache-2.0 BSD-2-Clause BSD-3-Clause BSD-like License (android-system-core-toolbox)	Copyright (C) 2010 The Android Open Source Project



android-system-core-rootdir 4.4.2	Apache-2.0	Copyright (c) 2007-2011 The Android Open Source Project
Anti-Grain Geometry 2.4	Anti-Grain Geometry Public License	Copyright (C) 2002-2005 Maxim Shemanarev (http://www.antigrain.com)
apr 1.5.2	Apache-2.0	
apr	Apache-2.0	
apr-util 1.5.4	Apache-2.0	Copyright (c) 2008-2016, The Apache Software Foundation
Bitstream Vera Fonts 1.10	Bitstream Vera License	Copyright (c) 2003 Bitstream, Inc.
Boost 1.58.0	BSL-1.0	Copyright (c) 1998-2005 Beman Dawes, David Abrahams. Copyright (c) 2004-2007 Rene Rivera. Copyright (c) 2001-2011 Joel de Guzman Copyright (c) 2003-2015 Christopher M. Kohlhoff (chris at kohlhoff dot com) Copyright (c) Aleksey Gurtovoy 2000-2004
bzip2 1.0.6	bzip2-1.0.6	
Cantarell Fonts	OFL-1.1	Copyright (c) 2009--2016, The Cantarell Authors
chunjiin	MIT	Copyright (c) 2016 kys-zeda
Class-ISA 0.36	Artistic-1.0-Perl	Copyright (c) 1999-2009, Sean M. Burke.
codeaurora-platform-vendor-qcom-opensource-dataservices	BSD-3-Clause	Copyright (c) 2013-2015, The Linux Foundation.
codeaurora-platform-vendor-qcom-opensource-mm-audio	BSD-3-Clause	Copyright (c) 2014-2016, The Linux Foundation Copyright (c) 2008-2009, Luis R. Rodriguez
codeaurora-platform-vendor-qcom-opensource-shortcut-fe	MIT	Copyright (c) 2013-2015 The Linux Foundation.



codeaurora- quic-la-platform- vendor-qcom- opensource-data- ipa-cfg-mgr	BSD-3-Clause	Copyright (c) 2013-2016, The Linux Foundation.
Convert-ASN1 0.27	Artistic-1.0	Copyright (c) 2014 by Graham Barr.
cpp-base64	Zlib	Copyright (c) 2004-2017 by René Nyffenegger
cronie 1.5.1	BSD-2-Clause BSD-3-Clause ISC	Copyright (c) 1988, 1993, 1994, The Regents of the University of California. Copyright (c) 1989, 1993, The Regents of the University of California. Copyright (c) 2004, Internet Systems Consortium, Inc. ("ISC") Copyright (c) 1997,2000, Internet Software Consortium, Inc.
curl 7.54.0	curl	Copyright (c) 1996 - 2017, Daniel Stenberg, <daniel@haxx.se>.
Date Time 2.30	Artistic-1.0	Copyright (c) 1995-2009, Graham Barr.
dawgdic 0.4.3	BSD-3-Clause	Copyright (c) 2009-2012, Susumu Yata



dbus 1.8.20	AFL-2.1	<p>Copyright (c) 1992-2014 Free Software Foundation, Inc.</p> <p>Copyright (c) 2003 Philip Blundell</p> <p>Copyright (c) 2003-2006 Red Hat, Inc.</p> <p>Copyright (c) 2006 Thiago Macieira</p> <p>Copyright (c) 2008-2012 Nokia Corporation</p> <p>Copyright (c) 2008-2013 Collabora Ltd.</p> <p>Copyright (c) 2002 Michael Meeks</p> <p>Copyright (c) 1994 X Consortium</p> <p>Copyright (c) 2005, 2010 Lennart Poettering</p> <p>Copyright (c) 2002, 2003 CodeFactory AB</p> <p>Copyright (c) 2005 Novell, Inc.</p> <p>Copyright (c) 2009 Klaralvdalens Datakonsult AB, a KDAB Group company, info@kdab.net</p> <p>Copyright (c) 2007, Tanner Lovelace</p> <p>Copyright (c) 2008, Colin Walters</p> <p>Copyright (c) 2008-2009, Benjamin Reed</p> <p>Copyright (c) 2013 Intel Corporation</p> <p>Copyright (c) 2000 Werner Almesberger</p> <p>Copyright (c) 1991-1993 The Regents of the University of California.</p> <p>Copyright (c) 1994 Sun Microsystems, Inc.</p> <p>Copyright (c) 2006 Christian Ehrlicher</p> <p>Copyright (c) 2005 g10 Code GmbH</p> <p>Copyright (c) 1995 A. M. Kuchling</p> <p>Copyright (c) 2006-2013 Ralf Habacker</p> <p>Copyright (c) 2004 Eric Poech</p> <p>Copyright (c) 2004 Robert Shearman</p> <p>Copyright (c) 2004 Imendio HB</p> <p>Copyright (c) 2009 Yaakov Selkowitz</p> <p>Copyright (c) 2008 Laurent Montel,</p> <p>Copyright (c) 2011, Raphael Kubo da Costa</p> <p>Copyright (c) 2006, Tim Beaulen</p> <p>Copyright (c) 2004-2005 Scott James Remnant</p>
-------------	---------	-----------------------------------------------------------------------------------------------------------------------------------------------------------------------------------------------------------------------------------------------------------------------------------------------------------------------------------------------------------------------------------------------------------------------------------------------------------------------------------------------------------------------------------------------------------------------------------------------------------------------------------------------------------------------------------------------------------------------------------------------------------------------------------------------------------------------------------------------------------------------------------------------------------------------------------------------------------------------------------------------------------------------------------------------------------------------------------------------------------------------------------------------------------------------------------------------------------------------------------------------------------------------------------------------------------------------------------------------------------------------------------------------------------------------------------------------------------------------------------------------------------



dbus-glib 0.104	AFL-2.1	Copyright (c) 1992-2014 Free Software Foundation, Inc. Copyright (c) 1994 X Consortium Copyright (c) 2002, 2003 CodeFactory AB Copyright (c) 2002-2005 Red Hat Inc. Copyright (c) 2003-2004 Lawrence E. Rosen. All rights reserved. Copyright (c) 2004 Scott James Remnant Copyright (c) 2004 Ximian, Inc. Copyright (c) 2005-2011 Nokia Corporation Copyright (c) 2007 Codethink Ltd.
dri2proto 2.8	MIT-like License (dri2proto)	Copyright (c) 2007 Red Hat, Inc.
dropbear 2015.68	MIT	Copyright (c) 2002-2014, Matt Johnston Copyright (c) 2004, Mihnea Stoenescu
Dumpvalue 1.17	Artistic-1.0-Perl	Copyright (c) 2012, Ilya Zakharevich.
e2fsprogs 1.43.4	MIT-like License (e2fsprogs)	Copyright 1995, 1996, 1997, 1998, 1999, 2000, 2001, 2002, 2003, 2004, 2005, 2006, 2007, 2008, 2009, 2010 by Theodore Ts'o
EasyLoggingPP	MIT	Copyright (c) 2012-2018 Muflihun Labs Copyright (c) 2012-2018 @abumusamq
Env 1.04	Artistic-1.0-Perl	Copyright (c) 2013, Chip Salzenberg.
expat 2.2.3	MIT	Copyright (c) 1998-2000 Thai Open Source Software Center Ltd and Clark Cooper Copyright (c) 2001-2017 Expat maintainers
file 5.24	BSD-like License (file)	Copyright (c) Ian F. Darwin 1986, 1987, 1989, 1990, 1991, 1992, 1994, 1995, Ian F. Darwin and others
File-CheckTree 4.41	Artistic-1.0-Perl	Copyright (c) 2011, Larry Wall.



flac 1.3.1	BSD-3-Clause	<p>Copyright (C) 2002-2009 Josh Coalson</p> <p>Copyright (C) 2011-2013 Xiph.Org Foundation</p> <p>Copyright (C) 2001 Edmund Grimley Evans <edmund@rano.org></p> <p>Copyright (C) 2003 Philip Jägenstedt</p> <p>Copyright (C) 2001 David Robinson and Glen Sawyer</p> <p>Copyright (C) 1998-2000 Peter Alm, Mikael Alm, Olle Hallnas, Thomas Nilsson and 4Front Technologies</p>
fontconfig 2.12.1	MIT-like License (fontconfig)	<p>Copyright (c) 2000,2001,2002,2003,2004,2006,2007 Keith Packard</p> <p>Copyright (c) 2005 Patrick Lam</p> <p>Copyright (c) 2009 Roozbeh Pournader</p> <p>Copyright (c) 2008,2009 Red Hat, Inc.</p> <p>Copyright (c) 2008 Danilo Šegan</p> <p>Copyright (c) 2012 Google, Inc.</p>
freetype 2.6	FTL	Copyright (c) 2006-2015 by David Turner, Robert Wilhelm, and Werner Lemberg.
fts	BSD-4-Clause	Copyright (c) 1990, 1993, 1994, The Regents of the University of California.
GeoMetric Tools Engine 3.12	BSL-1.0	Copyright (c) 1998-2018, David Eberly, Geometric Tools, Redmond WA 98052
Google C++ Mocking Framework	BSD-3-Clause	Copyright (c) 2008, Google Inc.
googletest 1.7.0	BSD-3-Clause	Copyright (c) 2008, Google Inc.
googletest	BSD-3-Clause	Copyright (c) 2008, Google Inc.



HarfBuzz 1.4.8	MIT-like License (HarfBuzz)	<p>Copyright (c) 2010-2012, Google, Inc.</p> <p>Copyright (c) 2012, Mozilla Foundation</p> <p>Copyright (c) 2011, Codethink Limited</p> <p>Copyright (c) 2008, 2010, Nokia Corporation and/or its subsidiary(-ies)</p> <p>Copyright (c) 2009, Keith Stribley</p> <p>Copyright (c) 2009, Martin Hosken and SIL International</p> <p>Copyright (c) 2007, Chris Wilson</p> <p>Copyright (c) 2006, Behdad Esfahbod</p> <p>Copyright (c) 2005, David Turner</p> <p>Copyright (c) 2004, 2007-2010, Red Hat, Inc.</p> <p>Copyright (c) 1998-2004, David Turner and Werner Lemberg</p>
hdparm 9.48	BSD-3-Clause	<p>Copyright (c) The Regents of the University of California</p> <p>Copyright (c) 2009 Jan Friesse <jfriesse@gmail.com></p> <p>Copyright (c) 1994-2008 Mark Lord</p> <p>Copyright (c) 1994-2008 Mark Lord</p>
l18n-Collate 1.02	Artistic-1.0-Perl	Copyright (c) 2011, Jarkko Hietaniemi.
icu 55.1	ICU	Copyright (c) 1995-2010 International Business Machines Corporation and others
Info-ZIP 3.0	Info-ZIP	Copyright (c) 1990-2007 Info-ZIP
inih	BSD-3-Clause	Copyright (c) 2009, Ben Hoyt
iperf 2.0.5	NCSA	Copyright (c) 1999-2007, The Board of Trustees of the University of Illinois
Irrlicht Engine SDK 1.0	Zlib	Copyright (C) 2002-2007 Nikolaus Gebhardt
iw 4.1	ISC	<p>Copyright (c) 2007, 2008, Johannes Berg</p> <p>Copyright (c) 2007, Andy Lutomirski</p> <p>Copyright (c) 2007, Mike Kershaw</p> <p>Copyright (c) 2008-2009, Luis R. Rodriguez</p>
jpeg 9a	IJG	<p>Copyright (c) 1991-1994, Thomas G. Lane.</p> <p>Copyright (c) 1989, 2000 Aladdin Enterprises.</p>



json-c 0.12	MIT	Copyright (c) 2009-2012 Eric Haszlakiewicz Copyright (c) 2004, 2005 Metaparadigm Pte Ltd
JsonCPP 1.7.0	MIT	Copyright (c) 2007-2010 Baptiste Lepilleur
Kazlib	MIT-like License (Kazlib)	Copyright (c) 1999-2012, Kaz Kylheku
less 487	Less	Copyright (c) 1984-2016 Mark Nudelman
libarchive 3.3.1	BSD-2-Clause	Copyright (c) 2003-2009 Tim Kientzle
libbsd 0.8.3	BSD-2-Clause BSD-3-Clause ISC MIT	Copyright (c) 1994, 1997-2000, 2002, 2008, The NetBSD Foundation, Inc. Copyright (c) 1998, M. Warner Losh Copyright (c) 1997, Christos Zoulas. Copyright (c) 2001, Dima Dorfman. Copyright (c) 2001, FreeBSD Inc. Copyright (c) 2002, Niels Provos Copyright (c) 2002, Thomas Moestl Copyright (c) 2005, Colin Percival Copyright (c) 2005, Pawel Jakub Dawidek Copyright (c) 2007, Dag-Erling Coïdan Smørgrav Copyright (c) 2007, Dag-Erling Coïdan Smørgrav Copyright (c) 2007, Eric Anderson Copyright (c) 2007, Pawel Jakub Dawidek Copyright (c) 2009, Advanced Computing Technologies LLC Copyright (c) 2011, Guillem Jover



libbsd 0.8.3	BSD-2-Clause BSD-3-Clause ISC MIT	<p>Copyright (c) 2004-2006, 2008-2015, Guillem Jover</p> <p>Copyright (c) 2005, Hector Garcia Alvarez</p> <p>Copyright (c) 2005, Aurelien Jarno</p> <p>Copyright (c) 2006, Robert Millan</p> <p>Copyright (c) 1980, 1982, 1986, 1989-1994, The Regents of the University of California.</p> <p>Copyright (c) 2001, Mike Barcroft</p> <p>Copyright (c) UNIX System Laboratories, Inc.</p> <p>Copyright (c) 1995-1996, Peter Wemm</p> <p>Copyright (c) 2002, Networks Associates Technology, Inc.</p> <p>Copyright (c) 2004, Ted Unangst and Todd Miller</p> <p>Copyright (c) 1996, David Mazieres</p> <p>Copyright (c) 1998, 2000-2002, 2004-2005, 2007, 2010, 2012-2014, Todd C. Miller</p> <p>Copyright (c) 2008, Damien Miller</p> <p>Copyright (c) 2008, Otto Moerbeek</p> <p>Copyright (c) 2013, Markus Friedl</p> <p>Copyright (c) 2014, Bob Beck</p> <p>Copyright (c) 2014, Brent Cook</p> <p>Copyright (c) 2014, Theo de Raadt</p> <p>Copyright (c) 2015, Michael Felt</p> <p>Copyright (c) 2015, Guillem Jover</p> <p>Copyright (c) 2010, William Ahern</p> <p>Copyright (c) 2012, Guillem Jover</p>
libdrm 2.4.67	MIT	<p>Copyright (c) 2009 VMware, Inc., Palo Alto, CA., USA</p> <p>Copyright (C) 2013 Rob Clark <robclark@freedesktop.org></p> <p>Copyright 2012 Red Hat Inc.</p> <p>Copyright (c) 2014 NVIDIA Corporation</p> <p>Copyright 2014 Advanced Micro Devices, Inc.</p> <p>Copyright 2008 Tungsten Graphics Jakob Bornecrantz <jakob@tungstengraphics.com></p> <p>Copyright 2008 Intel Corporation Jesse Barnes <jesse.barnes@intel.com></p>
libepoxy 1.4.0	MIT	<p>Copyright (c) 2013-2014, Intel Corporation</p> <p>Copyright (c) 2013, The Khronos Group Inc.</p>



libevent 1.4.2	MIT	Copyright (c) 2013, Red Hat, Inc. Copyright (c) 2013, David Herrmann
libevent 2.0.22	BSD-3-Clause MIT-like License (OpenBSD)	Copyright (c) 2000-2007 Niels Provos <provos@citi.umich.edu> Copyright (c) 2007-2012 Niels Provos and Nick Mathewson Copyright (c) 2000 Dug Song <dugsong@monkey.org> Copyright (c) 1993 The Regents of the University of California. Copyright (c) 1998 Todd C. Miller <todd.miller@courtesan.com> Copyright (c) 2003 Michael A. Davis <mike@datanerds.net> Copyright (c) 2007 Sun Microsystems Copyright (c) 2002 Christopher Clark Copyright (c) 2006 Maxim Yegorushkin <maxim.yegorushkin@gmail.com> Copyright (c) 1996, David Mazieres <dm@uun.org> Copyright (c) 2008, Damien Miller <djm@openbsd.org>
libffi 3.2.1	MIT	Copyright (c) 1996-2012 Anthony Green, Red Hat, Inc and others.
libfixmatrix	MIT	Copyright (c) 2011-2012 Petteri Aimonen <jpa at fixmatrix.mail.kapsi.fi>
libglu 9.0.0	MIT	Copyright (c) 1991-2000, Silicon Graphics, Inc.
libinput 0.15.0	MIT	Copyright (c) 2006-2009 Simon Thum Copyright (c) 2008-2012 Kristian Høgsberg Copyright (c) 2010-2012 Intel Corporation Copyright (c) 2010-2011 Benjamin Franzke Copyright (c) 2011-2012 Collabora, Ltd. Copyright (c) 2013-2014 Jonas Ådahl Copyright (c) 2013-2015 Red Hat, Inc.
libjpeg-turbo 1.5.1	IJG	Copyright (c) 1997-2009 by Guido Vollbeding. Copyright (c) 2010-2011, D. R. Commander.
libogg 1.3.2	BSD-3-Clause	Copyright (c) 2002, Xiph.Org.



libpcre 8.41	BSD-3-Clause	Copyright (c) 2007-2012, Google Inc. Copyright (c) 2009-2017 Zoltan Herczeg Copyright (c) 1997-2017 University of Cambridge
libphonenumber	Apache-2.0	
libpng 1.6.28	Libpng	Copyright (c) 1998-2015 Glenn Randers-Pehrson Copyright (c) 1996-1997 Andreas Dilger Copyright (c) 1995-1996 Guy Eric Schalnat, Group 42, Inc.
libpthread-stubs 0.3	X11	Copyright (c), 2006 Diego Pettenò
libsamplerate 0.1.9	BSD-2-Clause	Copyright (c) 2012-2016, Erik de Castro Lopo
libsolv 0.6.24	BSD-3-Clause	Copyright (c) 2007, Novell Inc.
libtheora 1.1.1	BSD-3-Clause	Copyright (C) 2002-2009 Xiph.org Foundation
libtirpc 0.2.5	BSD-3-Clause	Copyright (c) Copyright (c) Bull S.A. 2005
libunwind	MIT	Copyright (c) 2002 Hewlett-Packard Co.
libva 1.7.2	MIT	Copyright (c) 2007-2015, Intel Corporation.
libva-intel-driver 1.7.1	MIT	Copyright (c) 2012 Intel Corporation.
libvorbis 1.3.5	BSD-3-Clause	Copyright (c) 2002-2015 Xiph.org Foundation
libwebp 0.4.3	BSD-3-Clause	Copyright (c) 2010, Google Inc.
libxkbcommon 0.5.0	MIT-like License (libxkbcommon)	
libxml2 2.9.4	MIT	Copyright (c) 1998-2012 Daniel Veillard.
libxslt 1.1.29	X11	Copyright (c) 2001-2002 Thomas Broyer, Charlie Bozeman and Daniel Veillard.
libyaml 0.1.7	MIT	Copyright (c) 2006, Kirill Simonov
libzen 0.4.34	Zlib	Copyright (c) 2002-2014, MediaArea.net SARL.
Lightfeather 0.9.6	Zlib	Copyright (c) 2004-2010 The Lightfeather Maintainers and Contributors.
lighttpd 1.4.45	BSD-3-Clause	Copyright (c) 2004, Jan Kneschke, incremental



Linux-PAM 1.2.1	BSD-3-Clause	Copyright (C) YEAR Linux-PAM Project Copyright (c) 2005, 2006 Thorsten Kukuk <kukuk@suse.de>
LK	BSD-2-Clause BSD-3-Clause MIT	Copyright (c) 2008, Google Inc. Copyright (C) 2008 The Android Open Source Project Copyright (c) 2009, Google Inc. Copyright (c) 2001-2004 Swedish Institute of Computer Science. Copyright (c) 2008-2015 Travis Geiselbrecht
lms 8.0.0-7	BSD-3-Clause	Copyright (c) 2004-2012, Intel Corporation
lsof 4.89	MIT-like License (lsof)	Copyright (c) 2002, Purdue Research Foundation.
mailx 12.5	BSD-4-Clause	
mbed TLS 2.1.0	Apache-2.0	Copyright (c) 2006-2015, ARM Limited
mDNSResponder 765.20.4	Apache-2.0 BSD-3-Clause NICTA Public Software Licence 1.0	Copyright (c) 1997-2011, Apple Computer, Inc. Copyright (c) 2004, National ICT Australia Ltd Copyright (c) 1999-2002, The OpenSSL Project. Copyright (c) 1995-1998, Eric Young Copyright (c) 1995-1999, WIDE Project.
MediaInfoLib 0.7.67	BSD-2-Clause	Copyright (c) 2002-2014 MediaArea.net SARL.
Mesa3D 11.2.1	MIT SGI-B-2.0	Copyright (c) 1999-2003 Brian Paul Copyright (c) 1991-2000 Silicon Graphics, Inc.
Mktemp 1.7	ISC	Copyright (c) 1996-1997, 2000-2001, 2008, 2010 Todd C. Miller <Todd.Miller@courtesan.com> Copyright (c) 1996, David Mazieres <dm@uun.org> Copyright (c) 2008, Damien Miller <djm@openbsd.org>
mtdev 1.1.5	MIT	Copyright (C) 2010 Henrik Rydberg Copyright (C) 2010 Canonical Ltd.



musl-libc 1.1.16	BSD-2-Clause BSD-like License (musl) ISC MIT	Copyright (c) 2005-2014 Rich Felker, et al. Copyright (c) 2005 Bruce D. Evans and Steven G. Kargl Copyright (c) 2001-2009 Ville Laurikari <vl@iki.fi> Copyright (C) 1993 by Sun Microsystems, Inc. Copyright (c) 2008 Stephen L. Moshier <steve@moshier.net> Copyright (c) 2005-2014 Rich Felker, et al.
Namespace Support 1.11	Artistic-1.0	Copyright (c) Robin Berjon
ncurses 6.0	MIT-like License (ncurses)	Copyright (c) 1998-2014,2015 Free Software Foundation, Inc.
nowide	BSL-1.0	Copyright (c) 2012 Artyom Beilis (Tonkikh)
olsrd 0.6.5.2	olsrd 0.6.5.2	Copyright (c) by the OLSR project
openssl 1.0.2k	OpenSSL	
OpenTimeCE	MIT	Copyright (c) 2006-2011 OpenNETCF Consulting
Opus 1.2.1	BSD-3-Clause	Copyright (c) 2006-2011, Skype Limited. Copyright (c) 2007-2008, CSIRO Copyright (c) 2007-2013, Xiph.Org Foundation Copyright (c) 2008-2012, Gregory Maxwell Copyright (c) 2008-2011, Octasic Inc. Copyright (c) 2002-2012, Jean-Marc Valin Copyright (c) 2001-2011, Timothy B. Terriberry Copyright (c) 2003-2004, Mark Borgerding Copyright (c) 2001 Erik de Castro Lopo
orc 0.4.23	BSD-2-Clause BSD-3-Clause	Copyright (c) 2002-2009 David A. Schleaf Copyright (c) 1997 - 2002, Makoto Matsumoto and Takuji Nishimura
OSSP-uuid 1.6.2	MIT-like License (OSSP-uuid)	Copyright (c) 2004-2008 Ralf S. Engelschall <rse@engelschall.com> Copyright (c) 2004-2008 The OSSP Project <http://www.oss.org/>
p11-kit 0.22.1	BSD-3-Clause	Copyright (c) 2011, Collabora Ltd. Copyright (c) 2013, Red Hat Inc.



pax 3.4	BSD-3-Clause	Copyright (c) 1992 Keith Muller. Copyright (c) 1992, 1993 The Regents of the University of California.
pbzip2 1.1.13	BSD-4-Clause	Copyright (c) 2003-2011, Jeff Gilchrist Copyright (c) 1996-2008, Julian R Seward. All rights reserved.
perl 5.24.1	Artistic-1.0-Perl	Copyright (c) 1993, 1994, 1995, 1996, 1997, 1998, 1999, 2000, 2001, 2002, 2003, 2004, 2005, 2006, 2007, 2008, 2009, 2010, 2011, 2012, 2013, 2014, 2015, 2016, 2017 by Larry Wall and others
pigz 2.3.4	Apache-2.0 Zlib	Copyright (C) 2008, 2011, 2012, 2015 Mark Adler
Pipe Viewer 1.5.3	Artistic-2.0	
Pixman 0.32.0	MIT	Copyright (c) 1987, 1988, 1989, 1998 The Open Group Copyright (c) 1987, 1988, 1989 Digital Equipment Corporation Copyright (c) 1999, 2004, 2008 Keith Packard Copyright (c) 2000 SuSE, Inc. Copyright (c) 2000 Keith Packard, member of The XFree86 Project, Inc. Copyright (c) 2004, 2005, 2007, 2008, 2009, 2010 Red Hat, Inc. Copyright (c) 2004 Nicholas Miell Copyright (c) 2005 Lars Knoll & Zack Rusin, Trolltech Copyright (c) 2005 Trolltech AS Copyright (c) 2007 Luca Barbato Copyright (c) 2008 Aaron Plattner, NVIDIA Corporation Copyright (c) 2008 Rodrigo Kumpera Copyright (c) 2008 André Tupinambá Copyright (c) 2008 Mozilla Corporation Copyright (c) 2008 Frederic Plourde Copyright (c) 2009, Oracle and/or its affiliates. All rights reserved. Copyright (c) 2009, 2010 Nokia Corporation



pixz 1.0.6	BSD-2-Clause	Copyright (c) 2008, Steven G. Johnson Copyright (c) 2011, Daniel Richard G. Copyright (c) 2009-2011, Dave Vasilevsky
Pod-Plainer 1.04	Artistic-1.0-Perl	Copyright (c) 2009, 2010, 2014, Robin Barker
popt 1.16	X11	Copyright (c) 1998, Red Hat Software
Protocol Buffers 2.6.1	BSD-3-Clause	Copyright (c) 2008 Google Inc.
puzzles	MIT	Copyright (c) 2004-2014, Simon Tatham.
python 2.7.12	Python-2.0	
quota 4.03	BSD-4-Clause	Copyright (c) 1980, 1990 Regents of the University of California. Copyright (C) 2000, 2001 Silicon Graphics, Inc. [SGI]
RapidXml	MIT	Copyright (C) 2006, 2009 Marcin Kalicinski
rpcbind 0.2.4	BSD-3-Clause	Copyright (c) 2005, Bull S.A.
rpcbind 0.2.3	BSD-3-Clause	Copyright (c) 2005 Bull S.A.
rpm 5.4.14	BSD-3-Clause	
run-postinsts 1.0	MIT	
settings-daemon 0.0.2	HPND	Copyright (c) 2001, 2007 Red Hat, Inc.
shadow 4.5	Artistic-1.0 BSD-2-Clause BSD-3-Clause	Copyright (c) 2007 - 2011, Nicolas François Copyright (c) 1989 - 1994, Julianne Frances Haugh Copyright (c) 1991 - 1993, Chip Rosenthal Copyright (c) 1996 - 2000, Marek Michałkiewicz Copyright (c) 2001 - 2007, Tomasz Kłoczko
shadow-securetty 4.2.1	MIT	



shadow-sysroot 4.2.1	BSD-3-Clause	<p>Copyright (c) 2013, Eric Biederman</p> <p>Copyright (c) 1992-2003, Free Software Foundation Inc.</p> <p>Copyright (c) 1997, Guy Maor</p> <p>Copyright (c) 2000, International Business Machines</p> <p>Copyright (c) 2006, Jonas Meurer</p> <p>Copyright (c) 1989-1994, Julianne Frances Haugh</p> <p>Copyright (c) 1996-2001, Marek Michałkiewicz</p> <p>Copyright (c) 1996, Michael Meskes</p> <p>Copyright (c) 2007-2013, Nicolas François</p> <p>Copyright (c) 2004, The FreeBSD Project.</p> <p>Copyright (c) 2000-2006, Tomasz Kłoczko</p> <p>Copyright (c) 1995, Wietse Venema</p>
shutdown-desktop	MIT	
speex 1.2rc2	BSD-3-Clause	<p>Copyright 2002-2008 Xiph.org Foundation</p> <p>Copyright 2002-2008 Jean-Marc Valin</p> <p>Copyright 2005-2007 Analog Devices Inc.</p> <p>Copyright 2005-2008 Commonwealth Scientific and Industrial Research Organisation (CSIRO)</p> <p>Copyright 1993, 2002, 2006 David Rowe</p> <p>Copyright 2003 EpicGames</p> <p>Copyright 1992-1994 Jutta Degener, Carsten Bormann</p>
strace 4.13	BSD-3-Clause	<p>Copyright (c) 1991, 1992 Paul Kranenburg <pk@cs.few.eur.nl></p> <p>Copyright (c) 1993 Branko Lankester <branko@hacktic.nl></p> <p>Copyright (c) 1993 Ulrich Pegelow <pegelow@moorea.uni-muenster.de></p> <p>Copyright (c) 1995, 1996 Michael Elizabeth Chastain <mec@duracef.shout.net></p> <p>Copyright (c) 1993, 1994, 1995, 1996 Rick Sladkey <jrs@world.std.com></p> <p>Copyright (C) 1998-2001 Wichert Akkerman <wakkerma@deephackmode.org></p>



sudo 1.8.18	MIT-like License (sudo)	Copyright (c) 1994-1996, 1998-2015, Todd C. Miller <Todd.Miller@courtesan.com> Copyright (c) 2001, Emin Martinian Copyright (c) 2008, Otto Moerbeek <otto@drijf.net> Copyright (c) 1989, 1990, 1991, 1993, The Regents of the University of California. Copyright (c) 2011, VMware, Inc. Copyright (c) 2000, The NetBSD Foundation, Inc. Copyright (c) 1996, Internet Software Consortium. Copyright (C) 1995-2017, Jean-loup Gailly and Mark Adler
tcl 8.4.12	TCL	Copyright (c) the University of California, Sun Microsystems, Inc., Scriptics Corporation, ActiveState Corporation and other parties.
tcp-wrappers 7.6	BSD-like License (tcp-wrappers)	Copyright 1995 by Wietse Venema. Some individual files may be covered by other copyrights.
tcpdump 4.9.0	BSD-3-Clause	Copyright (c) 1998-2015, The Tcpdump Project
tiff 4.0.8	libtiff	Copyright (c) 1988-1997 Sam Leffler Copyright (c) 1991-1997 Silicon Graphics, Inc.
tinyxml 2.6.0	Zlib	Copyright (c) Lee Thomason (www.grinninglizard.com)
TinyXML-2	Zlib	
ttf-bitstream-vera 1.10	Bitstream Vera License 1.0	Copyright (c) 2003, Bitstream, Inc.
tzcode 2016j	BSD-3-Clause	Copyright (c) 1985, 1987, 1988 The Regents of the University of California
tzdata 2016j	BSD-3-Clause	Copyright (c) 1985-1991 The Regents of the University of California.
unzip 6.0	Info-ZIP	Copyright (c) 1990-2009 Info-ZIP.
Uthash	BSD-like License (Uthash)	Copyright (c) 2005-2016, Troy D. Hanson http://troydhanson.github.com/uthash/
util-macros 1.19.0	MIT-like License (util-macros)	Copyright 2005 Red Hat, Inc. Copyright (c) 2005, 2006, Oracle and/or its affiliates.
waffle 1.5.2	BSD-2-Clause	Copyright (c) 2012, Intel Corporation



Wapiti	BSD-2-Clause	opyright (c) 2009-2013 CNRS
Wayland 1.10.0	MIT	Copyright (c) 2008-2012 Kristian Høgsberg Copyright (c) 2010-2012 Intel Corporation Copyright (c) 2011 Benjamin Franzke Copyright (c) 2012 Collabora, Ltd.
wayland-ivi-extension 1.3.91	Apache-2.0	Copyright (c) 2010,2011, BMW Car IT GmbH Copyright (c) 2011, DENSO CORPORATION and Robert Bosch Car Multimedia GmbH
Weston 1.10.0	MIT	Copyright (c) 2008-2012 Kristian Høgsberg Copyright (c) 2010-2012 Intel Corporation Copyright (c) 2010-2011 Benjamin Franzke Copyright (c) 2011-2012 Collabora, Ltd.
weston-init 1.0	MIT	
wpa_supplicant 2.5	BSD-3-Clause	Copyright (c) 2002-2015, Jouni Malinen <j@w1.fi> and contributors
xdg-utils 1.1.1	MIT	Copyright (c) 2009-2010, Fathi Boudra <fabo@freedesktop.org> Copyright (c) 2009-2010, Rex Dieter <rdieter@fedoraproject.org> Copyright (c) 2006, Kevin Krammer <kevin.krammer@gmx.at> Copyright (c) 2006, Jeremy White <jwhite@codeweavers.com> Copyright (c) 2006, Benedikt Meurer <benny@xfce.org> Copyright (c) 2006, Bryce Harrington <bryce@osdl.org> Copyright (c) 2006, 2008 Junio C Hamano
xinetd 2.3.15	xinetd	(c) Copyright 1992 by Panagiotis Tsirigotis
xinput calibrator 0.7.5	MIT	Copyright (c) 2010 Tias Guns <tias@ulyssis.org> and others



xkeyboard-config 2.19	MIT-like License (xkeyboard-config)	<p>Copyright (c) 1996, Joseph Moss</p> <p>Copyright (c) 2002-2007, Free Software Foundation, Inc.</p> <p>Copyright (c) 2003-2004, Dmitry Golubev</p> <p>Copyright (c) 2004, Gregory Mokhin</p> <p>Copyright (c) 2006, Erdal Ronahî</p> <p>Copyright (c) 1996, Digital Equipment Corporation</p> <p>Copyright (c) 1996, 1998 The Open Group</p> <p>Copyright (c) 2004-2005, Sun Microsystems, Inc.</p> <p>Copyright (c) 1996, Silicon Graphics Computer Systems, Inc.</p> <p>Copyright (c) 1996, X Consortium</p> <p>Copyright (c) 2004, 2006, Ævar Arnfrjörð Bjarmason</p>
xml-sax 0.99	Artistic-1.0	
xml-sax-base 1.08	Artistic-1.0	<p>Copyright (c) Kip Hampton</p> <p>Copyright (c) Robin Berjon</p> <p>Copyright (c) Matt Sergeant</p>
xorg-lib-libpciaccess 0.13.4	ISC MIT X11	<p>Copyright (c) 2008 Juan Romero Pardines</p> <p>Copyright (c) 2008, 2011 Mark Kettenis</p> <p>Copyright (c) 2009 Michael Lorenz</p> <p>Copyright (c) 2009, 2012 Samuel Thibault</p> <p>Copyright (c) IBM Corporation 2006, 2007</p> <p>Copyright (c) Eric Anholt 2006</p> <p>Copyright (c) Mark Kettenis 2011</p> <p>Copyright (c) Robert Millan 2012</p> <p>Copyright (c) 2007, 2008, 2009, 2011, 2012, 2013 Oracle and/or its affiliates.</p> <p>Copyright (c) 2009, 2012 Red Hat, Inc.</p> <p>Copyright (c) 2007 Paulo R. Zanoni, Tiago Vignatti</p> <p>Copyright (c) 2009 Tiago Vignatti</p> <p>Copyright (c) 2000 The XFree86 Project, Inc.</p>
XySSL 0.9	BSD-3-Clause	<p>Copyright (C) 2006-2008 Christophe Devine</p> <p>Copyright (C) 2009 Paul Bakker <polarssl_maintainer at polarssl dot org></p>
ZenLib 0.4.31	Zlib	Copyright (c) 2002-2014 MediaArea.net SARL.
zip 3.0	Info-ZIP	



zlib 1.2.11	Zlib	Copyright (C) 1995-2017 Jean-loup Gailly and Mark Adler
-------------	------	---------------------------------------------------------

This software is based in part on the work of the Independent JPEG Group

This product includes software developed by the OpenSSL Project for use in the OpenSSL Toolkit (<http://www.openssl.org/>)

AFL-2.1

The Academic Free License
v.2.1

This Academic Free License (the "License") applies to any original work of authorship (the "Original Work") whose owner (the "Licensor") has placed the following notice immediately following the copyright notice for the Original Work:

Licensed under the Academic Free License version 2.1

1) Grant of Copyright License. Licensor hereby grants You a world-wide, royalty-free, non-exclusive, perpetual, sublicenseable license to do the following:

- a) to reproduce the Original Work in copies;
- b) to prepare derivative works ("Derivative Works") based upon the Original Work;
- c) to distribute copies of the Original Work and Derivative Works to the public;
- d) to perform the Original Work publicly; and
- e) to display the Original Work publicly.

2) Grant of Patent License. Licensor hereby grants You a world-wide, royalty-free, non-exclusive, perpetual, sublicenseable license, under patent claims owned or controlled by the Licensor that are embodied in the Original Work as furnished by the Licensor, to make, use, sell and offer for sale the Original Work and Derivative Works.

3) Grant of Source Code License. The term "Source Code" means the preferred form of the Original Work for making modifications to it and all available documentation describing how to modify the Original Work. Licensor hereby agrees to provide a machine-readable copy of the Source Code of the Original Work along with each copy of the Original Work that Licensor distributes. Licensor reserves the right to satisfy this obligation by placing a machine-readable copy of the Source Code in an information repository reasonably calculated to permit inexpensive and convenient access by You for as long as Licensor continues to distribute the Original Work, and by publishing the address of that information repository in a notice immediately following the copyright notice that applies to the Original Work.

4) Exclusions From License Grant. Neither the names of Licensor, nor the names of any contributors to the Original Work, nor any of their trademarks or service marks, may be used



to endorse or promote products derived from this Original Work without express prior written permission of the Licensor. Nothing in this License shall be deemed to grant any rights to trademarks, copyrights, patents, trade secrets or any other intellectual property of Licensor except as expressly stated herein. No patent license is granted to make, use, sell or offer to sell embodiments of any patent claims other than the licensed claims defined in Section 2. No right is granted to the trademarks of Licensor even if such marks are included in the Original Work. Nothing in this License shall be interpreted to prohibit Licensor from licensing under different terms from this License any Original Work that Licensor otherwise would have a right to license.

5) This section intentionally omitted.

6) Attribution Rights. You must retain, in the Source Code of any Derivative Works that You create, all copyright, patent or trademark notices from the Source Code of the Original Work, as well as any notices of licensing and any descriptive text identified therein as an "Attribution Notice." You must cause the Source Code for any Derivative Works that You create to carry a prominent Attribution Notice reasonably calculated to inform recipients that You have modified the Original Work.

7) Warranty of Provenance and Disclaimer of Warranty. Licensor warrants that the copyright in and to the Original Work and the patent rights granted herein by Licensor are owned by the Licensor or are sublicensed to You under the terms of this License with the permission of the contributor(s) of those copyrights and patent rights. Except as expressly stated in the immediately preceding sentence, the Original Work is provided under this License on an "AS IS" BASIS and WITHOUT WARRANTY, either express or implied, including, without limitation, the warranties of NON-INFRINGEMENT, MERCHANTABILITY or FITNESS FOR A PARTICULAR PURPOSE. THE ENTIRE RISK AS TO THE QUALITY OF THE ORIGINAL WORK IS WITH YOU. This DISCLAIMER OF WARRANTY constitutes an essential part of this License. No license to Original Work is granted hereunder except under this disclaimer.

8) Limitation of Liability. Under no circumstances and under no legal theory, whether in tort (including negligence), contract, or otherwise, shall the Licensor be liable to any person for any direct, indirect, special, incidental, or consequential damages of any character arising as a result of this License or the use of the Original Work including, without limitation, damages for loss of goodwill, work stoppage, computer failure or malfunction, or any and all other commercial damages or losses. This limitation of liability shall not apply to liability for death or personal injury resulting from Licensor's negligence to the extent applicable law prohibits such limitation. Some jurisdictions do not allow the exclusion or limitation of incidental or consequential damages, so this exclusion and limitation may not apply to You.

9) Acceptance and Termination. If You distribute copies of the Original Work or a Derivative Work, You must make a reasonable effort under the circumstances to obtain the express assent of recipients to the terms of this License. Nothing else but this License (or another written agreement between Licensor and You) grants You permission to create Derivative Works based upon the Original Work or to exercise any of the rights granted in Section 1



herein, and any attempt to do so except under the terms of this License (or another written agreement between Licensor and You) is expressly prohibited by U.S. copyright law, the equivalent laws of other countries, and by international treaty. Therefore, by exercising any of the rights granted to You in Section 1 herein, You indicate Your acceptance of this License and all of its terms and conditions.

10) Termination for Patent Action. This License shall terminate automatically and You may no longer exercise any of the rights granted to You by this License as of the date You commence an action, including a cross-claim or counterclaim, against Licensor or any licensee alleging that the Original Work infringes a patent. This termination provision shall not apply for an action alleging patent infringement by combinations of the Original Work with other software or hardware.

11) Jurisdiction, Venue and Governing Law. Any action or suit relating to this License may be brought only in the courts of a jurisdiction wherein the Licensor resides or in which Licensor conducts its primary business, and under the laws of that jurisdiction excluding its conflict-of-law provisions. The application of the United Nations Convention on Contracts for the International Sale of Goods is expressly excluded. Any use of the Original Work outside the scope of this License or after its termination shall be subject to the requirements and penalties of the U.S. Copyright Act, 17 U.S.C. § 101 et seq., the equivalent laws of other countries, and international treaty. This section shall survive the termination of this License.

12) Attorneys Fees. In any action to enforce the terms of this License or seeking damages relating thereto, the prevailing party shall be entitled to recover its costs and expenses, including, without limitation, reasonable attorneys' fees and costs incurred in connection with such action, including any appeal of such action. This section shall survive the termination of this License.

13) Miscellaneous. This License represents the complete agreement concerning the subject matter hereof. If any provision of this License is held to be unenforceable, such provision shall be reformed only to the extent necessary to make it enforceable.

14) Definition of "You" in This License. "You" throughout this License, whether in upper or lower case, means an individual or a legal entity exercising rights under, and complying with all of the terms of, this License. For legal entities, "You" includes any entity that controls, is controlled by, or is under common control with you. For purposes of this definition, "control" means (i) the power, direct or indirect, to cause the direction or management of such entity, whether by contract or otherwise, or (ii) ownership of fifty percent (50%) or more of the outstanding shares, or (iii) beneficial ownership of such entity.

15) Right to Use. You may use the Original Work in all ways not otherwise restricted or conditioned by this License or by law, and Licensor promises not to interfere with or be responsible for such uses by You.



This license is Copyright (C) 2003-2004 Lawrence E. Rosen. All rights reserved.

Permission is hereby granted to copy and distribute this license without modification. This license may not be modified without the express written permission of its copyright owner.

Anti-Grain Geometry Public License

Permission to copy, use, modify, sell and distribute this software is granted provided this copyright notice appears in all copies.

This software is provided "as is" without express or implied warranty, and with no claim as to its suitability for any purpose.

Apache-2.0

Apache License

Version 2.0, January 2004

<http://www.apache.org/licenses/>

TERMS AND CONDITIONS FOR USE, REPRODUCTION, AND DISTRIBUTION

1. Definitions.

"License" shall mean the terms and conditions for use, reproduction, and distribution as defined by Sections 1 through 9 of this document.

"Licensor" shall mean the copyright owner or entity authorized by the copyright owner that is granting the License.

"Legal Entity" shall mean the union of the acting entity and all other entities that control, are controlled by, or are under common control with that entity. For the purposes of this definition, "control" means (i) the power, direct or indirect, to cause the direction or management of such entity, whether by contract or otherwise, or (ii) ownership of fifty percent (50%) or more of the outstanding shares, or (iii) beneficial ownership of such entity.

"You" (or "Your") shall mean an individual or Legal Entity exercising permissions granted by this License.

"Source" form shall mean the preferred form for making modifications, including but not limited to software source code, documentation source, and configuration files.



"Object" form shall mean any form resulting from mechanical transformation or translation of a Source form, including but not limited to compiled object code, generated documentation, and conversions to other media types.

"Work" shall mean the work of authorship, whether in Source or Object form, made available under the License, as indicated by a copyright notice that is included in or attached to the work (an example is provided in the Appendix below).

"Derivative Works" shall mean any work, whether in Source or Object form, that is based on (or derived from) the Work and for which the editorial revisions, annotations, elaborations, or other modifications represent, as a whole, an original work of authorship. For the purposes of this License, Derivative Works shall not include works that remain separable from, or merely link (or bind by name) to the interfaces of, the Work and Derivative Works thereof.

"Contribution" shall mean any work of authorship, including the original version of the Work and any modifications or additions to that Work or Derivative Works thereof, that is intentionally submitted to Licensor for inclusion in the Work by the copyright owner or by an individual or Legal Entity authorized to submit on behalf of the copyright owner. For the purposes of this definition, "submitted" means any form of electronic, verbal, or written communication sent to the Licensor or its representatives, including but not limited to communication on electronic mailing lists, source code control systems, and issue tracking systems that are managed by, or on behalf of, the Licensor for the purpose of discussing and improving the Work, but excluding communication that is conspicuously marked or otherwise designated in writing by the copyright owner as "Not a Contribution."

"Contributor" shall mean Licensor and any individual or Legal Entity on behalf of whom a Contribution has been received by Licensor and subsequently incorporated within the Work.

2. Grant of Copyright License. Subject to the terms and conditions of this License, each Contributor hereby grants to You a perpetual, worldwide, non-exclusive, no-charge, royalty-free, irrevocable copyright license to reproduce, prepare Derivative Works of, publicly display, publicly perform, sublicense, and distribute the Work and such Derivative Works in Source or Object form.

3. Grant of Patent License. Subject to the terms and conditions of this License, each Contributor hereby grants to You a perpetual, worldwide, non-exclusive, no-charge, royalty-free, irrevocable (except as stated in this section) patent license to make, have made, use, offer to sell, sell, import, and otherwise transfer the Work, where such license applies only to those patent claims licensable by such Contributor that are necessarily infringed by their Contribution(s) alone or by combination of their Contribution(s) with the Work to which such Contribution(s) was submitted. If You institute patent litigation against any entity (including a cross-claim or counterclaim in a lawsuit) alleging that the Work or a Contribution incorporated within the Work constitutes direct or contributory patent infringement, then any patent licenses granted to You under this License for that Work shall terminate as of the date such



litigation is filed.

4. Redistribution. You may reproduce and distribute copies of the Work or Derivative Works thereof in any medium, with or without modifications, and in Source or Object form, provided that You meet the following conditions:

(a) You must give any other recipients of the Work or Derivative Works a copy of this License; and

(b) You must cause any modified files to carry prominent notices stating that You changed the files; and

(c) You must retain, in the Source form of any Derivative Works that You distribute, all copyright, patent, trademark, and attribution notices from the Source form of the Work, excluding those notices that do not pertain to any part of the Derivative Works; and

(d) If the Work includes a "NOTICE" text file as part of its distribution, then any Derivative Works that You distribute must include a readable copy of the attribution notices contained within such NOTICE file, excluding those notices that do not pertain to any part of the Derivative Works, in at least one of the following places: within a NOTICE text file distributed as part of the Derivative Works; within the Source form or documentation, if provided along with the Derivative Works; or, within a display generated by the Derivative Works, if and wherever such third-party notices normally appear. The contents of the NOTICE file are for informational purposes only and do not modify the License. You may add Your own attribution notices within Derivative Works that You distribute, alongside or as an addendum to the NOTICE text from the Work, provided that such additional attribution notices cannot be construed as modifying the License.

You may add Your own copyright statement to Your modifications and may provide additional or different license terms and conditions for use, reproduction, or distribution of Your modifications, or for any such Derivative Works as a whole, provided Your use, reproduction, and distribution of the Work otherwise complies with the conditions stated in this License.

5. Submission of Contributions. Unless You explicitly state otherwise, any Contribution intentionally submitted for inclusion in the Work by You to the Licensor shall be under the terms and conditions of this License, without any additional terms or conditions. Notwithstanding the above, nothing herein shall supersede or modify the terms of any separate license agreement you may have executed with Licensor regarding such Contributions.

6. Trademarks. This License does not grant permission to use the trade names, trademarks, service marks, or product names of the Licensor, except as required for reasonable and customary use in describing the origin of the Work and reproducing the content of the NOTICE



file.

7. Disclaimer of Warranty. Unless required by applicable law or agreed to in writing, Licensor provides the Work (and each Contributor provides its Contributions) on an "AS IS" BASIS, WITHOUT WARRANTIES OR CONDITIONS OF ANY KIND, either express or implied, including, without limitation, any warranties or conditions of TITLE, NON-INFRINGEMENT, MERCHANTABILITY, or FITNESS FOR A PARTICULAR PURPOSE. You are solely responsible for determining the appropriateness of using or redistributing the Work and assume any risks associated with Your exercise of permissions under this License.

8. Limitation of Liability. In no event and under no legal theory, whether in tort (including negligence), contract, or otherwise, unless required by applicable law (such as deliberate and grossly negligent acts) or agreed to in writing, shall any Contributor be liable to You for damages, including any direct, indirect, special, incidental, or consequential damages of any character arising as a result of this License or out of the use or inability to use the Work (including but not limited to damages for loss of goodwill, work stoppage, computer failure or malfunction, or any and all other commercial damages or losses), even if such Contributor has been advised of the possibility of such damages.

9. Accepting Warranty or Additional Liability. While redistributing the Work or Derivative Works thereof, You may choose to offer, and charge a fee for, acceptance of support, warranty, indemnity, or other liability obligations and/or rights consistent with this License. However, in accepting such obligations, You may act only on Your own behalf and on Your sole responsibility, not on behalf of any other Contributor, and only if You agree to indemnify, defend, and hold each Contributor harmless for any liability incurred by, or claims asserted against, such Contributor by reason of your accepting any such warranty or additional liability.

END OF TERMS AND CONDITIONS

APPENDIX: How to apply the Apache License to your work.

To apply the Apache License to your work, attach the following boilerplate notice, with the fields enclosed by brackets "[]" replaced with your own identifying information. (Don't include the brackets!) The text should be enclosed in the appropriate comment syntax for the file format. We also recommend that a file or class name and description of purpose be included on the same "printed page" as the copyright notice for easier identification within third-party archives.

Copyright [yyyy] [name of copyright owner]

Licensed under the Apache License, Version 2.0 (the "License");
you may not use this file except in compliance with the License.



You may obtain a copy of the License at

<http://www.apache.org/licenses/LICENSE-2.0>

Unless required by applicable law or agreed to in writing, software distributed under the License is distributed on an "AS IS" BASIS, WITHOUT WARRANTIES OR CONDITIONS OF ANY KIND, either express or implied. See the License for the specific language governing permissions and limitations under the License.

Artistic-1.0

The Artistic License

Preamble

The intent of this document is to state the conditions under which a Package may be copied, such that the Copyright Holder maintains some semblance of artistic control over the development of the package, while giving the users of the package the right to use and distribute the Package in a more-or-less customary fashion, plus the right to make reasonable modifications.

Definitions:

"Package" refers to the collection of files distributed by the Copyright Holder, and derivatives of that collection of files created through textual modification.

"Standard Version" refers to such a Package if it has not been modified, or has been modified in accordance with the wishes of the Copyright Holder.

"Copyright Holder" is whoever is named in the copyright or copyrights for the package.

"You" is you, if you're thinking about copying or distributing this Package.

"Reasonable copying fee" is whatever you can justify on the basis of media cost, duplication charges, time of people involved, and so on. (You will not be required to justify it to the Copyright Holder, but only to the computing community at large as a market that must bear the fee.)

"Freely Available" means that no fee is charged for the item itself, though there may be fees



involved in handling the item. It also means that recipients of the item may redistribute it under the same conditions they received it.

1. You may make and give away verbatim copies of the source form of the Standard Version of this Package without restriction, provided that you duplicate all of the original copyright notices and associated disclaimers.

2. You may apply bug fixes, portability fixes and other modifications derived from the Public Domain or from the Copyright Holder. A Package modified in such a way shall still be considered the Standard Version.

3. You may otherwise modify your copy of this Package in any way, provided that you insert a prominent notice in each changed file stating how and when you changed that file, and provided that you do at least ONE of the following:

- a) place your modifications in the Public Domain or otherwise make them Freely Available, such as by posting said modifications to Usenet or an equivalent medium, or placing the modifications on a major archive site such as ftp.uu.net, or by allowing the Copyright Holder to include your modifications in the Standard Version of the Package.
- b) use the modified Package only within your corporation or organization.
- c) rename any non-standard executables so the names do not conflict with standard executables, which must also be provided, and provide a separate manual page for each non-standard executable that clearly documents how it differs from the Standard Version.
- d) make other distribution arrangements with the Copyright Holder.

4. You may distribute the programs of this Package in object code or executable form, provided that you do at least ONE of the following:

- a) distribute a Standard Version of the executables and library files, together with instructions (in the manual page or equivalent) on where to get the Standard Version.
- b) accompany the distribution with the machine-readable source of the Package with your modifications.
- c) accompany any non-standard executables with their corresponding Standard Version executables, giving the non-standard executables non-standard names, and clearly documenting the differences in manual pages (or equivalent), together with instructions on where to get the Standard Version.
- d) make other distribution arrangements with the Copyright Holder.

5. You may charge a reasonable copying fee for any distribution of this Package. You may charge any fee you choose for support of this Package. You may not charge a fee for this Package itself. However, you may distribute this Package in aggregate with other (possibly commercial) programs as part of a larger (possibly commercial) software distribution provided that you do not advertise this Package as a product of your own.



6. The scripts and library files supplied as input to or produced as output from the programs of this Package do not automatically fall under the copyright of this Package, but belong to whomever generated them, and may be sold commercially, and may be aggregated with this Package.

7. C or perl subroutines supplied by you and linked into this Package shall not be considered part of this Package.

8. The name of the Copyright Holder may not be used to endorse or promote products derived from this software without specific prior written permission.

9. THIS PACKAGE IS PROVIDED "AS IS" AND WITHOUT ANY EXPRESS OR IMPLIED WARRANTIES, INCLUDING, WITHOUT LIMITATION, THE IMPLIED WARRANTIES OF MERCHANTABILITY AND FITNESS FOR A PARTICULAR PURPOSE.

The End

Artistic-1.0-Perl

The "Artistic License"

Preamble

The intent of this document is to state the conditions under which a Package may be copied, such that the Copyright Holder maintains some semblance of artistic control over the development of the package, while giving the users of the package the right to use and distribute the Package in a more-or-less customary fashion, plus the right to make reasonable modifications.

Definitions:

"Package" refers to the collection of files distributed by the Copyright Holder, and derivatives of that collection of files created through textual modification.

"Standard Version" refers to such a Package if it has not been modified, or has been modified in accordance with the wishes of the Copyright Holder as specified below.

"Copyright Holder" is whoever is named in the copyright or copyrights for the package.



"You" is you, if you're thinking about copying or distributing this Package.

"Reasonable copying fee" is whatever you can justify on the basis of media cost, duplication charges, time of people involved, and so on. (You will not be required to justify it to the Copyright Holder, but only to the computing community at large as a market that must bear the fee.)

"Freely Available" means that no fee is charged for the item itself, though there may be fees involved in handling the item. It also means that recipients of the item may redistribute it under the same conditions they received it.

1. You may make and give away verbatim copies of the source form of the Standard Version of this Package without restriction, provided that you duplicate all of the original copyright notices and associated disclaimers.

2. You may apply bug fixes, portability fixes and other modifications derived from the Public Domain or from the Copyright Holder. A Package modified in such a way shall still be considered the Standard Version.

3. You may otherwise modify your copy of this Package in any way, provided that you insert a prominent notice in each changed file stating how and when you changed that file, and provided that you do at least ONE of the following:

- a) place your modifications in the Public Domain or otherwise make them Freely Available, such as by posting said modifications to Usenet or an equivalent medium, or placing the modifications on a major archive site such as uunet.uu.net, or by allowing the Copyright Holder to include your modifications in the Standard Version of the Package.
- b) use the modified Package only within your corporation or organization.
- c) rename any non-standard executables so the names do not conflict with standard executables, which must also be provided, and provide a separate manual page for each non-standard executable that clearly documents how it differs from the Standard Version.
- d) make other distribution arrangements with the Copyright Holder.

4. You may distribute the programs of this Package in object code or executable form, provided that you do at least ONE of the following:

- a) distribute a Standard Version of the executables and library files, together with instructions (in the manual page or equivalent) on where to get the Standard Version.
- b) accompany the distribution with the machine-readable source of the Package with your modifications.
- c) give non-standard executables non-standard names, and clearly document the differences in manual pages (or equivalent), together with instructions on where to get the Standard



Version.

d) make other distribution arrangements with the Copyright Holder.

5. You may charge a reasonable copying fee for any distribution of this Package. You may charge any fee you choose for support of this Package. You may not charge a fee for this Package itself. However, you may distribute this Package in aggregate with other (possibly commercial) programs as part of a larger (possibly commercial) software distribution provided that you do not advertise this Package as a product of your own. You may embed this Package's interpreter within an executable of yours (by linking); this shall be construed as a mere form of aggregation, provided that the complete Standard Version of the interpreter is so embedded.

6. The scripts and library files supplied as input to or produced as output from the programs of this Package do not automatically fall under the copyright of this Package, but belong to whoever generated them, and may be sold commercially, and may be aggregated with this Package. If such scripts or library files are aggregated with this Package via the so-called "undump" or "unexec" methods of producing a binary executable image, then distribution of such an image shall neither be construed as a distribution of this Package nor shall it fall under the restrictions of Paragraphs 3 and 4, provided that you do not represent such an executable image as a Standard Version of this Package.

7. C subroutines (or comparably compiled subroutines in other languages) supplied by you and linked into this Package in order to emulate subroutines and variables of the language defined by this Package shall not be considered part of this Package, but are the equivalent of input as in Paragraph 6, provided these subroutines do not change the language in any way that would cause it to fail the regression tests for the language.

8. Aggregation of this Package with a commercial distribution is always permitted provided that the use of this Package is embedded; that is, when no overt attempt is made to make this Package's interfaces visible to the end user of the commercial distribution. Such use shall not be construed as a distribution of this Package.

9. The name of the Copyright Holder may not be used to endorse or promote products derived from this software without specific prior written permission.

10. THIS PACKAGE IS PROVIDED "AS IS" AND WITHOUT ANY EXPRESS OR IMPLIED WARRANTIES, INCLUDING, WITHOUT LIMITATION, THE IMPLIED WARRANTIES OF MERCHANTABILITY AND FITNESS FOR A PARTICULAR PURPOSE.

The End

Artistic-2.0



The Artistic License 2.0

Copyright (c) 2000-2006, The Perl Foundation.

Everyone is permitted to copy and distribute verbatim copies of this license document, but changing it is not allowed.

Preamble

This license establishes the terms under which a given free software Package may be copied, modified, distributed, and/or redistributed. The intent is that the Copyright Holder maintains some artistic control over the development of that Package while still keeping the Package available as open source and free software.

You are always permitted to make arrangements wholly outside of this license directly with the Copyright Holder of a given Package. If the terms of this license do not permit the full use that you propose to make of the Package, you should contact the Copyright Holder and seek a different licensing arrangement.

Definitions

"Copyright Holder" means the individual(s) or organization(s) named in the copyright notice for the entire Package.

"Contributor" means any party that has contributed code or other material to the Package, in accordance with the Copyright Holder's procedures.

"You" and "your" means any person who would like to copy, distribute, or modify the Package.

"Package" means the collection of files distributed by the Copyright Holder, and derivatives of that collection and/or of those files. A given Package may consist of either the Standard Version, or a Modified Version.

"Distribute" means providing a copy of the Package or making it accessible to anyone else, or in the case of a company or organization, to others outside of your company or organization.

"Distributor Fee" means any fee that you charge for Distributing this Package or providing support for this Package to another party. It does not mean licensing fees.



"Standard Version" refers to the Package if it has not been modified, or has been modified only in ways explicitly requested by the Copyright Holder.

"Modified Version" means the Package, if it has been changed, and such changes were not explicitly requested by the Copyright Holder.

"Original License" means this Artistic License as Distributed with the Standard Version of the Package, in its current version or as it may be modified by The Perl Foundation in the future.

"Source" form means the source code, documentation source, and configuration files for the Package.

"Compiled" form means the compiled bytecode, object code, binary, or any other form resulting from mechanical transformation or translation of the Source form.

Permission for Use and Modification Without Distribution

(1) You are permitted to use the Standard Version and create and use Modified Versions for any purpose without restriction, provided that you do not Distribute the Modified Version.

Permissions for Redistribution of the Standard Version

(2) You may Distribute verbatim copies of the Source form of the Standard Version of this Package in any medium without restriction, either gratis or for a Distributor Fee, provided that you duplicate all of the original copyright notices and associated disclaimers. At your discretion, such verbatim copies may or may not include a Compiled form of the Package.

(3) You may apply any bug fixes, portability changes, and other modifications made available from the Copyright Holder. The resulting Package will still be considered the Standard Version, and as such will be subject to the Original License.

Distribution of Modified Versions of the Package as Source

(4) You may Distribute your Modified Version as Source (either gratis or for a Distributor Fee, and with or without a Compiled form of the Modified Version) provided that you clearly document how it differs from the Standard Version, including, but not limited to, documenting any non-standard features, executables, or modules, and provided that you do at least ONE of the following:

(a) make the Modified Version available to the Copyright Holder of the Standard Version, under the Original License, so that the Copyright Holder may include your modifications in the



Standard Version.

(b) ensure that installation of your Modified Version does not prevent the user installing or running the Standard Version. In addition, the Modified Version must bear a name that is different from the name of the Standard Version.

(c) allow anyone who receives a copy of the Modified Version to make the Source form of the Modified Version available to others under

(i) the Original License or

(ii) a license that permits the licensee to freely copy, modify and redistribute the Modified Version using the same licensing terms that apply to the copy that the licensee received, and requires that the Source form of the Modified Version, and of any works derived from it, be made freely available in that license fees are prohibited but Distributor Fees are allowed.

Distribution of Compiled Forms of the Standard Version or Modified Versions without the Source

(5) You may Distribute Compiled forms of the Standard Version without the Source, provided that you include complete instructions on how to get the Source of the Standard Version. Such instructions must be valid at the time of your distribution. If these instructions, at any time while you are carrying out such distribution, become invalid, you must provide new instructions on demand or cease further distribution. If you provide valid instructions or cease distribution within thirty days after you become aware that the instructions are invalid, then you do not forfeit any of your rights under this license.

(6) You may Distribute a Modified Version in Compiled form without the Source, provided that you comply with Section 4 with respect to the Source of the Modified Version.

Aggregating or Linking the Package

(7) You may aggregate the Package (either the Standard Version or Modified Version) with other packages and Distribute the resulting aggregation provided that you do not charge a licensing fee for the Package. Distributor Fees are permitted, and licensing fees for other components in the aggregation are permitted. The terms of this license apply to the use and Distribution of the Standard or Modified Versions as included in the aggregation.

(8) You are permitted to link Modified and Standard Versions with other works, to embed the Package in a larger work of your own, or to build stand-alone binary or bytecode versions of applications that include the Package, and Distribute the result without restriction, provided the result does not expose a direct interface to the Package.

Items That are Not Considered Part of a Modified Version

(9) Works (including, but not limited to, modules and scripts) that merely extend or make



use of the Package, do not, by themselves, cause the Package to be a Modified Version. In addition, such works are not considered parts of the Package itself, and are not subject to the terms of this license.

General Provisions

(10) Any use, modification, and distribution of the Standard or Modified Versions is governed by this Artistic License. By using, modifying or distributing the Package, you accept this license. Do not use, modify, or distribute the Package, if you do not accept this license.

(11) If your Modified Version has been derived from a Modified Version made by someone other than you, you are nevertheless required to ensure that your Modified Version complies with the requirements of this license.

(12) This license does not grant you the right to use any trademark, service mark, tradename, or logo of the Copyright Holder.

(13) This license includes the non-exclusive, worldwide, free-of-charge patent license to make, have made, use, offer to sell, sell, import and otherwise transfer the Package with respect to any patent claims licensable by the Copyright Holder that are necessarily infringed by the Package. If you institute patent litigation (including a cross-claim or counterclaim) against any party alleging that the Package constitutes direct or contributory patent infringement, then this Artistic License to you shall terminate on the date that such litigation is filed.

(14) Disclaimer of Warranty:

THE PACKAGE IS PROVIDED BY THE COPYRIGHT HOLDER AND CONTRIBUTORS "AS IS" AND WITHOUT ANY EXPRESS OR IMPLIED WARRANTIES. THE IMPLIED WARRANTIES OF MERCHANTABILITY, FITNESS FOR A PARTICULAR PURPOSE, OR NON-INFRINGEMENT ARE DISCLAIMED TO THE EXTENT PERMITTED BY YOUR LOCAL LAW. UNLESS REQUIRED BY LAW, NO COPYRIGHT HOLDER OR CONTRIBUTOR WILL BE LIABLE FOR ANY DIRECT, INDIRECT, INCIDENTAL, OR CONSEQUENTIAL DAMAGES ARISING IN ANY WAY OUT OF THE USE OF THE PACKAGE, EVEN IF ADVISED OF THE POSSIBILITY OF SUCH DAMAGE.

BSD-2-Clause

Copyright (c) <year> <owner> All rights reserved.

Redistribution and use in source and binary forms, with or without modification, are permitted provided that the following conditions are met:

1. Redistributions of source code must retain the above copyright notice, this list of conditions



and the following disclaimer.

2. Redistributions in binary form must reproduce the above copyright notice, this list of conditions and the following disclaimer in the documentation and/or other materials provided with the distribution.

THIS SOFTWARE IS PROVIDED BY THE COPYRIGHT HOLDERS AND CONTRIBUTORS "AS IS" AND ANY EXPRESS OR IMPLIED WARRANTIES, INCLUDING, BUT NOT LIMITED TO, THE IMPLIED WARRANTIES OF MERCHANTABILITY AND FITNESS FOR A PARTICULAR PURPOSE ARE DISCLAIMED. IN NO EVENT SHALL THE COPYRIGHT HOLDER OR CONTRIBUTORS BE LIABLE FOR ANY DIRECT, INDIRECT, INCIDENTAL, SPECIAL, EXEMPLARY, OR CONSEQUENTIAL DAMAGES (INCLUDING, BUT NOT LIMITED TO, PROCUREMENT OF SUBSTITUTE GOODS OR SERVICES; LOSS OF USE, DATA, OR PROFITS; OR BUSINESS INTERRUPTION) HOWEVER CAUSED AND ON ANY THEORY OF LIABILITY, WHETHER IN CONTRACT, STRICT LIABILITY, OR TORT (INCLUDING NEGLIGENCE OR OTHERWISE) ARISING IN ANY WAY OUT OF THE USE OF THIS SOFTWARE, EVEN IF ADVISED OF THE POSSIBILITY OF SUCH DAMAGE.

BSD-3-Clause

Copyright (c) <year> <owner>. All rights reserved.

Redistribution and use in source and binary forms, with or without modification, are permitted provided that the following conditions are met:

1. Redistributions of source code must retain the above copyright notice, this list of conditions and the following disclaimer.

2. Redistributions in binary form must reproduce the above copyright notice, this list of conditions and the following disclaimer in the documentation and/or other materials provided with the distribution.

3. Neither the name of the copyright holder nor the names of its contributors may be used to endorse or promote products derived from this software without specific prior written permission.

THIS SOFTWARE IS PROVIDED BY THE COPYRIGHT HOLDERS AND CONTRIBUTORS "AS IS" AND ANY EXPRESS OR IMPLIED WARRANTIES, INCLUDING, BUT NOT LIMITED TO, THE IMPLIED WARRANTIES OF MERCHANTABILITY AND FITNESS FOR A PARTICULAR PURPOSE ARE DISCLAIMED. IN NO EVENT SHALL THE COPYRIGHT HOLDER OR CONTRIBUTORS BE LIABLE FOR ANY DIRECT, INDIRECT, INCIDENTAL, SPECIAL, EXEMPLARY, OR CONSEQUENTIAL DAMAGES (INCLUDING, BUT NOT LIMITED TO, PROCUREMENT OF SUBSTITUTE GOODS OR SERVICES; LOSS OF USE, DATA, OR PROFITS; OR BUSINESS INTERRUPTION) HOWEVER CAUSED AND ON ANY THEORY OF LIABILITY, WHETHER IN CONTRACT, STRICT LIABILITY, OR



TORT (INCLUDING NEGLIGENCE OR OTHERWISE) ARISING IN ANY WAY OUT OF THE USE OF THIS SOFTWARE, EVEN IF ADVISED OF THE POSSIBILITY OF SUCH DAMAGE.

BSD-4-Clause

Copyright (c) <year> <owner>. All rights reserved.

Redistribution and use in source and binary forms, with or without modification, are permitted provided that the following conditions are met:

1. Redistributions of source code must retain the above copyright notice, this list of conditions and the following disclaimer.

2. Redistributions in binary form must reproduce the above copyright notice, this list of conditions and the following disclaimer in the documentation and/or other materials provided with the distribution.

3. All advertising materials mentioning features or use of this software must display the following acknowledgement:

This product includes software developed by the the organization.

4. Neither the name of the copyright holder nor the names of its contributors may be used to endorse or promote products derived from this software without specific prior written permission.

THIS SOFTWARE IS PROVIDED BY COPYRIGHT HOLDER "AS IS" AND ANY EXPRESS OR IMPLIED WARRANTIES, INCLUDING, BUT NOT LIMITED TO, THE IMPLIED WARRANTIES OF MERCHANTABILITY AND FITNESS FOR A PARTICULAR PURPOSE ARE DISCLAIMED. IN NO EVENT SHALL COPYRIGHT HOLDER BE LIABLE FOR ANY DIRECT, INDIRECT, INCIDENTAL, SPECIAL, EXEMPLARY, OR CONSEQUENTIAL DAMAGES (INCLUDING, BUT NOT LIMITED TO, PROCUREMENT OF SUBSTITUTE GOODS OR SERVICES; LOSS OF USE, DATA, OR PROFITS; OR BUSINESS INTERRUPTION) HOWEVER CAUSED AND ON ANY THEORY OF LIABILITY, WHETHER IN CONTRACT, STRICT LIABILITY, OR TORT (INCLUDING NEGLIGENCE OR OTHERWISE) ARISING IN ANY WAY OUT OF THE USE OF THIS SOFTWARE, EVEN IF ADVISED OF THE POSSIBILITY OF SUCH DAMAGE.

BSD-like License (Uthash)

Redistribution and use in source and binary forms, with or without modification, are permitted provided that the following conditions are met:



* Redistributions of source code must retain the above copyright notice, this list of conditions and the following disclaimer.

THIS SOFTWARE IS PROVIDED BY THE COPYRIGHT HOLDERS AND CONTRIBUTORS "AS IS" AND ANY EXPRESS OR IMPLIED WARRANTIES, INCLUDING, BUT NOT LIMITED TO, THE IMPLIED WARRANTIES OF MERCHANTABILITY AND FITNESS FOR A PARTICULAR PURPOSE ARE DISCLAIMED. IN NO EVENT SHALL THE COPYRIGHT OWNER OR CONTRIBUTORS BE LIABLE FOR ANY DIRECT, INDIRECT, INCIDENTAL, SPECIAL, EXEMPLARY, OR CONSEQUENTIAL DAMAGES (INCLUDING, BUT NOT LIMITED TO, PROCUREMENT OF SUBSTITUTE GOODS OR SERVICES; LOSS OF USE, DATA, OR PROFITS; OR BUSINESS INTERRUPTION) HOWEVER CAUSED AND ON ANY THEORY OF LIABILITY, WHETHER IN CONTRACT, STRICT LIABILITY, OR TORT (INCLUDING NEGLIGENCE OR OTHERWISE) ARISING IN ANY WAY OUT OF THE USE OF THIS SOFTWARE, EVEN IF ADVISED OF THE POSSIBILITY OF SUCH DAMAGE.

BSD-like License (android-system-core-toolbox)

Copyright (C) 2010 The Android Open Source Project Licensed under the Apache License, Version 2.0 (the "License"); you may not use this file except in compliance with the License.

You may obtain a copy of the License at <http://www.apache.org/licenses/LICENSE-2.0>

Unless required by applicable law or agreed to in writing, software distributed under the License is distributed on an "AS IS" BASIS, WITHOUT WARRANTIES OR CONDITIONS OF ANY KIND, either express or implied.

See the License for the specific language governing permissions and limitations under the License.

 Copyright (C) 2014, The Android Open Source Project All rights reserved.

Redistribution and use in source and binary forms, with or without modification, are permitted provided that the following conditions are met:

- * Redistributions of source code must retain the above copyright notice, this list of conditions and the following disclaimer.

- * Redistributions in binary form must reproduce the above copyright notice, this list of conditions and the following disclaimer in the documentation and/or other materials provided with the distribution.

THIS SOFTWARE IS PROVIDED BY THE COPYRIGHT HOLDERS AND CONTRIBUTORS "AS IS" AND ANY EXPRESS OR IMPLIED WARRANTIES, INCLUDING, BUT NOT LIMITED TO, THE IMPLIED WARRANTIES OF MERCHANTABILITY AND FITNESS FOR A PARTICULAR PURPOSE ARE DISCLAIMED. IN NO EVENT SHALL THE COPYRIGHT OWNER OR CONTRIBUTORS BE LIABLE FOR ANY DIRECT, INDIRECT, INCIDENTAL, SPECIAL, EXEMPLARY, OR CONSEQUENTIAL DAMAGES (INCLUDING, BUT NOT LIMITED TO, PROCUREMENT OF SUBSTITUTE GOODS OR SERVICES; LOSS OF USE, DATA, OR PROFITS; OR BUSINESS INTERRUPTION) HOWEVER CAUSED AND ON ANY THEORY OF LIABILITY, WHETHER IN CONTRACT, STRICT LIABILITY, OR TORT (INCLUDING NEGLIGENCE OR OTHERWISE) ARISING IN ANY WAY OUT OF THE USE OF THIS SOFTWARE, EVEN IF ADVISED OF THE POSSIBILITY OF SUCH DAMAGE.



Copyright (c) 1987, 1993

The Regents of the University of California. All rights reserved.

Redistribution and use in source and binary forms, with or without modification, are permitted provided that the following conditions are met:

1. Redistributions of source code must retain the above copyright notice, this list of conditions and the following disclaimer.
2. Redistributions in binary form must reproduce the above copyright notice, this list of conditions and the following disclaimer in the documentation and/or other materials provided with the distribution.
3. Neither the name of the University nor the names of its contributors may be used to endorse or promote products derived from this software without specific prior written permission.

THIS SOFTWARE IS PROVIDED BY THE REGENTS AND CONTRIBUTORS ``AS IS'' AND ANY EXPRESS OR IMPLIED WARRANTIES, INCLUDING, BUT NOT LIMITED TO, THE IMPLIED WARRANTIES OF MERCHANTABILITY AND FITNESS FOR A PARTICULAR PURPOSE ARE DISCLAIMED. IN NO EVENT SHALL THE REGENTS OR CONTRIBUTORS BE LIABLE FOR ANY DIRECT, INDIRECT, INCIDENTAL, SPECIAL, EXEMPLARY, OR CONSEQUENTIAL DAMAGES (INCLUDING, BUT NOT LIMITED TO, PROCUREMENT OF SUBSTITUTE GOODS OR SERVICES; LOSS OF USE, DATA, OR PROFITS; OR BUSINESS INTERRUPTION) HOWEVER CAUSED AND ON ANY THEORY OF LIABILITY, WHETHER IN CONTRACT, STRICT LIABILITY, OR TORT (INCLUDING NEGLIGENCE OR OTHERWISE) ARISING IN ANY WAY OUT OF THE USE OF THIS SOFTWARE, EVEN IF ADVISED OF THE POSSIBILITY OF SUCH DAMAGE.

Copyright (c) 1987, 1993, 1994

The Regents of the University of California. All rights reserved.

Redistribution and use in source and binary forms, with or without modification, are permitted provided that the following conditions are met:

1. Redistributions of source code must retain the above copyright notice, this list of conditions and the following disclaimer.
2. Redistributions in binary form must reproduce the above copyright notice, this list of conditions and the following disclaimer in the documentation and/or other materials provided with the distribution.
3. Neither the name of the University nor the names of its contributors may be used to endorse or promote products derived from this software without specific prior written permission.

THIS SOFTWARE IS PROVIDED BY THE REGENTS AND CONTRIBUTORS ``AS IS'' AND ANY EXPRESS OR IMPLIED WARRANTIES, INCLUDING, BUT NOT LIMITED TO, THE IMPLIED WARRANTIES OF MERCHANTABILITY AND FITNESS FOR A PARTICULAR PURPOSE ARE DISCLAIMED. IN NO EVENT SHALL THE REGENTS OR CONTRIBUTORS BE LIABLE FOR ANY DIRECT, INDIRECT, INCIDENTAL, SPECIAL, EXEMPLARY, OR CONSEQUENTIAL DAMAGES (INCLUDING, BUT NOT LIMITED TO, PROCUREMENT OF SUBSTITUTE GOODS OR SERVICES; LOSS OF USE, DATA, OR PROFITS; OR BUSINESS INTERRUPTION) HOWEVER CAUSED AND ON



ANY THEORY OF LIABILITY, WHETHER IN CONTRACT, STRICT LIABILITY, OR TORT (INCLUDING NEGLIGENCE OR OTHERWISE) ARISING IN ANY WAY OUT OF THE USE OF THIS SOFTWARE, EVEN IF ADVISED OF THE POSSIBILITY OF SUCH DAMAGE.

Copyright (c) 1988, 1993

The Regents of the University of California. All rights reserved.

This code is derived from software contributed to Berkeley by Jeffrey Mogul.

Redistribution and use in source and binary forms, with or without modification, are permitted provided that the following conditions are met:

1. Redistributions of source code must retain the above copyright notice, this list of conditions and the following disclaimer.
2. Redistributions in binary form must reproduce the above copyright notice, this list of conditions and the following disclaimer in the documentation and/or other materials provided with the distribution.
3. Neither the name of the University nor the names of its contributors may be used to endorse or promote products derived from this software without specific prior written permission.

THIS SOFTWARE IS PROVIDED BY THE REGENTS AND CONTRIBUTORS ``AS IS'' AND ANY EXPRESS OR IMPLIED WARRANTIES, INCLUDING, BUT NOT LIMITED TO, THE IMPLIED WARRANTIES OF MERCHANTABILITY AND FITNESS FOR A PARTICULAR PURPOSE ARE DISCLAIMED. IN NO EVENT SHALL THE REGENTS OR CONTRIBUTORS BE LIABLE FOR ANY DIRECT, INDIRECT, INCIDENTAL, SPECIAL, EXEMPLARY, OR CONSEQUENTIAL DAMAGES (INCLUDING, BUT NOT LIMITED TO, PROCUREMENT OF SUBSTITUTE GOODS OR SERVICES; LOSS OF USE, DATA, OR PROFITS; OR BUSINESS INTERRUPTION) HOWEVER CAUSED AND ON ANY THEORY OF LIABILITY, WHETHER IN CONTRACT, STRICT LIABILITY, OR TORT (INCLUDING NEGLIGENCE OR OTHERWISE) ARISING IN ANY WAY OUT OF THE USE OF THIS SOFTWARE, EVEN IF ADVISED OF THE POSSIBILITY OF SUCH DAMAGE.

Copyright (c) 1988, 1993, 1994

The Regents of the University of California. All rights reserved.

Redistribution and use in source and binary forms, with or without modification, are permitted provided that the following conditions are met:

1. Redistributions of source code must retain the above copyright notice, this list of conditions and the following disclaimer.
2. Redistributions in binary form must reproduce the above copyright notice, this list of conditions and the following disclaimer in the documentation and/or other materials provided with the distribution.
3. Neither the name of the University nor the names of its contributors may be used to endorse or promote products derived from this software without specific prior written permission.

THIS SOFTWARE IS PROVIDED BY THE REGENTS AND CONTRIBUTORS ``AS IS'' AND ANY EXPRESS OR IMPLIED WARRANTIES, INCLUDING, BUT NOT LIMITED TO, THE IMPLIED WARRANTIES OF MERCHANTABILITY AND FITNESS FOR A PARTICULAR PURPOSE ARE



DISCLAIMED. IN NO EVENT SHALL THE REGENTS OR CONTRIBUTORS BE LIABLE FOR ANY DIRECT, INDIRECT, INCIDENTAL, SPECIAL, EXEMPLARY, OR CONSEQUENTIAL DAMAGES (INCLUDING, BUT NOT LIMITED TO, PROCUREMENT OF SUBSTITUTE GOODS OR SERVICES; LOSS OF USE, DATA, OR PROFITS; OR BUSINESS INTERRUPTION) HOWEVER CAUSED AND ON ANY THEORY OF LIABILITY, WHETHER IN CONTRACT, STRICT LIABILITY, OR TORT (INCLUDING NEGLIGENCE OR OTHERWISE) ARISING IN ANY WAY OUT OF THE USE OF THIS SOFTWARE, EVEN IF ADVISED OF THE POSSIBILITY OF SUCH DAMAGE.

Copyright (c) 1988, 1993, 1994

The Regents of the University of California. All rights reserved.

This code is derived from software contributed to Berkeley by David Hitz of Auspex Systems Inc.

Redistribution and use in source and binary forms, with or without modification, are permitted provided that the following conditions are met:

1. Redistributions of source code must retain the above copyright notice, this list of conditions and the following disclaimer.
2. Redistributions in binary form must reproduce the above copyright notice, this list of conditions and the following disclaimer in the documentation and/or other materials provided with the distribution.
3. Neither the name of the University nor the names of its contributors may be used to endorse or promote products derived from this software without specific prior written permission.

THIS SOFTWARE IS PROVIDED BY THE REGENTS AND CONTRIBUTORS ``AS IS'' AND ANY EXPRESS OR IMPLIED WARRANTIES, INCLUDING, BUT NOT LIMITED TO, THE IMPLIED WARRANTIES OF MERCHANTABILITY AND FITNESS FOR A PARTICULAR PURPOSE ARE DISCLAIMED. IN NO EVENT SHALL THE REGENTS OR CONTRIBUTORS BE LIABLE FOR ANY DIRECT, INDIRECT, INCIDENTAL, SPECIAL, EXEMPLARY, OR CONSEQUENTIAL DAMAGES (INCLUDING, BUT NOT LIMITED TO, PROCUREMENT OF SUBSTITUTE GOODS OR SERVICES; LOSS OF USE, DATA, OR PROFITS; OR BUSINESS INTERRUPTION) HOWEVER CAUSED AND ON ANY THEORY OF LIABILITY, WHETHER IN CONTRACT, STRICT LIABILITY, OR TORT (INCLUDING NEGLIGENCE OR OTHERWISE) ARISING IN ANY WAY OUT OF THE USE OF THIS SOFTWARE, EVEN IF ADVISED OF THE POSSIBILITY OF SUCH DAMAGE.

Copyright (c) 1988, 1993, 1994, 2003

The Regents of the University of California. All rights reserved.

Redistribution and use in source and binary forms, with or without modification, are permitted provided that the following conditions are met:

1. Redistributions of source code must retain the above copyright notice, this list of conditions and the following disclaimer.
2. Redistributions in binary form must reproduce the above copyright notice, this list of conditions and the following disclaimer in the documentation and/or other materials provided with the distribution.
3. Neither the name of the University nor the names of its contributors may be used to



endorse or promote products derived from this software without specific prior written permission.

THIS SOFTWARE IS PROVIDED BY THE REGENTS AND CONTRIBUTORS ``AS IS'' AND ANY EXPRESS OR IMPLIED WARRANTIES, INCLUDING, BUT NOT LIMITED TO, THE IMPLIED WARRANTIES OF MERCHANTABILITY AND FITNESS FOR A PARTICULAR PURPOSE ARE DISCLAIMED. IN NO EVENT SHALL THE REGENTS OR CONTRIBUTORS BE LIABLE FOR ANY DIRECT, INDIRECT, INCIDENTAL, SPECIAL, EXEMPLARY, OR CONSEQUENTIAL DAMAGES (INCLUDING, BUT NOT LIMITED TO, PROCUREMENT OF SUBSTITUTE GOODS OR SERVICES; LOSS OF USE, DATA, OR PROFITS; OR BUSINESS INTERRUPTION) HOWEVER CAUSED AND ON ANY THEORY OF LIABILITY, WHETHER IN CONTRACT, STRICT LIABILITY, OR TORT (INCLUDING NEGLIGENCE OR OTHERWISE) ARISING IN ANY WAY OUT OF THE USE OF THIS SOFTWARE, EVEN IF ADVISED OF THE POSSIBILITY OF SUCH DAMAGE.

Copyright (c) 1989, 1993

The Regents of the University of California. All rights reserved.

Redistribution and use in source and binary forms, with or without modification, are permitted provided that the following conditions are met:

1. Redistributions of source code must retain the above copyright notice, this list of conditions and the following disclaimer.
2. Redistributions in binary form must reproduce the above copyright notice, this list of conditions and the following disclaimer in the documentation and/or other materials provided with the distribution.
3. Neither the name of the University nor the names of its contributors may be used to endorse or promote products derived from this software without specific prior written permission.

THIS SOFTWARE IS PROVIDED BY THE REGENTS AND CONTRIBUTORS ``AS IS'' AND ANY EXPRESS OR IMPLIED WARRANTIES, INCLUDING, BUT NOT LIMITED TO, THE IMPLIED WARRANTIES OF MERCHANTABILITY AND FITNESS FOR A PARTICULAR PURPOSE ARE DISCLAIMED. IN NO EVENT SHALL THE REGENTS OR CONTRIBUTORS BE LIABLE FOR ANY DIRECT, INDIRECT, INCIDENTAL, SPECIAL, EXEMPLARY, OR CONSEQUENTIAL DAMAGES (INCLUDING, BUT NOT LIMITED TO, PROCUREMENT OF SUBSTITUTE GOODS OR SERVICES; LOSS OF USE, DATA, OR PROFITS; OR BUSINESS INTERRUPTION) HOWEVER CAUSED AND ON ANY THEORY OF LIABILITY, WHETHER IN CONTRACT, STRICT LIABILITY, OR TORT (INCLUDING NEGLIGENCE OR OTHERWISE) ARISING IN ANY WAY OUT OF THE USE OF THIS SOFTWARE, EVEN IF ADVISED OF THE POSSIBILITY OF SUCH DAMAGE.

Copyright (c) 1989, 1993

The Regents of the University of California. All rights reserved.

This code is derived from software contributed to Berkeley by Kevin Fall.

Redistribution and use in source and binary forms, with or without modification, are permitted provided that the following conditions are met:

1. Redistributions of source code must retain the above copyright notice, this list of conditions and the following disclaimer.



2. Redistributions in binary form must reproduce the above copyright notice, this list of conditions and the following disclaimer in the documentation and/or other materials provided with the distribution.

3. Neither the name of the University nor the names of its contributors may be used to endorse or promote products derived from this software without specific prior written permission.

THIS SOFTWARE IS PROVIDED BY THE REGENTS AND CONTRIBUTORS ``AS IS" AND ANY EXPRESS OR IMPLIED WARRANTIES, INCLUDING, BUT NOT LIMITED TO, THE IMPLIED WARRANTIES OF MERCHANTABILITY AND FITNESS FOR A PARTICULAR PURPOSE ARE DISCLAIMED. IN NO EVENT SHALL THE REGENTS OR CONTRIBUTORS BE LIABLE FOR ANY DIRECT, INDIRECT, INCIDENTAL, SPECIAL, EXEMPLARY, OR CONSEQUENTIAL DAMAGES (INCLUDING, BUT NOT LIMITED TO, PROCUREMENT OF SUBSTITUTE GOODS OR SERVICES; LOSS OF USE, DATA, OR PROFITS; OR BUSINESS INTERRUPTION) HOWEVER CAUSED AND ON ANY THEORY OF LIABILITY, WHETHER IN CONTRACT, STRICT LIABILITY, OR TORT (INCLUDING NEGLIGENCE OR OTHERWISE) ARISING IN ANY WAY OUT OF THE USE OF THIS SOFTWARE, EVEN IF ADVISED OF THE POSSIBILITY OF SUCH DAMAGE.

Copyright (c) 1989, 1993, 1994

The Regents of the University of California. All rights reserved.

This code is derived from software contributed to Berkeley by Chris Newcomb.

Redistribution and use in source and binary forms, with or without modification, are permitted provided that the following conditions are met:

1. Redistributions of source code must retain the above copyright notice, this list of conditions and the following disclaimer.

2. Redistributions in binary form must reproduce the above copyright notice, this list of conditions and the following disclaimer in the documentation and/or other materials provided with the distribution.

3. Neither the name of the University nor the names of its contributors may be used to endorse or promote products derived from this software without specific prior written permission.

THIS SOFTWARE IS PROVIDED BY THE REGENTS AND CONTRIBUTORS ``AS IS" AND ANY EXPRESS OR IMPLIED WARRANTIES, INCLUDING, BUT NOT LIMITED TO, THE IMPLIED WARRANTIES OF MERCHANTABILITY AND FITNESS FOR A PARTICULAR PURPOSE ARE DISCLAIMED. IN NO EVENT SHALL THE REGENTS OR CONTRIBUTORS BE LIABLE FOR ANY DIRECT, INDIRECT, INCIDENTAL, SPECIAL, EXEMPLARY, OR CONSEQUENTIAL DAMAGES (INCLUDING, BUT NOT LIMITED TO, PROCUREMENT OF SUBSTITUTE GOODS OR SERVICES; LOSS OF USE, DATA, OR PROFITS; OR BUSINESS INTERRUPTION) HOWEVER CAUSED AND ON ANY THEORY OF LIABILITY, WHETHER IN CONTRACT, STRICT LIABILITY, OR TORT (INCLUDING NEGLIGENCE OR OTHERWISE) ARISING IN ANY WAY OUT OF THE USE OF THIS SOFTWARE, EVEN IF ADVISED OF THE POSSIBILITY OF SUCH DAMAGE.

Copyright (c) 1989, 1993, 1994

The Regents of the University of California. All rights reserved.



This code is derived from software contributed to Berkeley by Ken Smith of The State University of New York at Buffalo.

Redistribution and use in source and binary forms, with or without modification, are permitted provided that the following conditions are met:

1. Redistributions of source code must retain the above copyright notice, this list of conditions and the following disclaimer.
2. Redistributions in binary form must reproduce the above copyright notice, this list of conditions and the following disclaimer in the documentation and/or other materials provided with the distribution.
3. Neither the name of the University nor the names of its contributors may be used to endorse or promote products derived from this software without specific prior written permission.

THIS SOFTWARE IS PROVIDED BY THE REGENTS AND CONTRIBUTORS ``AS IS'' AND ANY EXPRESS OR IMPLIED WARRANTIES, INCLUDING, BUT NOT LIMITED TO, THE IMPLIED WARRANTIES OF MERCHANTABILITY AND FITNESS FOR A PARTICULAR PURPOSE ARE DISCLAIMED. IN NO EVENT SHALL THE REGENTS OR CONTRIBUTORS BE LIABLE FOR ANY DIRECT, INDIRECT, INCIDENTAL, SPECIAL, EXEMPLARY, OR CONSEQUENTIAL DAMAGES (INCLUDING, BUT NOT LIMITED TO, PROCUREMENT OF SUBSTITUTE GOODS OR SERVICES; LOSS OF USE, DATA, OR PROFITS; OR BUSINESS INTERRUPTION) HOWEVER CAUSED AND ON ANY THEORY OF LIABILITY, WHETHER IN CONTRACT, STRICT LIABILITY, OR TORT (INCLUDING NEGLIGENCE OR OTHERWISE) ARISING IN ANY WAY OUT OF THE USE OF THIS SOFTWARE, EVEN IF ADVISED OF THE POSSIBILITY OF SUCH DAMAGE.

Copyright (c) 1990, 1993, 1994, 2003

The Regents of the University of California. All rights reserved.

Redistribution and use in source and binary forms, with or without modification, are permitted provided that the following conditions are met:

1. Redistributions of source code must retain the above copyright notice, this list of conditions and the following disclaimer.
2. Redistributions in binary form must reproduce the above copyright notice, this list of conditions and the following disclaimer in the documentation and/or other materials provided with the distribution.
3. Neither the name of the University nor the names of its contributors may be used to endorse or promote products derived from this software without specific prior written permission.

THIS SOFTWARE IS PROVIDED BY THE REGENTS AND CONTRIBUTORS ``AS IS'' AND ANY EXPRESS OR IMPLIED WARRANTIES, INCLUDING, BUT NOT LIMITED TO, THE IMPLIED WARRANTIES OF MERCHANTABILITY AND FITNESS FOR A PARTICULAR PURPOSE ARE DISCLAIMED. IN NO EVENT SHALL THE REGENTS OR CONTRIBUTORS BE LIABLE FOR ANY DIRECT, INDIRECT, INCIDENTAL, SPECIAL, EXEMPLARY, OR CONSEQUENTIAL DAMAGES (INCLUDING, BUT NOT LIMITED TO, PROCUREMENT OF SUBSTITUTE GOODS OR SERVICES; LOSS OF USE, DATA, OR PROFITS; OR BUSINESS INTERRUPTION) HOWEVER CAUSED AND ON ANY THEORY OF LIABILITY, WHETHER IN CONTRACT, STRICT LIABILITY, OR TORT (INCLUDING NEGLIGENCE OR OTHERWISE) ARISING IN ANY WAY OUT OF THE USE OF THIS SOFTWARE,



EVEN IF ADVISED OF THE POSSIBILITY OF SUCH DAMAGE.

Copyright (c) 1991, 1993

The Regents of the University of California. All rights reserved.

Redistribution and use in source and binary forms, with or without modification, are permitted provided that the following conditions are met:

1. Redistributions of source code must retain the above copyright notice, this list of conditions and the following disclaimer.
2. Redistributions in binary form must reproduce the above copyright notice, this list of conditions and the following disclaimer in the documentation and/or other materials provided with the distribution.
3. Neither the name of the University nor the names of its contributors may be used to endorse or promote products derived from this software without specific prior written permission.

THIS SOFTWARE IS PROVIDED BY THE REGENTS AND CONTRIBUTORS "AS IS" AND ANY EXPRESS OR IMPLIED WARRANTIES, INCLUDING, BUT NOT LIMITED TO, THE IMPLIED WARRANTIES OF MERCHANTABILITY AND FITNESS FOR A PARTICULAR PURPOSE ARE DISCLAIMED. IN NO EVENT SHALL THE REGENTS OR CONTRIBUTORS BE LIABLE FOR ANY DIRECT, INDIRECT, INCIDENTAL, SPECIAL, EXEMPLARY, OR CONSEQUENTIAL DAMAGES (INCLUDING, BUT NOT LIMITED TO, PROCUREMENT OF SUBSTITUTE GOODS OR SERVICES; LOSS OF USE, DATA, OR PROFITS; OR BUSINESS INTERRUPTION) HOWEVER CAUSED AND ON ANY THEORY OF LIABILITY, WHETHER IN CONTRACT, STRICT LIABILITY, OR TORT (INCLUDING NEGLIGENCE OR OTHERWISE) ARISING IN ANY WAY OUT OF THE USE OF THIS SOFTWARE, EVEN IF ADVISED OF THE POSSIBILITY OF SUCH DAMAGE.

Copyright (c) 1991, 1993, 1994

The Regents of the University of California. All rights reserved.

Redistribution and use in source and binary forms, with or without modification, are permitted provided that the following conditions are met:

1. Redistributions of source code must retain the above copyright notice, this list of conditions and the following disclaimer.
2. Redistributions in binary form must reproduce the above copyright notice, this list of conditions and the following disclaimer in the documentation and/or other materials provided with the distribution.
3. Neither the name of the University nor the names of its contributors may be used to endorse or promote products derived from this software without specific prior written permission.

THIS SOFTWARE IS PROVIDED BY THE REGENTS AND CONTRIBUTORS "AS IS" AND ANY EXPRESS OR IMPLIED WARRANTIES, INCLUDING, BUT NOT LIMITED TO, THE IMPLIED WARRANTIES OF MERCHANTABILITY AND FITNESS FOR A PARTICULAR PURPOSE ARE DISCLAIMED. IN NO EVENT SHALL THE REGENTS OR CONTRIBUTORS BE LIABLE FOR ANY DIRECT, INDIRECT, INCIDENTAL, SPECIAL, EXEMPLARY, OR CONSEQUENTIAL DAMAGES (INCLUDING, BUT NOT LIMITED TO, PROCUREMENT OF SUBSTITUTE GOODS OR SERVICES;



LOSS OF USE, DATA, OR PROFITS; OR BUSINESS INTERRUPTION) HOWEVER CAUSED AND ON ANY THEORY OF LIABILITY, WHETHER IN CONTRACT, STRICT LIABILITY, OR TORT (INCLUDING NEGLIGENCE OR OTHERWISE) ARISING IN ANY WAY OUT OF THE USE OF THIS SOFTWARE, EVEN IF ADVISED OF THE POSSIBILITY OF SUCH DAMAGE.

Copyright (c) 1991, 1993, 1994

The Regents of the University of California. All rights reserved.

This code is derived from software contributed to Berkeley by Keith Muller of the University of California, San Diego and Lance Visser of Convex Computer Corporation.

Redistribution and use in source and binary forms, with or without modification, are permitted provided that the following conditions are met:

1. Redistributions of source code must retain the above copyright notice, this list of conditions and the following disclaimer.
2. Redistributions in binary form must reproduce the above copyright notice, this list of conditions and the following disclaimer in the documentation and/or other materials provided with the distribution.
3. Neither the name of the University nor the names of its contributors may be used to endorse or promote products derived from this software without specific prior written permission.

THIS SOFTWARE IS PROVIDED BY THE REGENTS AND CONTRIBUTORS ` ` AS IS" AND ANY EXPRESS OR IMPLIED WARRANTIES, INCLUDING, BUT NOT LIMITED TO, THE IMPLIED WARRANTIES OF MERCHANTABILITY AND FITNESS FOR A PARTICULAR PURPOSE ARE DISCLAIMED. IN NO EVENT SHALL THE REGENTS OR CONTRIBUTORS BE LIABLE FOR ANY DIRECT, INDIRECT, INCIDENTAL, SPECIAL, EXEMPLARY, OR CONSEQUENTIAL DAMAGES (INCLUDING, BUT NOT LIMITED TO, PROCUREMENT OF SUBSTITUTE GOODS OR SERVICES; LOSS OF USE, DATA, OR PROFITS; OR BUSINESS INTERRUPTION) HOWEVER CAUSED AND ON ANY THEORY OF LIABILITY, WHETHER IN CONTRACT, STRICT LIABILITY, OR TORT (INCLUDING NEGLIGENCE OR OTHERWISE) ARISING IN ANY WAY OUT OF THE USE OF THIS SOFTWARE, EVEN IF ADVISED OF THE POSSIBILITY OF SUCH DAMAGE.

Copyright (c) 1992, 1993, 1994

The Regents of the University of California. All rights reserved.

Redistribution and use in source and binary forms, with or without modification, are permitted provided that the following conditions are met:

1. Redistributions of source code must retain the above copyright notice, this list of conditions and the following disclaimer.
2. Redistributions in binary form must reproduce the above copyright notice, this list of conditions and the following disclaimer in the documentation and/or other materials provided with the distribution.
3. Neither the name of the University nor the names of its contributors may be used to endorse or promote products derived from this software without specific prior written permission.

THIS SOFTWARE IS PROVIDED BY THE REGENTS AND CONTRIBUTORS ` ` AS IS" AND ANY



EXPRESS OR IMPLIED WARRANTIES, INCLUDING, BUT NOT LIMITED TO, THE IMPLIED WARRANTIES OF MERCHANTABILITY AND FITNESS FOR A PARTICULAR PURPOSE ARE DISCLAIMED. IN NO EVENT SHALL THE REGENTS OR CONTRIBUTORS BE LIABLE FOR ANY DIRECT, INDIRECT, INCIDENTAL, SPECIAL, EXEMPLARY, OR CONSEQUENTIAL DAMAGES (INCLUDING, BUT NOT LIMITED TO, PROCUREMENT OF SUBSTITUTE GOODS OR SERVICES; LOSS OF USE, DATA, OR PROFITS; OR BUSINESS INTERRUPTION) HOWEVER CAUSED AND ON ANY THEORY OF LIABILITY, WHETHER IN CONTRACT, STRICT LIABILITY, OR TORT (INCLUDING NEGLIGENCE OR OTHERWISE) ARISING IN ANY WAY OUT OF THE USE OF THIS SOFTWARE, EVEN IF ADVISED OF THE POSSIBILITY OF SUCH DAMAGE.

Copyright (c) 1997, 1998, 1999, 2002 The NetBSD Foundation, Inc.

All rights reserved.

This code is derived from software contributed to The NetBSD Foundation by Jason R. Thorpe of the Numerical Aerospace Simulation Facility, NASA Ames Research Center, by Luke Mewburn and by Tomas Svensson.

Redistribution and use in source and binary forms, with or without modification, are permitted provided that the following conditions are met:

1. Redistributions of source code must retain the above copyright notice, this list of conditions and the following disclaimer.
2. Redistributions in binary form must reproduce the above copyright notice, this list of conditions and the following disclaimer in the documentation and/or other materials provided with the distribution.

THIS SOFTWARE IS PROVIDED BY THE NETBSD FOUNDATION, INC. AND CONTRIBUTORS ``AS IS'' AND ANY EXPRESS OR IMPLIED WARRANTIES, INCLUDING, BUT NOT LIMITED TO, THE IMPLIED WARRANTIES OF MERCHANTABILITY AND FITNESS FOR A PARTICULAR PURPOSE ARE DISCLAIMED. IN NO EVENT SHALL THE FOUNDATION OR CONTRIBUTORS BE LIABLE FOR ANY DIRECT, INDIRECT, INCIDENTAL, SPECIAL, EXEMPLARY, OR CONSEQUENTIAL DAMAGES (INCLUDING, BUT NOT LIMITED TO, PROCUREMENT OF SUBSTITUTE GOODS OR SERVICES; LOSS OF USE, DATA, OR PROFITS; OR BUSINESS INTERRUPTION) HOWEVER CAUSED AND ON ANY THEORY OF LIABILITY, WHETHER IN CONTRACT, STRICT LIABILITY, OR TORT (INCLUDING NEGLIGENCE OR OTHERWISE) ARISING IN ANY WAY OUT OF THE USE OF THIS SOFTWARE, EVEN IF ADVISED OF THE POSSIBILITY OF SUCH DAMAGE.

Copyright (c) 1998 Robert Nordier

All rights reserved.

Redistribution and use in source and binary forms, with or without modification, are permitted provided that the following conditions are met:

1. Redistributions of source code must retain the above copyright notice, this list of conditions and the following disclaimer.
2. Redistributions in binary form must reproduce the above copyright notice, this list of conditions and the following disclaimer in the documentation and/or other materials provided with the distribution.

THIS SOFTWARE IS PROVIDED BY THE AUTHOR(S) ``AS IS'' AND ANY EXPRESS OR



IMPLIED WARRANTIES, INCLUDING, BUT NOT LIMITED TO, THE IMPLIED WARRANTIES OF MERCHANTABILITY AND FITNESS FOR A PARTICULAR PURPOSE ARE DISCLAIMED. IN NO EVENT SHALL THE AUTHOR(S) BE LIABLE FOR ANY DIRECT, INDIRECT, INCIDENTAL, SPECIAL, EXEMPLARY, OR CONSEQUENTIAL DAMAGES (INCLUDING, BUT NOT LIMITED TO, PROCUREMENT OF SUBSTITUTE GOODS OR SERVICES; LOSS OF USE, DATA, OR PROFITS; OR BUSINESS INTERRUPTION) HOWEVER CAUSED AND ON ANY THEORY OF LIABILITY, WHETHER IN CONTRACT, STRICT LIABILITY, OR TORT (INCLUDING NEGLIGENCE OR OTHERWISE) ARISING IN ANY WAY OUT OF THE USE OF THIS SOFTWARE, EVEN IF ADVISED OF THE POSSIBILITY OF SUCH DAMAGE.

Copyright (c) 1999 James Howard and Dag-Erling Coïdan Smørgrav

All rights reserved.

Redistribution and use in source and binary forms, with or without modification, are permitted provided that the following conditions are met:

1. Redistributions of source code must retain the above copyright notice, this list of conditions and the following disclaimer.
2. Redistributions in binary form must reproduce the above copyright notice, this list of conditions and the following disclaimer in the documentation and/or other materials provided with the distribution.

THIS SOFTWARE IS PROVIDED BY THE AUTHOR AND CONTRIBUTORS ``AS IS'' AND ANY EXPRESS OR IMPLIED WARRANTIES, INCLUDING, BUT NOT LIMITED TO, THE IMPLIED WARRANTIES OF MERCHANTABILITY AND FITNESS FOR A PARTICULAR PURPOSE ARE DISCLAIMED. IN NO EVENT SHALL THE AUTHOR OR CONTRIBUTORS BE LIABLE FOR ANY DIRECT, INDIRECT, INCIDENTAL, SPECIAL, EXEMPLARY, OR CONSEQUENTIAL DAMAGES (INCLUDING, BUT NOT LIMITED TO, PROCUREMENT OF SUBSTITUTE GOODS OR SERVICES; LOSS OF USE, DATA, OR PROFITS; OR BUSINESS INTERRUPTION) HOWEVER CAUSED AND ON ANY THEORY OF LIABILITY, WHETHER IN CONTRACT, STRICT LIABILITY, OR TORT (INCLUDING NEGLIGENCE OR OTHERWISE) ARISING IN ANY WAY OUT OF THE USE OF THIS SOFTWARE, EVEN IF ADVISED OF THE POSSIBILITY OF SUCH DAMAGE.

Copyright (c) 1999 James Howard and Dag-Erling Coïdan Smørgrav

Copyright (C) 2008 Gabor Kovesdan <gabor@FreeBSD.org>

All rights reserved.

Redistribution and use in source and binary forms, with or without modification, are permitted provided that the following conditions are met:

1. Redistributions of source code must retain the above copyright notice, this list of conditions and the following disclaimer.
2. Redistributions in binary form must reproduce the above copyright notice, this list of conditions and the following disclaimer in the documentation and/or other materials provided with the distribution.

THIS SOFTWARE IS PROVIDED BY THE AUTHOR AND CONTRIBUTORS ``AS IS'' AND ANY EXPRESS OR IMPLIED WARRANTIES, INCLUDING, BUT NOT LIMITED TO, THE IMPLIED WARRANTIES OF MERCHANTABILITY AND FITNESS FOR A PARTICULAR PURPOSE ARE



DISCLAIMED. IN NO EVENT SHALL THE AUTHOR OR CONTRIBUTORS BE LIABLE FOR ANY DIRECT, INDIRECT, INCIDENTAL, SPECIAL, EXEMPLARY, OR CONSEQUENTIAL DAMAGES (INCLUDING, BUT NOT LIMITED TO, PROCUREMENT OF SUBSTITUTE GOODS OR SERVICES; LOSS OF USE, DATA, OR PROFITS; OR BUSINESS INTERRUPTION) HOWEVER CAUSED AND ON ANY THEORY OF LIABILITY, WHETHER IN CONTRACT, STRICT LIABILITY, OR TORT (INCLUDING NEGLIGENCE OR OTHERWISE) ARISING IN ANY WAY OUT OF THE USE OF THIS SOFTWARE, EVEN IF ADVISED OF THE POSSIBILITY OF SUCH DAMAGE.

Copyright (c) 1999 James Howard and Dag-Erling Coïdan Smørgrav

Copyright (C) 2008-2009 Gabor Kovesdan <gabor@FreeBSD.org>

All rights reserved.

Redistribution and use in source and binary forms, with or without modification, are permitted provided that the following conditions are met:

1. Redistributions of source code must retain the above copyright notice, this list of conditions and the following disclaimer.
2. Redistributions in binary form must reproduce the above copyright notice, this list of conditions and the following disclaimer in the documentation and/or other materials provided with the distribution.

THIS SOFTWARE IS PROVIDED BY THE AUTHOR AND CONTRIBUTORS ``AS IS'' AND ANY EXPRESS OR IMPLIED WARRANTIES, INCLUDING, BUT NOT LIMITED TO, THE IMPLIED WARRANTIES OF MERCHANTABILITY AND FITNESS FOR A PARTICULAR PURPOSE ARE DISCLAIMED. IN NO EVENT SHALL THE AUTHOR OR CONTRIBUTORS BE LIABLE FOR ANY DIRECT, INDIRECT, INCIDENTAL, SPECIAL, EXEMPLARY, OR CONSEQUENTIAL DAMAGES (INCLUDING, BUT NOT LIMITED TO, PROCUREMENT OF SUBSTITUTE GOODS OR SERVICES; LOSS OF USE, DATA, OR PROFITS; OR BUSINESS INTERRUPTION) HOWEVER CAUSED AND ON ANY THEORY OF LIABILITY, WHETHER IN CONTRACT, STRICT LIABILITY, OR TORT (INCLUDING NEGLIGENCE OR OTHERWISE) ARISING IN ANY WAY OUT OF THE USE OF THIS SOFTWARE, EVEN IF ADVISED OF THE POSSIBILITY OF SUCH DAMAGE.

Copyright (c) 1999 James Howard and Dag-Erling Coïdan Smørgrav

Copyright (C) 2008-2010 Gabor Kovesdan <gabor@FreeBSD.org>

All rights reserved.

Redistribution and use in source and binary forms, with or without modification, are permitted provided that the following conditions are met:

1. Redistributions of source code must retain the above copyright notice, this list of conditions and the following disclaimer.
2. Redistributions in binary form must reproduce the above copyright notice, this list of conditions and the following disclaimer in the documentation and/or other materials provided with the distribution.

THIS SOFTWARE IS PROVIDED BY THE AUTHOR AND CONTRIBUTORS ``AS IS'' AND ANY EXPRESS OR IMPLIED WARRANTIES, INCLUDING, BUT NOT LIMITED TO, THE IMPLIED WARRANTIES OF MERCHANTABILITY AND FITNESS FOR A PARTICULAR PURPOSE ARE DISCLAIMED. IN NO EVENT SHALL THE AUTHOR OR CONTRIBUTORS BE LIABLE FOR ANY



DIRECT, INDIRECT, INCIDENTAL, SPECIAL, EXEMPLARY, OR CONSEQUENTIAL DAMAGES (INCLUDING, BUT NOT LIMITED TO, PROCUREMENT OF SUBSTITUTE GOODS OR SERVICES; LOSS OF USE, DATA, OR PROFITS; OR BUSINESS INTERRUPTION) HOWEVER CAUSED AND ON ANY THEORY OF LIABILITY, WHETHER IN CONTRACT, STRICT LIABILITY, OR TORT (INCLUDING NEGLIGENCE OR OTHERWISE) ARISING IN ANY WAY OUT OF THE USE OF THIS SOFTWARE, EVEN IF ADVISED OF THE POSSIBILITY OF SUCH DAMAGE.

Copyright (c) 1999 James Howard and Dag-Erling Coïdan Smørgrav

Copyright (C) 2008-2010 Gabor Kovesdan <gabor@FreeBSD.org>

Copyright (C) 2010 Dimitry Andric <dimitry@andric.com>

All rights reserved.

Redistribution and use in source and binary forms, with or without modification, are permitted provided that the following conditions are met:

1. Redistributions of source code must retain the above copyright notice, this list of conditions and the following disclaimer.
2. Redistributions in binary form must reproduce the above copyright notice, this list of conditions and the following disclaimer in the documentation and/or other materials provided with the distribution.

THIS SOFTWARE IS PROVIDED BY THE AUTHOR AND CONTRIBUTORS ``AS IS'' AND ANY EXPRESS OR IMPLIED WARRANTIES, INCLUDING, BUT NOT LIMITED TO, THE IMPLIED WARRANTIES OF MERCHANTABILITY AND FITNESS FOR A PARTICULAR PURPOSE ARE DISCLAIMED. IN NO EVENT SHALL THE AUTHOR OR CONTRIBUTORS BE LIABLE FOR ANY DIRECT, INDIRECT, INCIDENTAL, SPECIAL, EXEMPLARY, OR CONSEQUENTIAL DAMAGES (INCLUDING, BUT NOT LIMITED TO, PROCUREMENT OF SUBSTITUTE GOODS OR SERVICES; LOSS OF USE, DATA, OR PROFITS; OR BUSINESS INTERRUPTION) HOWEVER CAUSED AND ON ANY THEORY OF LIABILITY, WHETHER IN CONTRACT, STRICT LIABILITY, OR TORT (INCLUDING NEGLIGENCE OR OTHERWISE) ARISING IN ANY WAY OUT OF THE USE OF THIS SOFTWARE, EVEN IF ADVISED OF THE POSSIBILITY OF SUCH DAMAGE.

Copyright (c) 1999 James Howard and Dag-Erling Coïdan Smørgrav

Copyright (c) 2008-2009 Gabor Kovesdan <gabor@FreeBSD.org>

All rights reserved.

Redistribution and use in source and binary forms, with or without modification, are permitted provided that the following conditions are met:

1. Redistributions of source code must retain the above copyright notice, this list of conditions and the following disclaimer.
2. Redistributions in binary form must reproduce the above copyright notice, this list of conditions and the following disclaimer in the documentation and/or other materials provided with the distribution.

THIS SOFTWARE IS PROVIDED BY THE AUTHOR AND CONTRIBUTORS ``AS IS'' AND ANY EXPRESS OR IMPLIED WARRANTIES, INCLUDING, BUT NOT LIMITED TO, THE IMPLIED WARRANTIES OF MERCHANTABILITY AND FITNESS FOR A PARTICULAR PURPOSE ARE DISCLAIMED. IN NO EVENT SHALL THE AUTHOR OR CONTRIBUTORS BE LIABLE FOR ANY



DIRECT, INDIRECT, INCIDENTAL, SPECIAL, EXEMPLARY, OR CONSEQUENTIAL DAMAGES (INCLUDING, BUT NOT LIMITED TO, PROCUREMENT OF SUBSTITUTE GOODS OR SERVICES; LOSS OF USE, DATA, OR PROFITS; OR BUSINESS INTERRUPTION) HOWEVER CAUSED AND ON ANY THEORY OF LIABILITY, WHETHER IN CONTRACT, STRICT LIABILITY, OR TORT (INCLUDING NEGLIGENCE OR OTHERWISE) ARISING IN ANY WAY OUT OF THE USE OF THIS SOFTWARE, EVEN IF ADVISED OF THE POSSIBILITY OF SUCH DAMAGE.

Copyright (c) 2001-2002,2004 The NetBSD Foundation, Inc.

All rights reserved.

This code is derived from software contributed to The NetBSD Foundation by Luke Mewburn. Redistribution and use in source and binary forms, with or without modification, are permitted provided that the following conditions are met:

1. Redistributions of source code must retain the above copyright notice, this list of conditions and the following disclaimer.
2. Redistributions in binary form must reproduce the above copyright notice, this list of conditions and the following disclaimer in the documentation and/or other materials provided with the distribution.

THIS SOFTWARE IS PROVIDED BY THE NETBSD FOUNDATION, INC. AND CONTRIBUTORS ``AS IS'' AND ANY EXPRESS OR IMPLIED WARRANTIES, INCLUDING, BUT NOT LIMITED TO, THE IMPLIED WARRANTIES OF MERCHANTABILITY AND FITNESS FOR A PARTICULAR PURPOSE ARE DISCLAIMED. IN NO EVENT SHALL THE FOUNDATION OR CONTRIBUTORS BE LIABLE FOR ANY DIRECT, INDIRECT, INCIDENTAL, SPECIAL, EXEMPLARY, OR CONSEQUENTIAL DAMAGES (INCLUDING, BUT NOT LIMITED TO, PROCUREMENT OF SUBSTITUTE GOODS OR SERVICES; LOSS OF USE, DATA, OR PROFITS; OR BUSINESS INTERRUPTION) HOWEVER CAUSED AND ON ANY THEORY OF LIABILITY, WHETHER IN CONTRACT, STRICT LIABILITY, OR TORT (INCLUDING NEGLIGENCE OR OTHERWISE) ARISING IN ANY WAY OUT OF THE USE OF THIS SOFTWARE, EVEN IF ADVISED OF THE POSSIBILITY OF SUCH DAMAGE.

Copyright (c) 2007 The NetBSD Foundation, Inc.

All rights reserved.

This code is derived from software contributed to The NetBSD Foundation by Luke Mewburn. Redistribution and use in source and binary forms, with or without modification, are permitted provided that the following conditions are met:

1. Redistributions of source code must retain the above copyright notice, this list of conditions and the following disclaimer.
2. Redistributions in binary form must reproduce the above copyright notice, this list of conditions and the following disclaimer in the documentation and/or other materials provided with the distribution.

THIS SOFTWARE IS PROVIDED BY THE NETBSD FOUNDATION, INC. AND CONTRIBUTORS ``AS IS'' AND ANY EXPRESS OR IMPLIED WARRANTIES, INCLUDING, BUT NOT LIMITED TO, THE IMPLIED WARRANTIES OF MERCHANTABILITY AND FITNESS FOR A PARTICULAR PURPOSE ARE DISCLAIMED. IN NO EVENT SHALL THE FOUNDATION OR CONTRIBUTORS BE LIABLE FOR ANY DIRECT, INDIRECT, INCIDENTAL, SPECIAL, EXEMPLARY, OR CONSEQUENTIAL



DAMAGES (INCLUDING, BUT NOT LIMITED TO, PROCUREMENT OF SUBSTITUTE GOODS OR SERVICES; LOSS OF USE, DATA, OR PROFITS; OR BUSINESS INTERRUPTION) HOWEVER CAUSED AND ON ANY THEORY OF LIABILITY, WHETHER IN CONTRACT, STRICT LIABILITY, OR TORT (INCLUDING NEGLIGENCE OR OTHERWISE) ARISING IN ANY WAY OUT OF THE USE OF THIS SOFTWARE, EVEN IF ADVISED OF THE POSSIBILITY OF SUCH DAMAGE.

Copyright (c) 2008, The Android Open Source Project

All rights reserved.

Redistribution and use in source and binary forms, with or without modification, are permitted provided that the following conditions are met:

- * Redistributions of source code must retain the above copyright notice, this list of conditions and the following disclaimer.

- * Redistributions in binary form must reproduce the above copyright notice, this list of conditions and the following disclaimer in the documentation and/or other materials provided with the distribution.

- * Neither the name of Google, Inc. nor the names of its contributors may be used to endorse or promote products derived from this software without specific prior written permission.

THIS SOFTWARE IS PROVIDED BY THE COPYRIGHT HOLDERS AND CONTRIBUTORS "AS IS" AND ANY EXPRESS OR IMPLIED WARRANTIES, INCLUDING, BUT NOT LIMITED TO, THE IMPLIED WARRANTIES OF MERCHANTABILITY AND FITNESS FOR A PARTICULAR PURPOSE ARE DISCLAIMED. IN NO EVENT SHALL THE COPYRIGHT OWNER OR CONTRIBUTORS BE LIABLE FOR ANY DIRECT, INDIRECT, INCIDENTAL, SPECIAL, EXEMPLARY, OR CONSEQUENTIAL DAMAGES (INCLUDING, BUT NOT LIMITED TO, PROCUREMENT OF SUBSTITUTE GOODS OR SERVICES; LOSS OF USE, DATA, OR PROFITS; OR BUSINESS INTERRUPTION) HOWEVER CAUSED AND ON ANY THEORY OF LIABILITY, WHETHER IN CONTRACT, STRICT LIABILITY, OR TORT (INCLUDING NEGLIGENCE OR OTHERWISE) ARISING IN ANY WAY OUT OF THE USE OF THIS SOFTWARE, EVEN IF ADVISED OF THE POSSIBILITY OF SUCH DAMAGE.

Copyright (c) 2009, The Android Open Source Project

All rights reserved.

Redistribution and use in source and binary forms, with or without modification, are permitted provided that the following conditions are met:

- * Redistributions of source code must retain the above copyright notice, this list of conditions and the following disclaimer.

- * Redistributions in binary form must reproduce the above copyright notice, this list of conditions and the following disclaimer in the documentation and/or other materials provided with the distribution.

- * Neither the name of Google, Inc. nor the names of its contributors may be used to endorse or promote products derived from this software without specific prior written permission.

THIS SOFTWARE IS PROVIDED BY THE COPYRIGHT HOLDERS AND CONTRIBUTORS "AS IS" AND ANY EXPRESS OR IMPLIED WARRANTIES, INCLUDING, BUT NOT LIMITED TO, THE IMPLIED WARRANTIES OF MERCHANTABILITY AND FITNESS FOR A PARTICULAR PURPOSE ARE DISCLAIMED. IN NO EVENT SHALL THE COPYRIGHT OWNER OR CONTRIBUTORS BE



LIABLE FOR ANY DIRECT, INDIRECT, INCIDENTAL, SPECIAL, EXEMPLARY, OR CONSEQUENTIAL DAMAGES (INCLUDING, BUT NOT LIMITED TO, PROCUREMENT OF SUBSTITUTE GOODS OR SERVICES; LOSS OF USE, DATA, OR PROFITS; OR BUSINESS INTERRUPTION) HOWEVER CAUSED AND ON ANY THEORY OF LIABILITY, WHETHER IN CONTRACT, STRICT LIABILITY, OR TORT (INCLUDING NEGLIGENCE OR OTHERWISE) ARISING IN ANY WAY OUT OF THE USE OF THIS SOFTWARE, EVEN IF ADVISED OF THE POSSIBILITY OF SUCH DAMAGE.

Copyright (c) 2010 The NetBSD Foundation, Inc.

All rights reserved.

Redistribution and use in source and binary forms, with or without modification, are permitted provided that the following conditions are met:

1. Redistributions of source code must retain the above copyright notice, this list of conditions and the following disclaimer.
2. Redistributions in binary form must reproduce the above copyright notice, this list of conditions and the following disclaimer in the documentation and/or other materials provided with the distribution.

THIS SOFTWARE IS PROVIDED BY THE NETBSD FOUNDATION, INC. AND CONTRIBUTORS "AS IS" AND ANY EXPRESS OR IMPLIED WARRANTIES, INCLUDING, BUT NOT LIMITED TO, THE IMPLIED WARRANTIES OF MERCHANTABILITY AND FITNESS FOR A PARTICULAR PURPOSE ARE DISCLAIMED. IN NO EVENT SHALL THE FOUNDATION OR CONTRIBUTORS BE LIABLE FOR ANY DIRECT, INDIRECT, INCIDENTAL, SPECIAL, EXEMPLARY, OR CONSEQUENTIAL DAMAGES (INCLUDING, BUT NOT LIMITED TO, PROCUREMENT OF SUBSTITUTE GOODS OR SERVICES; LOSS OF USE, DATA, OR PROFITS; OR BUSINESS INTERRUPTION) HOWEVER CAUSED AND ON ANY THEORY OF LIABILITY, WHETHER IN CONTRACT, STRICT LIABILITY, OR TORT (INCLUDING NEGLIGENCE OR OTHERWISE) ARISING IN ANY WAY OUT OF THE USE OF THIS SOFTWARE, EVEN IF ADVISED OF THE POSSIBILITY OF SUCH DAMAGE.

Copyright (c) 2010, The Android Open Source Project

All rights reserved.

Redistribution and use in source and binary forms, with or without modification, are permitted provided that the following conditions are met:

- * Redistributions of source code must retain the above copyright notice, this list of conditions and the following disclaimer.
- * Redistributions in binary form must reproduce the above copyright notice, this list of conditions and the following disclaimer in the documentation and/or other materials provided with the distribution.
- * Neither the name of Google, Inc. nor the names of its contributors may be used to endorse or promote products derived from this software without specific prior written permission.

THIS SOFTWARE IS PROVIDED BY THE COPYRIGHT HOLDERS AND CONTRIBUTORS "AS IS" AND ANY EXPRESS OR IMPLIED WARRANTIES, INCLUDING, BUT NOT LIMITED TO, THE IMPLIED WARRANTIES OF MERCHANTABILITY AND FITNESS FOR A PARTICULAR PURPOSE ARE DISCLAIMED. IN NO EVENT SHALL THE COPYRIGHT OWNER OR CONTRIBUTORS BE LIABLE FOR ANY DIRECT, INDIRECT, INCIDENTAL, SPECIAL, EXEMPLARY, OR CONSEQUENTIAL



DAMAGES (INCLUDING, BUT NOT LIMITED TO, PROCUREMENT OF SUBSTITUTE GOODS OR SERVICES; LOSS OF USE, DATA, OR PROFITS; OR BUSINESS INTERRUPTION) HOWEVER CAUSED AND ON ANY THEORY OF LIABILITY, WHETHER IN CONTRACT, STRICT LIABILITY, OR TORT (INCLUDING NEGLIGENCE OR OTHERWISE) ARISING IN ANY WAY OUT OF THE USE OF THIS SOFTWARE, EVEN IF ADVISED OF THE POSSIBILITY OF SUCH DAMAGE.

Copyright (c) 2012, The Android Open Source Project

All rights reserved.

Redistribution and use in source and binary forms, with or without modification, are permitted provided that the following conditions are met:

- * Redistributions of source code must retain the above copyright notice, this list of conditions and the following disclaimer.
- * Redistributions in binary form must reproduce the above copyright notice, this list of conditions and the following disclaimer in the documentation and/or other materials provided with the distribution.
- * Neither the name of Google, Inc. nor the names of its contributors may be used to endorse or promote products derived from this software without specific prior written permission.

THIS SOFTWARE IS PROVIDED BY THE COPYRIGHT HOLDERS AND CONTRIBUTORS "AS IS" AND ANY EXPRESS OR IMPLIED WARRANTIES, INCLUDING, BUT NOT LIMITED TO, THE IMPLIED WARRANTIES OF MERCHANTABILITY AND FITNESS FOR A PARTICULAR PURPOSE ARE DISCLAIMED. IN NO EVENT SHALL THE COPYRIGHT OWNER OR CONTRIBUTORS BE LIABLE FOR ANY DIRECT, INDIRECT, INCIDENTAL, SPECIAL, EXEMPLARY, OR CONSEQUENTIAL DAMAGES (INCLUDING, BUT NOT LIMITED TO, PROCUREMENT OF SUBSTITUTE GOODS OR SERVICES; LOSS OF USE, DATA, OR PROFITS; OR BUSINESS INTERRUPTION) HOWEVER CAUSED AND ON ANY THEORY OF LIABILITY, WHETHER IN CONTRACT, STRICT LIABILITY, OR TORT (INCLUDING NEGLIGENCE OR OTHERWISE) ARISING IN ANY WAY OUT OF THE USE OF THIS SOFTWARE, EVEN IF ADVISED OF THE POSSIBILITY OF SUCH DAMAGE.

Copyright (c) 2013, The Android Open Source Project

All rights reserved.

Redistribution and use in source and binary forms, with or without modification, are permitted provided that the following conditions are met:

- * Redistributions of source code must retain the above copyright notice, this list of conditions and the following disclaimer.
- * Redistributions in binary form must reproduce the above copyright notice, this list of conditions and the following disclaimer in the documentation and/or other materials provided with the distribution.
- * Neither the name of Google, Inc. nor the names of its contributors may be used to endorse or promote products derived from this software without specific prior written permission.

THIS SOFTWARE IS PROVIDED BY THE COPYRIGHT HOLDERS AND CONTRIBUTORS "AS IS" AND ANY EXPRESS OR IMPLIED WARRANTIES, INCLUDING, BUT NOT LIMITED TO, THE IMPLIED WARRANTIES OF MERCHANTABILITY AND FITNESS FOR A PARTICULAR PURPOSE ARE DISCLAIMED. IN NO EVENT SHALL THE COPYRIGHT OWNER OR CONTRIBUTORS BE



LIABLE FOR ANY DIRECT, INDIRECT, INCIDENTAL, SPECIAL, EXEMPLARY, OR CONSEQUENTIAL DAMAGES (INCLUDING, BUT NOT LIMITED TO, PROCUREMENT OF SUBSTITUTE GOODS OR SERVICES; LOSS OF USE, DATA, OR PROFITS; OR BUSINESS INTERRUPTION) HOWEVER CAUSED AND ON ANY THEORY OF LIABILITY, WHETHER IN CONTRACT, STRICT LIABILITY, OR TORT (INCLUDING NEGLIGENCE OR OTHERWISE) ARISING IN ANY WAY OUT OF THE USE OF THIS SOFTWARE, EVEN IF ADVISED OF THE POSSIBILITY OF SUCH DAMAGE.

Copyright (c) 2014, The Android Open Source Project

All rights reserved.

Redistribution and use in source and binary forms, with or without modification, are permitted provided that the following conditions are met:

* Redistributions of source code must retain the above copyright notice, this list of conditions and the following disclaimer.

* Redistributions in binary form must reproduce the above copyright notice, this list of conditions and the following disclaimer in the documentation and/or other materials provided with the distribution.

* Neither the name of Google, Inc. nor the names of its contributors may be used to endorse or promote products derived from this software without specific prior written permission.

THIS SOFTWARE IS PROVIDED BY THE COPYRIGHT HOLDERS AND CONTRIBUTORS "AS IS" AND ANY EXPRESS OR IMPLIED WARRANTIES, INCLUDING, BUT NOT LIMITED TO, THE IMPLIED WARRANTIES OF MERCHANTABILITY AND FITNESS FOR A PARTICULAR PURPOSE ARE DISCLAIMED. IN NO EVENT SHALL THE COPYRIGHT OWNER OR CONTRIBUTORS BE LIABLE FOR ANY DIRECT, INDIRECT, INCIDENTAL, SPECIAL, EXEMPLARY, OR CONSEQUENTIAL DAMAGES (INCLUDING, BUT NOT LIMITED TO, PROCUREMENT OF SUBSTITUTE GOODS OR SERVICES; LOSS OF USE, DATA, OR PROFITS; OR BUSINESS INTERRUPTION) HOWEVER CAUSED AND ON ANY THEORY OF LIABILITY, WHETHER IN CONTRACT, STRICT LIABILITY, OR TORT (INCLUDING NEGLIGENCE OR OTHERWISE) ARISING IN ANY WAY OUT OF THE USE OF THIS SOFTWARE, EVEN IF ADVISED OF THE POSSIBILITY OF SUCH DAMAGE.

BSD-like License (file)

Redistribution and use in source and binary forms, with or without modification, are permitted provided that the following conditions are met:

1. Redistributions of source code must retain the above copyright notice immediately at the beginning of the file, without modification, this list of conditions, and the following disclaimer.
2. Redistributions in binary form must reproduce the above copyright notice, this list of conditions and the following disclaimer in the documentation and/or other materials provided with the distribution.

THIS SOFTWARE IS PROVIDED BY THE AUTHOR AND CONTRIBUTORS ``AS IS" AND ANY EXPRESS OR IMPLIED WARRANTIES, INCLUDING, BUT NOT LIMITED TO, THE IMPLIED



WARRANTIES OF MERCHANTABILITY AND FITNESS FOR A PARTICULAR PURPOSE ARE DISCLAIMED. IN NO EVENT SHALL THE AUTHOR OR CONTRIBUTORS BE LIABLE FOR ANY DIRECT, INDIRECT, INCIDENTAL, SPECIAL, EXEMPLARY, OR CONSEQUENTIAL DAMAGES (INCLUDING, BUT NOT LIMITED TO, PROCUREMENT OF SUBSTITUTE GOODS OR SERVICES; LOSS OF USE, DATA, OR PROFITS; OR BUSINESS INTERRUPTION) HOWEVER CAUSED AND ON ANY THEORY OF LIABILITY, WHETHER IN CONTRACT, STRICT LIABILITY, OR TORT (INCLUDING NEGLIGENCE OR OTHERWISE) ARISING IN ANY WAY OUT OF THE USE OF THIS SOFTWARE, EVEN IF ADVISED OF THE POSSIBILITY OF SUCH DAMAGE.

BSD-like License (musl)

Copyright (C) 1993 by Sun Microsystems, Inc. All rights reserved.

Developed at SunPro, a Sun Microsystems, Inc. business.

Permission to use, copy, modify, and distribute this software is freely granted, provided that this notice is preserved.

BSD-like License (tcp-wrappers)

This material was originally written and compiled by Wietse Venema at Eindhoven University of Technology, The Netherlands, in 1990, 1991, 1992, 1993, 1994 and 1995.

Redistribution and use in source and binary forms are permitted provided that this entire copyright notice is duplicated in all such copies.

This software is provided "as is" and without any expressed or implied warranties, including, without limitation, the implied warranties of merchantability and fitness for any particular purpose.

BSL-1.0

Boost Software License - Version 1.0 - August 17th, 2003

Permission is hereby granted, free of charge, to any person or organization obtaining a copy of the software and accompanying documentation covered by this license (the "Software") to use, reproduce, display, distribute, execute, and transmit the Software, and to prepare derivative works of the Software, and to permit third-parties to whom the Software is furnished to do so, all subject to the following:

The copyright notices in the Software and this entire statement, including the above license



grant, this restriction and the following disclaimer, must be included in all copies of the Software, in whole or in part, and all derivative works of the Software, unless such copies or derivative works are solely in the form of machine-executable object code generated by a source language processor.

THE SOFTWARE IS PROVIDED "AS IS", WITHOUT WARRANTY OF ANY KIND, EXPRESS OR IMPLIED, INCLUDING BUT NOT LIMITED TO THE WARRANTIES OF MERCHANTABILITY, FITNESS FOR A PARTICULAR PURPOSE, TITLE AND NON-INFRINGEMENT. IN NO EVENT SHALL THE COPYRIGHT HOLDERS OR ANYONE DISTRIBUTING THE SOFTWARE BE LIABLE FOR ANY DAMAGES OR OTHER LIABILITY, WHETHER IN CONTRACT, TORT OR OTHERWISE, ARISING FROM, OUT OF OR IN CONNECTION WITH THE SOFTWARE OR THE USE OR OTHER DEALINGS IN THE SOFTWARE.

Bitstream Vera License

Copyright (c) 2003 by Bitstream, Inc. All Rights Reserved. Bitstream Vera is a trademark of Bitstream, Inc.

Permission is hereby granted, free of charge, to any person obtaining a copy of the fonts accompanying this license ("Fonts") and associated documentation files (the "Font Software"), to reproduce and distribute the Font Software, including without limitation the rights to use, copy, merge, publish, distribute, and/or sell copies of the Font Software, and to permit persons to whom the Font Software is furnished to do so, subject to the following conditions:

The above copyright and trademark notices and this permission notice shall be included in all copies of one or more of the Font Software typefaces.

The Font Software may be modified, altered, or added to, and in particular the designs of glyphs or characters in the Fonts may be modified and additional glyphs or characters may be added to the Fonts, only if the fonts are renamed to names not containing either the words "Bitstream" or the word "Vera".

This License becomes null and void to the extent applicable to Fonts or Font Software that has been modified and is distributed under the "Bitstream Vera" names.

The Font Software may be sold as part of a larger software package but no copy of one or more of the Font Software typefaces may be sold by itself.

THE FONT SOFTWARE IS PROVIDED "AS IS", WITHOUT WARRANTY OF ANY KIND, EXPRESS OR IMPLIED, INCLUDING BUT NOT LIMITED TO ANY WARRANTIES OF MERCHANTABILITY, FITNESS FOR A PARTICULAR PURPOSE AND NON-INFRINGEMENT OF COPYRIGHT, PATENT, TRADEMARK, OR OTHER RIGHT. IN NO EVENT SHALL BITSTREAM OR THE GNOME



FOUNDATION BE LIABLE FOR ANY CLAIM, DAMAGES OR OTHER LIABILITY, INCLUDING ANY GENERAL, SPECIAL, INDIRECT, INCIDENTAL, OR CONSEQUENTIAL DAMAGES, WHETHER IN AN ACTION OF CONTRACT, TORT OR OTHERWISE, ARISING FROM, OUT OF THE USE OR INABILITY TO USE THE FONT SOFTWARE OR FROM OTHER DEALINGS IN THE FONT SOFTWARE.

Except as contained in this notice, the names of Gnome, the Gnome Foundation, and Bitstream Inc., shall not be used in advertising or otherwise to promote the sale, use or other dealings in this Font Software without prior written authorization from the Gnome Foundation or Bitstream Inc., respectively. For further information, contact: fonts at gnome dot org.

CC-BY-SA-3.0

Creative Commons Attribution-ShareAlike 3.0 Unported

CREATIVE COMMONS CORPORATION IS NOT A LAW FIRM AND DOES NOT PROVIDE LEGAL SERVICES. DISTRIBUTION OF THIS LICENSE DOES NOT CREATE AN ATTORNEY-CLIENT RELATIONSHIP. CREATIVE COMMONS PROVIDES THIS INFORMATION ON AN "AS-IS" BASIS. CREATIVE COMMONS MAKES NO WARRANTIES REGARDING THE INFORMATION PROVIDED, AND DISCLAIMS LIABILITY FOR DAMAGES RESULTING FROM ITS USE.

License

THE WORK (AS DEFINED BELOW) IS PROVIDED UNDER THE TERMS OF THIS CREATIVE COMMONS PUBLIC LICENSE ("CCPL" OR "LICENSE"). THE WORK IS PROTECTED BY COPYRIGHT AND/OR OTHER APPLICABLE LAW. ANY USE OF THE WORK OTHER THAN AS AUTHORIZED UNDER THIS LICENSE OR COPYRIGHT LAW IS PROHIBITED.

BY EXERCISING ANY RIGHTS TO THE WORK PROVIDED HERE, YOU ACCEPT AND AGREE TO BE BOUND BY THE TERMS OF THIS LICENSE. TO THE EXTENT THIS LICENSE MAY BE CONSIDERED TO BE A CONTRACT, THE LICENSOR GRANTS YOU THE RIGHTS CONTAINED HERE IN CONSIDERATION OF YOUR ACCEPTANCE OF SUCH TERMS AND CONDITIONS.

1. Definitions

a. "Adaptation" means a work based upon the Work, or upon the Work and other pre-existing works, such as a translation, adaptation, derivative work, arrangement of music or other alterations of a literary or artistic work, or phonogram or performance and includes cinematographic adaptations or any other form in which the Work may be recast, transformed, or adapted including in any form recognizably derived from the original, except that a work that constitutes a Collection will not be considered an Adaptation for the purpose of this License. For the avoidance of doubt, where the Work is a musical work, performance or phonogram, the synchronization of the Work in timed-relation with a moving image



("synching") will be considered an Adaptation for the purpose of this License.

b. "Collection" means a collection of literary or artistic works, such as encyclopedias and anthologies, or performances, phonograms or broadcasts, or other works or subject matter other than works listed in Section 1(f) below, which, by reason of the selection and arrangement of their contents, constitute intellectual creations, in which the Work is included in its entirety in unmodified form along with one or more other contributions, each constituting separate and independent works in themselves, which together are assembled into a collective whole. A work that constitutes a Collection will not be considered an Adaptation (as defined below) for the purposes of this License.

c. "Creative Commons Compatible License" means a license that is listed at <http://creativecommons.org/compatiblelicenses> that has been approved by Creative Commons as being essentially equivalent to this License, including, at a minimum, because that license: (i) contains terms that have the same purpose, meaning and effect as the License Elements of this License; and, (ii) explicitly permits the relicensing of adaptations of works made available under that license under this License or a Creative Commons jurisdiction license with the same License Elements as this License.

d. "Distribute" means to make available to the public the original and copies of the Work or Adaptation, as appropriate, through sale or other transfer of ownership.

e. "License Elements" means the following high-level license attributes as selected by Licensor and indicated in the title of this License: Attribution, ShareAlike.

f. "Licensor" means the individual, individuals, entity or entities that offer(s) the Work under the terms of this License.

g. "Original Author" means, in the case of a literary or artistic work, the individual, individuals, entity or entities who created the Work or if no individual or entity can be identified, the publisher; and in addition (i) in the case of a performance the actors, singers, musicians, dancers, and other persons who act, sing, deliver, declaim, play in, interpret or otherwise perform literary or artistic works or expressions of folklore; (ii) in the case of a phonogram the producer being the person or legal entity who first fixes the sounds of a performance or other sounds; and, (iii) in the case of broadcasts, the organization that transmits the broadcast.

h. "Work" means the literary and/or artistic work offered under the terms of this License including without limitation any production in the literary, scientific and artistic domain, whatever may be the mode or form of its expression including digital form, such as a book, pamphlet and other writing; a lecture, address, sermon or other work of the same nature; a dramatic or dramatico-musical work; a choreographic work or entertainment in dumb show; a musical composition with or without words; a cinematographic work to which are assimilated works expressed by a process analogous to cinematography; a work of drawing,



painting, architecture, sculpture, engraving or lithography; a photographic work to which are assimilated works expressed by a process analogous to photography; a work of applied art; an illustration, map, plan, sketch or three-dimensional work relative to geography, topography, architecture or science; a performance; a broadcast; a phonogram; a compilation of data to the extent it is protected as a copyrightable work; or a work performed by a variety or circus performer to the extent it is not otherwise considered a literary or artistic work.

i. "You" means an individual or entity exercising rights under this License who has not previously violated the terms of this License with respect to the Work, or who has received express permission from the Licensor to exercise rights under this License despite a previous violation.

j. "Publicly Perform" means to perform public recitations of the Work and to communicate to the public those public recitations, by any means or process, including by wire or wireless means or public digital performances; to make available to the public Works in such a way that members of the public may access these Works from a place and at a place individually chosen by them; to perform the Work to the public by any means or process and the communication to the public of the performances of the Work, including by public digital performance; to broadcast and rebroadcast the Work by any means including signs, sounds or images.

k. "Reproduce" means to make copies of the Work by any means including without limitation by sound or visual recordings and the right of fixation and reproducing fixations of the Work, including storage of a protected performance or phonogram in digital form or other electronic medium.

2. Fair Dealing Rights. Nothing in this License is intended to reduce, limit, or restrict any uses free from copyright or rights arising from limitations or exceptions that are provided for in connection with the copyright protection under copyright law or other applicable laws.

3. License Grant. Subject to the terms and conditions of this License, Licensor hereby grants You a worldwide, royalty-free, non-exclusive, perpetual (for the duration of the applicable copyright) license to exercise the rights in the Work as stated below:

a. to Reproduce the Work, to incorporate the Work into one or more Collections, and to Reproduce the Work as incorporated in the Collections;

b. to create and Reproduce Adaptations provided that any such Adaptation, including any translation in any medium, takes reasonable steps to clearly label, demarcate or otherwise identify that changes were made to the original Work. For example, a translation could be marked "The original work was translated from English to Spanish," or a modification could indicate "The original work has been modified.";



- c. to Distribute and Publicly Perform the Work including as incorporated in Collections; and,
- d. to Distribute and Publicly Perform Adaptations.
- e. For the avoidance of doubt:

i. **Non-waivable Compulsory License Schemes.** In those jurisdictions in which the right to collect royalties through any statutory or compulsory licensing scheme cannot be waived, the Licensor reserves the exclusive right to collect such royalties for any exercise by You of the rights granted under this License;

ii. **Waivable Compulsory License Schemes.** In those jurisdictions in which the right to collect royalties through any statutory or compulsory licensing scheme can be waived, the Licensor waives the exclusive right to collect such royalties for any exercise by You of the rights granted under this License; and,

iii. **Voluntary License Schemes.** The Licensor waives the right to collect royalties, whether individually or, in the event that the Licensor is a member of a collecting society that administers voluntary licensing schemes, via that society, from any exercise by You of the rights granted under this License.

The above rights may be exercised in all media and formats whether now known or hereafter devised. The above rights include the right to make such modifications as are technically necessary to exercise the rights in other media and formats. Subject to Section 8(f), all rights not expressly granted by Licensor are hereby reserved.

4. **Restrictions.** The license granted in Section 3 above is expressly made subject to and limited by the following restrictions:

a. You may Distribute or Publicly Perform the Work only under the terms of this License. You must include a copy of, or the Uniform Resource Identifier (URI) for, this License with every copy of the Work You Distribute or Publicly Perform. You may not offer or impose any terms on the Work that restrict the terms of this License or the ability of the recipient of the Work to exercise the rights granted to that recipient under the terms of the License. You may not sublicense the Work. You must keep intact all notices that refer to this License and to the disclaimer of warranties with every copy of the Work You Distribute or Publicly Perform. When You Distribute or Publicly Perform the Work, You may not impose any effective technological measures on the Work that restrict the ability of a recipient of the Work from You to exercise the rights granted to that recipient under the terms of the License. This Section 4(a) applies to the Work as incorporated in a Collection, but this does not require the Collection apart from the Work itself to be made subject to the terms of this License. If You create a Collection, upon notice from any Licensor You must, to the extent practicable, remove from the Collection any credit as required by Section 4(c), as requested. If You create an Adaptation,



upon notice from any Licensor You must, to the extent practicable, remove from the Adaptation any credit as required by Section 4(c), as requested.

b. You may Distribute or Publicly Perform an Adaptation only under the terms of: (i) this License; (ii) a later version of this License with the same License Elements as this License; (iii) a Creative Commons jurisdiction license (either this or a later license version) that contains the same License Elements as this License (e.g., Attribution-ShareAlike 3.0 US)); (iv) a Creative Commons Compatible License. If you license the Adaptation under one of the licenses mentioned in (iv), you must comply with the terms of that license. If you license the Adaptation under the terms of any of the licenses mentioned in (i), (ii) or (iii) (the "Applicable License"), you must comply with the terms of the Applicable License generally and the following provisions: (I) You must include a copy of, or the URI for, the Applicable License with every copy of each Adaptation You Distribute or Publicly Perform; (II) You may not offer or impose any terms on the Adaptation that restrict the terms of the Applicable License or the ability of the recipient of the Adaptation to exercise the rights granted to that recipient under the terms of the Applicable License; (III) You must keep intact all notices that refer to the Applicable License and to the disclaimer of warranties with every copy of the Work as included in the Adaptation You Distribute or Publicly Perform; (IV) when You Distribute or Publicly Perform the Adaptation, You may not impose any effective technological measures on the Adaptation that restrict the ability of a recipient of the Adaptation from You to exercise the rights granted to that recipient under the terms of the Applicable License. This Section 4(b) applies to the Adaptation as incorporated in a Collection, but this does not require the Collection apart from the Adaptation itself to be made subject to the terms of the Applicable License.

c. If You Distribute, or Publicly Perform the Work or any Adaptations or Collections, You must, unless a request has been made pursuant to Section 4(a), keep intact all copyright notices for the Work and provide, reasonable to the medium or means You are utilizing: (i) the name of the Original Author (or pseudonym, if applicable) if supplied, and/or if the Original Author and/or Licensor designate another party or parties (e.g., a sponsor institute, publishing entity, journal) for attribution ("Attribution Parties") in Licensor's copyright notice, terms of service or by other reasonable means, the name of such party or parties; (ii) the title of the Work if supplied; (iii) to the extent reasonably practicable, the URI, if any, that Licensor specifies to be associated with the Work, unless such URI does not refer to the copyright notice or licensing information for the Work; and (iv) , consistent with Ssection 3(b), in the case of an Adaptation, a credit identifying the use of the Work in the Adaptation (e.g., "French translation of the Work by Original Author," or "Screenplay based on original Work by Original Author"). The credit required by this Section 4(c) may be implemented in any reasonable manner; provided, however, that in the case of a Adaptation or Collection, at a minimum such credit will appear, if a credit for all contributing authors of the Adaptation or Collection appears, then as part of these credits and in a manner at least as prominent as the credits for the other contributing authors. For the avoidance of doubt, You may only use the credit required by this Section for the purpose of attribution in the manner set out above and, by exercising Your rights under this License, You may not implicitly or explicitly assert or imply any connection with, sponsorship or endorsement by the Original Author, Licensor and/or Attribution Parties, as appropriate, of You or Your use of the Work, without the separate, express prior written



permission of the Original Author, Licensor and/or Attribution Parties.

d. Except as otherwise agreed in writing by the Licensor or as may be otherwise permitted by applicable law, if You Reproduce, Distribute or Publicly Perform the Work either by itself or as part of any Adaptations or Collections, You must not distort, mutilate, modify or take other derogatory action in relation to the Work which would be prejudicial to the Original Author's honor or reputation. Licensor agrees that in those jurisdictions (e.g. Japan), in which any exercise of the right granted in Section 3(b) of this License (the right to make Adaptations) would be deemed to be a distortion, mutilation, modification or other derogatory action prejudicial to the Original Author's honor and reputation, the Licensor will waive or not assert, as appropriate, this Section, to the fullest extent permitted by the applicable national law, to enable You to reasonably exercise Your right under Section 3(b) of this License (right to make Adaptations) but not otherwise.

5. Representations, Warranties and Disclaimer

UNLESS OTHERWISE MUTUALLY AGREED TO BY THE PARTIES IN WRITING, LICENSOR OFFERS THE WORK AS-IS AND MAKES NO REPRESENTATIONS OR WARRANTIES OF ANY KIND CONCERNING THE WORK, EXPRESS, IMPLIED, STATUTORY OR OTHERWISE, INCLUDING, WITHOUT LIMITATION, WARRANTIES OF TITLE, MERCHANTABILITY, FITNESS FOR A PARTICULAR PURPOSE, NONINFRINGEMENT, OR THE ABSENCE OF LATENT OR OTHER DEFECTS, ACCURACY, OR THE PRESENCE OF ABSENCE OF ERRORS, WHETHER OR NOT DISCOVERABLE. SOME JURISDICTIONS DO NOT ALLOW THE EXCLUSION OF IMPLIED WARRANTIES, SO SUCH EXCLUSION MAY NOT APPLY TO YOU.

6. Limitation on Liability. EXCEPT TO THE EXTENT REQUIRED BY APPLICABLE LAW, IN NO EVENT WILL LICENSOR BE LIABLE TO YOU ON ANY LEGAL THEORY FOR ANY SPECIAL, INCIDENTAL, CONSEQUENTIAL, PUNITIVE OR EXEMPLARY DAMAGES ARISING OUT OF THIS LICENSE OR THE USE OF THE WORK, EVEN IF LICENSOR HAS BEEN ADVISED OF THE POSSIBILITY OF SUCH DAMAGES.

7. Termination

a. This License and the rights granted hereunder will terminate automatically upon any breach by You of the terms of this License. Individuals or entities who have received Adaptations or Collections from You under this License, however, will not have their licenses terminated provided such individuals or entities remain in full compliance with those licenses. Sections 1, 2, 5, 6, 7, and 8 will survive any termination of this License.

b. Subject to the above terms and conditions, the license granted here is perpetual (for the duration of the applicable copyright in the Work). Notwithstanding the above, Licensor reserves the right to release the Work under different license terms or to stop distributing the Work at any time; provided, however that any such election will not serve to withdraw this License (or any other license that has been, or is required to be, granted under the terms of this License), and this License will continue in full force and effect unless terminated as stated



above.

8. Miscellaneous

a. Each time You Distribute or Publicly Perform the Work or a Collection, the Licensor offers to the recipient a license to the Work on the same terms and conditions as the license granted to You under this License.

b. Each time You Distribute or Publicly Perform an Adaptation, Licensor offers to the recipient a license to the original Work on the same terms and conditions as the license granted to You under this License.

c. If any provision of this License is invalid or unenforceable under applicable law, it shall not affect the validity or enforceability of the remainder of the terms of this License, and without further action by the parties to this agreement, such provision shall be reformed to the minimum extent necessary to make such provision valid and enforceable.

d. No term or provision of this License shall be deemed waived and no breach consented to unless such waiver or consent shall be in writing and signed by the party to be charged with such waiver or consent.

e. This License constitutes the entire agreement between the parties with respect to the Work licensed here. There are no understandings, agreements or representations with respect to the Work not specified here. Licensor shall not be bound by any additional provisions that may appear in any communication from You. This License may not be modified without the mutual written agreement of the Licensor and You.

f. The rights granted under, and the subject matter referenced, in this License were drafted utilizing the terminology of the Berne Convention for the Protection of Literary and Artistic Works (as amended on September 28, 1979), the Rome Convention of 1961, the WIPO Copyright Treaty of 1996, the WIPO Performances and Phonograms Treaty of 1996 and the Universal Copyright Convention (as revised on July 24, 1971). These rights and subject matter take effect in the relevant jurisdiction in which the License terms are sought to be enforced according to the corresponding provisions of the implementation of those treaty provisions in the applicable national law. If the standard suite of rights granted under applicable copyright law includes additional rights not granted under this License, such additional rights are deemed to be included in the License; this License is not intended to restrict the license of any rights under applicable law.

Creative Commons Notice

Creative Commons is not a party to this License, and makes no warranty whatsoever in



connection with the Work. Creative Commons will not be liable to You or any party on any legal theory for any damages whatsoever, including without limitation any general, special, incidental or consequential damages arising in connection to this license. Notwithstanding the foregoing two (2) sentences, if Creative Commons has expressly identified itself as the Licensor hereunder, it shall have all rights and obligations of Licensor.

Except for the limited purpose of indicating to the public that the Work is licensed under the CCPL, Creative Commons does not authorize the use by either party of the trademark "Creative Commons" or any related trademark or logo of Creative Commons without the prior written consent of Creative Commons. Any permitted use will be in compliance with Creative Commons' then-current trademark usage guidelines, as may be published on its website or otherwise made available upon request from time to time. For the avoidance of doubt, this trademark restriction does not form part of the License.

Creative Commons may be contacted at <http://creativecommons.org/>.

FTL

The FreeType Project LICENSE

2006-Jan-27

Copyright 1996-2002, 2006 by David Turner, Robert Wilhelm, and Werner Lemberg

Introduction

The FreeType Project is distributed in several archive packages; some of them may contain, in addition to the FreeType font engine, various tools and contributions which rely on, or relate to, the FreeType Project.

This license applies to all files found in such packages, and which do not fall under their own explicit license. The license affects thus the FreeType font engine, the test programs, documentation and makefiles, at the very least.

This license was inspired by the BSD, Artistic, and IJG (Independent JPEG Group) licenses, which all encourage inclusion and use of free software in commercial and freeware products alike. As a consequence, its main points are that:

- We don't promise that this software works. However, we will be interested in any kind of bug reports. (` as is' distribution)
- You can use this software for whatever you want, in parts or full form, without having to



pay us. (`royalty-free' usage)

- You may not pretend that you wrote this software. If you use it, or only parts of it, in a program, you must acknowledge somewhere in your documentation that you have used the FreeType code. (`credits')

We specifically permit and encourage the inclusion of this software, with or without modifications, in commercial products. We disclaim all warranties covering The FreeType Project and assume no liability related to The FreeType Project.

Finally, many people asked us for a preferred form for a credit/disclaimer to use in compliance with this license. We thus encourage you to use the following text:

"" Portions of this software are copyright © <year> The FreeType Project (www.freetype.org). All rights reserved. ""

Please replace <year> with the value from the FreeType version you actually use.

Legal Terms

0. Definitions

Throughout this license, the terms `package', `FreeType Project', and `FreeType archive' refer to the set of files originally distributed by the authors (David Turner, Robert Wilhelm, and Werner Lemberg) as the `FreeType Project', be they named as alpha, beta or final release.

`You' refers to the licensee, or person using the project, where `using' is a generic term including compiling the project's source code as well as linking it to form a `program' or `executable'. This program is referred to as `a program using the FreeType engine'.

This license applies to all files distributed in the original FreeType Project, including all source code, binaries and documentation, unless otherwise stated in the file in its original, unmodified form as distributed in the original archive. If you are unsure whether or not a particular file is covered by this license, you must contact us to verify this.

The FreeType Project is copyright (C) 1996-2000 by David Turner, Robert Wilhelm, and Werner Lemberg. All rights reserved except as specified below.

1. No Warranty

THE FREETYPE PROJECT IS PROVIDED `AS IS' WITHOUT WARRANTY OF ANY KIND, EITHER EXPRESS OR IMPLIED, INCLUDING, BUT NOT LIMITED TO, WARRANTIES OF



MERCHANTABILITY AND FITNESS FOR A PARTICULAR PURPOSE. IN NO EVENT WILL ANY OF THE AUTHORS OR COPYRIGHT HOLDERS BE LIABLE FOR ANY DAMAGES CAUSED BY THE USE OR THE INABILITY TO USE, OF THE FREETYPE PROJECT.

2. Redistribution

This license grants a worldwide, royalty-free, perpetual and irrevocable right and license to use, execute, perform, compile, display, copy, create derivative works of, distribute and sublicense the FreeType Project (in both source and object code forms) and derivative works thereof for any purpose; and to authorize others to exercise some or all of the rights granted herein, subject to the following conditions:

- Redistribution of source code must retain this license file (``FTL.TXT'`) unaltered; any additions, deletions or changes to the original files must be clearly indicated in accompanying documentation. The copyright notices of the unaltered, original files must be preserved in all copies of source files.
- Redistribution in binary form must provide a disclaimer that states that the software is based in part of the work of the FreeType Team, in the distribution documentation. We also encourage you to put an URL to the FreeType web page in your documentation, though this isn't mandatory.

These conditions apply to any software derived from or based on the FreeType Project, not just the unmodified files. If you use our work, you must acknowledge us. However, no fee need be paid to us.

3. Advertising

Neither the FreeType authors and contributors nor you shall use the name of the other for commercial, advertising, or promotional purposes without specific prior written permission.

We suggest, but do not require, that you use one or more of the following phrases to refer to this software in your documentation or advertising materials: ``FreeType Project'`, ``FreeType Engine'`, ``FreeType library'`, or ``FreeType Distribution'`.

As you have not signed this license, you are not required to accept it. However, as the FreeType Project is copyrighted material, only this license, or another one contracted with the authors, grants you the right to use, distribute, and modify it. Therefore, by using, distributing, or modifying the FreeType Project, you indicate that you understand and accept all the terms of this license.

4. Contacts



There are two mailing lists related to FreeType:

o freetype@nongnu.org

Discusses general use and applications of FreeType, as well as future and wanted additions to the library and distribution. If you are looking for support, start in this list if you haven't found anything to help you in the documentation.

o freetype-devel@nongnu.org

Discusses bugs, as well as engine internals, design issues, specific licenses, porting, etc.

Our home page can be found at

<http://www.freetype.org>

--- end of FTL.TXT ---

GNU General Public License v2.0 w/socat OpenSSL Exception

GNU GENERAL PUBLIC LICENSE

Version 2, June 1991

Copyright (C) 1989, 1991 Free Software Foundation, Inc.
51 Franklin Street, Fifth Floor, Boston, MA 02110-1301, USA

Everyone is permitted to copy and distribute verbatim copies of this license document, but changing it is not allowed.

Preamble

The licenses for most software are designed to take away your freedom to share and change it. By contrast, the GNU General Public License is intended to guarantee your freedom to share and change free software--to make sure the software is free for all its users. This General Public License applies to most of the Free Software Foundation's software and to any other program whose authors commit to using it. (Some other Free Software Foundation software is covered by the GNU Lesser General Public License instead.) You can apply it to your programs, too.



When we speak of free software, we are referring to freedom, not price. Our General Public Licenses are designed to make sure that you have the freedom to distribute copies of free software (and charge for this service if you wish), that you receive source code or can get it if you want it, that you can change the software or use pieces of it in new free programs; and that you know you can do these things.

To protect your rights, we need to make restrictions that forbid anyone to deny you these rights or to ask you to surrender the rights. These restrictions translate to certain responsibilities for you if you distribute copies of the software, or if you modify it.

For example, if you distribute copies of such a program, whether gratis or for a fee, you must give the recipients all the rights that you have. You must make sure that they, too, receive or can get the source code. And you must show them these terms so they know their rights.

We protect your rights with two steps: (1) copyright the software, and (2) offer you this license which gives you legal permission to copy, distribute and/or modify the software.

Also, for each author's protection and ours, we want to make certain that everyone understands that there is no warranty for this free software. If the software is modified by someone else and passed on, we want its recipients to know that what they have is not the original, so that any problems introduced by others will not reflect on the original authors' reputations.

Finally, any free program is threatened constantly by software patents. We wish to avoid the danger that redistributors of a free program will individually obtain patent licenses, in effect making the program proprietary. To prevent this, we have made it clear that any patent must be licensed for everyone's free use or not licensed at all.

The precise terms and conditions for copying, distribution and modification follow.

TERMS AND CONDITIONS FOR COPYING, DISTRIBUTION AND MODIFICATION

0. This License applies to any program or other work which contains a notice placed by the copyright holder saying it may be distributed under the terms of this General Public License. The "Program", below, refers to any such program or work, and a "work based on the Program" means either the Program or any derivative work under copyright law: that is to say, a work containing the Program or a portion of it, either verbatim or with modifications and/or translated into another language. (Hereinafter, translation is included without limitation in the term "modification".) Each licensee is addressed as "you".

Activities other than copying, distribution and modification are not covered by this License; they are outside its scope. The act of running the Program is not restricted, and the output



from the Program is covered only if its contents constitute a work based on the Program (independent of having been made by running the Program). Whether that is true depends on what the Program does.

1. You may copy and distribute verbatim copies of the Program's source code as you receive it, in any medium, provided that you conspicuously and appropriately publish on each copy an appropriate copyright notice and disclaimer of warranty; keep intact all the notices that refer to this License and to the absence of any warranty; and give any other recipients of the Program a copy of this License along with the Program.

You may charge a fee for the physical act of transferring a copy, and you may at your option offer warranty protection in exchange for a fee.

2. You may modify your copy or copies of the Program or any portion of it, thus forming a work based on the Program, and copy and distribute such modifications or work under the terms of Section 1 above, provided that you also meet all of these conditions:

a) You must cause the modified files to carry prominent notices stating that you changed the files and the date of any change.

b) You must cause any work that you distribute or publish, that in whole or in part contains or is derived from the Program or any part thereof, to be licensed as a whole at no charge to all third parties under the terms of this License.

c) If the modified program normally reads commands interactively when run, you must cause it, when started running for such interactive use in the most ordinary way, to print or display an announcement including an appropriate copyright notice and a notice that there is no warranty (or else, saying that you provide a warranty) and that users may redistribute the program under these conditions, and telling the user how to view a copy of this License. (Exception: if the Program itself is interactive but does not normally print such an announcement, your work based on the Program is not required to print an announcement.)

These requirements apply to the modified work as a whole. If identifiable sections of that work are not derived from the Program, and can be reasonably considered independent and separate works in themselves, then this License, and its terms, do not apply to those sections when you distribute them as separate works. But when you distribute the same sections as part of a whole which is a work based on the Program, the distribution of the whole must be on the terms of this License, whose permissions for other licensees extend to the entire whole, and thus to each and every part regardless of who wrote it.

Thus, it is not the intent of this section to claim rights or contest your rights to work written entirely by you; rather, the intent is to exercise the right to control the distribution of derivative or collective works based on the Program.



In addition, mere aggregation of another work not based on the Program with the Program (or with a work based on the Program) on a volume of a storage or distribution medium does not bring the other work under the scope of this License.

3. You may copy and distribute the Program (or a work based on it, under Section 2) in object code or executable form under the terms of Sections 1 and 2 above provided that you also do one of the following:

a) Accompany it with the complete corresponding machine-readable source code, which must be distributed under the terms of Sections 1 and 2 above on a medium customarily used for software interchange; or,

b) Accompany it with a written offer, valid for at least three years, to give any third party, for a charge no more than your cost of physically performing source distribution, a complete machine-readable copy of the corresponding source code, to be distributed under the terms of Sections 1 and 2 above on a medium customarily used for software interchange; or,

c) Accompany it with the information you received as to the offer to distribute corresponding source code. (This alternative is allowed only for noncommercial distribution and only if you received the program in object code or executable form with such an offer, in accord with Subsection b above.)

The source code for a work means the preferred form of the work for making modifications to it. For an executable work, complete source code means all the source code for all modules it contains, plus any associated interface definition files, plus the scripts used to control compilation and installation of the executable. However, as a special exception, the source code distributed need not include anything that is normally distributed (in either source or binary form) with the major components (compiler, kernel, and so on) of the operating system on which the executable runs, unless that component itself accompanies the executable.

If distribution of executable or object code is made by offering access to copy from a designated place, then offering equivalent access to copy the source code from the same place counts as distribution of the source code, even though third parties are not compelled to copy the source along with the object code.

4. You may not copy, modify, sublicense, or distribute the Program except as expressly provided under this License. Any attempt otherwise to copy, modify, sublicense or distribute the Program is void, and will automatically terminate your rights under this License. However, parties who have received copies, or rights, from you under this License will not have their licenses terminated so long as such parties remain in full compliance.

5. You are not required to accept this License, since you have not signed it. However, nothing



else grants you permission to modify or distribute the Program or its derivative works. These actions are prohibited by law if you do not accept this License. Therefore, by modifying or distributing the Program (or any work based on the Program), you indicate your acceptance of this License to do so, and all its terms and conditions for copying, distributing or modifying the Program or works based on it.

6. Each time you redistribute the Program (or any work based on the Program), the recipient automatically receives a license from the original licensor to copy, distribute or modify the Program subject to these terms and conditions. You may not impose any further restrictions on the recipients' exercise of the rights granted herein. You are not responsible for enforcing compliance by third parties to this License.

7. If, as a consequence of a court judgment or allegation of patent infringement or for any other reason (not limited to patent issues), conditions are imposed on you (whether by court order, agreement or otherwise) that contradict the conditions of this License, they do not excuse you from the conditions of this License. If you cannot distribute so as to satisfy simultaneously your obligations under this License and any other pertinent obligations, then as a consequence you may not distribute the Program at all. For example, if a patent license would not permit royalty-free redistribution of the Program by all those who receive copies directly or indirectly through you, then the only way you could satisfy both it and this License would be to refrain entirely from distribution of the Program.

If any portion of this section is held invalid or unenforceable under any particular circumstance, the balance of the section is intended to apply and the section as a whole is intended to apply in other circumstances.

It is not the purpose of this section to induce you to infringe any patents or other property right claims or to contest validity of any such claims; this section has the sole purpose of protecting the integrity of the free software distribution system, which is implemented by public license practices. Many people have made generous contributions to the wide range of software distributed through that system in reliance on consistent application of that system; it is up to the author/donor to decide if he or she is willing to distribute software through any other system and a licensee cannot impose that choice.

This section is intended to make thoroughly clear what is believed to be a consequence of the rest of this License.

8. If the distribution and/or use of the Program is restricted in certain countries either by patents or by copyrighted interfaces, the original copyright holder who places the Program under this License may add an explicit geographical distribution limitation excluding those countries, so that distribution is permitted only in or among countries not thus excluded. In such case, this License incorporates the limitation as if written in the body of this License.



9. The Free Software Foundation may publish revised and/or new versions of the General Public License from time to time. Such new versions will be similar in spirit to the present version, but may differ in detail to address new problems or concerns.

Each version is given a distinguishing version number. If the Program specifies a version number of this License which applies to it and "any later version", you have the option of following the terms and conditions either of that version or of any later version published by the Free Software Foundation. If the Program does not specify a version number of this License, you may choose any version ever published by the Free Software Foundation.

10. If you wish to incorporate parts of the Program into other free programs whose distribution conditions are different, write to the author to ask for permission. For software which is copyrighted by the Free Software Foundation, write to the Free Software Foundation; we sometimes make exceptions for this. Our decision will be guided by the two goals of preserving the free status of all derivatives of our free software and of promoting the sharing and reuse of software generally.

NO WARRANTY

11. BECAUSE THE PROGRAM IS LICENSED FREE OF CHARGE, THERE IS NO WARRANTY FOR THE PROGRAM, TO THE EXTENT PERMITTED BY APPLICABLE LAW. EXCEPT WHEN OTHERWISE STATED IN WRITING THE COPYRIGHT HOLDERS AND/OR OTHER PARTIES PROVIDE THE PROGRAM "AS IS" WITHOUT WARRANTY OF ANY KIND, EITHER EXPRESSED OR IMPLIED, INCLUDING, BUT NOT LIMITED TO, THE IMPLIED WARRANTIES OF MERCHANTABILITY AND FITNESS FOR A PARTICULAR PURPOSE. THE ENTIRE RISK AS TO THE QUALITY AND PERFORMANCE OF THE PROGRAM IS WITH YOU. SHOULD THE PROGRAM PROVE DEFECTIVE, YOU ASSUME THE COST OF ALL NECESSARY SERVICING, REPAIR OR CORRECTION.

12. IN NO EVENT UNLESS REQUIRED BY APPLICABLE LAW OR AGREED TO IN WRITING WILL ANY COPYRIGHT HOLDER, OR ANY OTHER PARTY WHO MAY MODIFY AND/OR REDISTRIBUTE THE PROGRAM AS PERMITTED ABOVE, BE LIABLE TO YOU FOR DAMAGES, INCLUDING ANY GENERAL, SPECIAL, INCIDENTAL OR CONSEQUENTIAL DAMAGES ARISING OUT OF THE USE OR INABILITY TO USE THE PROGRAM (INCLUDING BUT NOT LIMITED TO LOSS OF DATA OR DATA BEING RENDERED INACCURATE OR LOSSES SUSTAINED BY YOU OR THIRD PARTIES OR A FAILURE OF THE PROGRAM TO OPERATE WITH ANY OTHER PROGRAMS), EVEN IF SUCH HOLDER OR OTHER PARTY HAS BEEN ADVISED OF THE POSSIBILITY OF SUCH DAMAGES.

END OF TERMS AND CONDITIONS

How to Apply These Terms to Your New Programs

If you develop a new program, and you want it to be of the greatest possible use to the public,



the best way to achieve this is to make it free software which everyone can redistribute and change under these terms.

To do so, attach the following notices to the program. It is safest to attach them to the start of each source file to most effectively convey the exclusion of warranty; and each file should have at least the "copyright" line and a pointer to where the full notice is found.

one line to give the program's name and an idea of what it does. Copyright (C) yyyy name of author

This program is free software; you can redistribute it and/or modify it under the terms of the GNU General Public License as published by the Free Software Foundation; either version 2 of the License, or (at your option) any later version.

This program is distributed in the hope that it will be useful, but WITHOUT ANY WARRANTY; without even the implied warranty of MERCHANTABILITY or FITNESS FOR A PARTICULAR PURPOSE. See the GNU General Public License for more details.

You should have received a copy of the GNU General Public License along with this program; if not, write to the Free Software Foundation, Inc., 51 Franklin Street, Fifth Floor, Boston, MA 02110-1301, USA. Also add information on how to contact you by electronic and paper mail.

If the program is interactive, make it output a short notice like this when it starts in an interactive mode:

Gnomovision version 69, Copyright (C) year name of author Gnomovision comes with ABSOLUTELY NO WARRANTY; for details type `show w'. This is free software, and you are welcome to redistribute it under certain conditions; type `show c' for details.

The hypothetical commands `show w' and `show c' should show the appropriate parts of the General Public License. Of course, the commands you use may be called something other than `show w' and `show c'; they could even be mouse-clicks or menu items--whatever suits your program.

You should also get your employer (if you work as a programmer) or your school, if any, to sign a "copyright disclaimer" for the program, if necessary. Here is a sample; alter the names:

Yoyodyne, Inc., hereby disclaims all copyright interest in the program `Gnomovision' (which makes passes at compilers) written by James Hacker.

signature of Ty Coon, 1 April 1989 Ty Coon, President of Vice



socat is distributed under the terms of the GNU GPLv2;
except for install-sh, which is copyright MIT, with its own license;

In addition, as a special exception, the copyright holder gives permission to link the code of this program with any version of the OpenSSL library which is distributed under a license identical to that listed in the included COPYING.OpenSSL file, and distribute linked combinations including the two. You must obey the GNU General Public License in all respects for all of the code used other than OpenSSL. If you modify this file, you may extend this exception to your version of the file, but you are not obligated to do so. If you do not wish to do so, delete this exception statement from your version.

This program is free software; you can redistribute it and/or modify it under the terms of the GNU General Public License as published by the Free Software Foundation, version 2 of the License

This program is distributed in the hope that it will be useful, but WITHOUT ANY WARRANTY; without even the implied warranty of MERCHANTABILITY or FITNESS FOR A PARTICULAR PURPOSE. See the GNU General Public License for more details.

You should have received a copy of the GNU General Public License along with this program; if not, write to the Free Software Foundation, Inc., 675 Mass Ave, Cambridge, MA 02139, USA.

GPL-1.0

GNU GENERAL PUBLIC LICENSE

Version 1, February 1989

Copyright (C) 1989 Free Software Foundation, Inc. 51 Franklin St, Fifth Floor, Boston, MA 02110-1301 USA

Everyone is permitted to copy and distribute verbatim copies of this license document, but changing it is not allowed.

Preamble

The license agreements of most software companies try to keep users at the mercy of those companies. By contrast, our General Public License is intended to guarantee your freedom to share and change free software--to make sure the software is free for all its users. The General Public License applies to the Free Software Foundation's software and to any other program whose authors commit to using it. You can use it for your programs, too.



When we speak of free software, we are referring to freedom, not price. Specifically, the General Public License is designed to make sure that you have the freedom to give away or sell copies of free software, that you receive source code or can get it if you want it, that you can change the software or use pieces of it in new free programs; and that you know you can do these things.

To protect your rights, we need to make restrictions that forbid anyone to deny you these rights or to ask you to surrender the rights. These restrictions translate to certain responsibilities for you if you distribute copies of the software, or if you modify it.

For example, if you distribute copies of a such a program, whether gratis or for a fee, you must give the recipients all the rights that you have. You must make sure that they, too, receive or can get the source code. And you must tell them their rights.

We protect your rights with two steps: (1) copyright the software, and (2) offer you this license which gives you legal permission to copy, distribute and/or modify the software.

Also, for each author's protection and ours, we want to make certain that everyone understands that there is no warranty for this free software. If the software is modified by someone else and passed on, we want its recipients to know that what they have is not the original, so that any problems introduced by others will not reflect on the original authors' reputations.

The precise terms and conditions for copying, distribution and modification follow.

GNU GENERAL PUBLIC LICENSE TERMS AND CONDITIONS FOR COPYING, DISTRIBUTION AND MODIFICATION

0. This License Agreement applies to any program or other work which contains a notice placed by the copyright holder saying it may be distributed under the terms of this General Public License. The "Program", below, refers to any such program or work, and a "work based on the Program" means either the Program or any work containing the Program or a portion of it, either verbatim or with modifications. Each licensee is addressed as "you".

1. You may copy and distribute verbatim copies of the Program's source code as you receive it, in any medium, provided that you conspicuously and appropriately publish on each copy an appropriate copyright notice and disclaimer of warranty; keep intact all the notices that refer to this General Public License and to the absence of any warranty; and give any other recipients of the Program a copy of this General Public License along with the Program. You may charge a fee for the physical act of transferring a copy.

2. You may modify your copy or copies of the Program or any portion of it, and copy and



distribute such modifications under the terms of Paragraph 1 above, provided that you also do the following:

a) cause the modified files to carry prominent notices stating that you changed the files and the date of any change; and

b) cause the whole of any work that you distribute or publish, that in whole or in part contains the Program or any part thereof, either with or without modifications, to be licensed at no charge to all third parties under the terms of this General Public License (except that you may choose to grant warranty protection to some or all third parties, at your option).

c) If the modified program normally reads commands interactively when run, you must cause it, when started running for such interactive use in the simplest and most usual way, to print or display an announcement including an appropriate copyright notice and a notice that there is no warranty (or else, saying that you provide a warranty) and that users may redistribute the program under these conditions, and telling the user how to view a copy of this General Public License.

d) You may charge a fee for the physical act of transferring a copy, and you may at your option offer warranty protection in exchange for a fee.

Mere aggregation of another independent work with the Program (or its derivative) on a volume of a storage or distribution medium does not bring the other work under the scope of these terms.

3. You may copy and distribute the Program (or a portion or derivative of it, under Paragraph 2) in object code or executable form under the terms of Paragraphs 1 and 2 above provided that you also do one of the following:

a) accompany it with the complete corresponding machine-readable source code, which must be distributed under the terms of Paragraphs 1 and 2 above; or,

b) accompany it with a written offer, valid for at least three years, to give any third party free (except for a nominal charge for the cost of distribution) a complete machine-readable copy of the corresponding source code, to be distributed under the terms of Paragraphs 1 and 2 above; or,

c) accompany it with the information you received as to where the corresponding source code may be obtained. (This alternative is allowed only for noncommercial distribution and only if you received the program in object code or executable form alone.)

Source code for a work means the preferred form of the work for making modifications to it. For an executable file, complete source code means all the source code for all modules it



contains; but, as a special exception, it need not include source code for modules which are standard libraries that accompany the operating system on which the executable file runs, or for standard header files or definitions files that accompany that operating system.

4. You may not copy, modify, sublicense, distribute or transfer the Program except as expressly provided under this General Public License. Any attempt otherwise to copy, modify, sublicense, distribute or transfer the Program is void, and will automatically terminate your rights to use the Program under this License. However, parties who have received copies, or rights to use copies, from you under this General Public License will not have their licenses terminated so long as such parties remain in full compliance.

5. By copying, distributing or modifying the Program (or any work based on the Program) you indicate your acceptance of this license to do so, and all its terms and conditions.

6. Each time you redistribute the Program (or any work based on the Program), the recipient automatically receives a license from the original licensor to copy, distribute or modify the Program subject to these terms and conditions. You may not impose any further restrictions on the recipients' exercise of the rights granted herein.

7. The Free Software Foundation may publish revised and/or new versions of the General Public License from time to time. Such new versions will be similar in spirit to the present version, but may differ in detail to address new problems or concerns.

Each version is given a distinguishing version number. If the Program specifies a version number of the license which applies to it and "any later version", you have the option of following the terms and conditions either of that version or of any later version published by the Free Software Foundation. If the Program does not specify a version number of the license, you may choose any version ever published by the Free Software Foundation.

8. If you wish to incorporate parts of the Program into other free programs whose distribution conditions are different, write to the author to ask for permission. For software which is copyrighted by the Free Software Foundation, write to the Free Software Foundation; we sometimes make exceptions for this. Our decision will be guided by the two goals of preserving the free status of all derivatives of our free software and of promoting the sharing and reuse of software generally.

NO WARRANTY

9. BECAUSE THE PROGRAM IS LICENSED FREE OF CHARGE, THERE IS NO WARRANTY FOR THE PROGRAM, TO THE EXTENT PERMITTED BY APPLICABLE LAW. EXCEPT WHEN OTHERWISE STATED IN WRITING THE COPYRIGHT HOLDERS AND/OR OTHER PARTIES PROVIDE THE PROGRAM "AS IS" WITHOUT WARRANTY OF ANY KIND, EITHER EXPRESSED OR IMPLIED, INCLUDING, BUT NOT LIMITED TO, THE IMPLIED WARRANTIES OF



MERCHANTABILITY AND FITNESS FOR A PARTICULAR PURPOSE, THE ENTIRE RISK AS TO THE QUALITY AND PERFORMANCE OF THE PROGRAM IS WITH YOU. SHOULD THE PROGRAM PROVE DEFECTIVE, YOU ASSUME THE COST OF ALL NECESSARY SERVICING, REPAIR OR CORRECTION.

10. IN NO EVENT UNLESS REQUIRED BY APPLICABLE LAW OR AGREED TO IN WRITING WILL ANY COPYRIGHT HOLDER, OR ANY OTHER PARTY WHO MAY MODIFY AND/OR REDISTRIBUTE THE PROGRAM AS PERMITTED ABOVE, BE LIABLE TO YOU FOR DAMAGES, INCLUDING ANY GENERAL, SPECIAL, INCIDENTAL OR CONSEQUENTIAL DAMAGES ARISING OUT OF THE USE OR INABILITY TO USE THE PROGRAM (INCLUDING BUT NOT LIMITED TO LOSS OF DATA OR DATA BEING RENDERED INACCURATE OR LOSSES SUSTAINED BY YOU OR THIRD PARTIES OR A FAILURE OF THE PROGRAM TO OPERATE WITH ANY OTHER PROGRAMS), EVEN IF SUCH HOLDER OR OTHER PARTY HAS BEEN ADVISED OF THE POSSIBILITY OF SUCH DAMAGES.

END OF TERMS AND CONDITIONS

Appendix: How to Apply These Terms to Your New Programs

If you develop a new program, and you want it to be of the greatest possible use to humanity, the best way to achieve this is to make it free software which everyone can redistribute and change under these terms.

To do so, attach the following notices to the program. It is safest to attach them to the start of each source file to most effectively convey the exclusion of warranty; and each file should have at least the "copyright" line and a pointer to where the full notice is found.

<one line to give the program's name and a brief idea of what it does.> Copyright (C) 19yy
<name of author>

This program is free software; you can redistribute it and/or modify it under the terms of the GNU General Public License as published by the Free Software Foundation; either version 1, or (at your option) any later version.

This program is distributed in the hope that it will be useful, but WITHOUT ANY WARRANTY; without even the implied warranty of MERCHANTABILITY or FITNESS FOR A PARTICULAR PURPOSE. See the GNU General Public License for more details.

You should have received a copy of the GNU General Public License along with this program; if not, write to the Free Software Foundation, Inc., 675 Mass Ave, Cambridge, MA 02139, USA.

Also add information on how to contact you by electronic and paper mail.



If the program is interactive, make it output a short notice like this when it starts in an interactive mode:

```
Gnomovision version 69, Copyright (C) 19xx name of author
GNOMOVISION COMES WITH ABSOLUTELY NO WARRANTY; for details
type `show w'. This is free software, and you are welcome to
redistribute it under certain conditions; type `show c' for details.
```

The hypothetical commands ``show w'` and ``show c'` should show the appropriate parts of the General Public License. Of course, the commands you use may be called something other than ``show w'` and ``show c'`; they could even be mouse-clicks or menu items--whatever suits your program.

You should also get your employer (if you work as a programmer) or your school, if any, to sign a "copyright disclaimer" for the program, if necessary. Here a sample; alter the names:

```
Yoyodyne, Inc., hereby disclaims all copyright interest in the
program `Gnomovision' (a program to direct compilers to make passes
at assemblers) written by James Hacker.
```

```
<signature of Ty Coon>, 1 April 1989 Ty Coon, President of Vice
```

That's all there is to it!

GPL-2.0

GNU GENERAL PUBLIC LICENSE

Version 2, June 1991

Copyright (C) 1989, 1991 Free Software Foundation, Inc.
51 Franklin Street, Fifth Floor, Boston, MA 02110-1301, USA

Everyone is permitted to copy and distribute verbatim copies of this license document, but changing it is not allowed.

Preamble

The licenses for most software are designed to take away your freedom to share and change it. By contrast, the GNU General Public License is intended to guarantee your freedom to share and change free software--to make sure the software is free for all its users. This General Public License applies to most of the Free Software Foundation's software and to any other program whose authors commit to using it. (Some other Free Software Foundation software is



covered by the GNU Lesser General Public License instead.) You can apply it to your programs, too.

When we speak of free software, we are referring to freedom, not price. Our General Public Licenses are designed to make sure that you have the freedom to distribute copies of free software (and charge for this service if you wish), that you receive source code or can get it if you want it, that you can change the software or use pieces of it in new free programs; and that you know you can do these things.

To protect your rights, we need to make restrictions that forbid anyone to deny you these rights or to ask you to surrender the rights. These restrictions translate to certain responsibilities for you if you distribute copies of the software, or if you modify it.

For example, if you distribute copies of such a program, whether gratis or for a fee, you must give the recipients all the rights that you have. You must make sure that they, too, receive or can get the source code. And you must show them these terms so they know their rights.

We protect your rights with two steps: (1) copyright the software, and (2) offer you this license which gives you legal permission to copy, distribute and/or modify the software.

Also, for each author's protection and ours, we want to make certain that everyone understands that there is no warranty for this free software. If the software is modified by someone else and passed on, we want its recipients to know that what they have is not the original, so that any problems introduced by others will not reflect on the original authors' reputations.

Finally, any free program is threatened constantly by software patents. We wish to avoid the danger that redistributors of a free program will individually obtain patent licenses, in effect making the program proprietary. To prevent this, we have made it clear that any patent must be licensed for everyone's free use or not licensed at all.

The precise terms and conditions for copying, distribution and modification follow.

TERMS AND CONDITIONS FOR COPYING, DISTRIBUTION AND MODIFICATION

0. This License applies to any program or other work which contains a notice placed by the copyright holder saying it may be distributed under the terms of this General Public License. The "Program", below, refers to any such program or work, and a "work based on the Program" means either the Program or any derivative work under copyright law: that is to say, a work containing the Program or a portion of it, either verbatim or with modifications and/or translated into another language. (Hereinafter, translation is included without limitation in the term "modification".) Each licensee is addressed as "you".



Activities other than copying, distribution and modification are not covered by this License; they are outside its scope. The act of running the Program is not restricted, and the output from the Program is covered only if its contents constitute a work based on the Program (independent of having been made by running the Program). Whether that is true depends on what the Program does.

1. You may copy and distribute verbatim copies of the Program's source code as you receive it, in any medium, provided that you conspicuously and appropriately publish on each copy an appropriate copyright notice and disclaimer of warranty; keep intact all the notices that refer to this License and to the absence of any warranty; and give any other recipients of the Program a copy of this License along with the Program.

You may charge a fee for the physical act of transferring a copy, and you may at your option offer warranty protection in exchange for a fee.

2. You may modify your copy or copies of the Program or any portion of it, thus forming a work based on the Program, and copy and distribute such modifications or work under the terms of Section 1 above, provided that you also meet all of these conditions:

a) You must cause the modified files to carry prominent notices stating that you changed the files and the date of any change.

b) You must cause any work that you distribute or publish, that in whole or in part contains or is derived from the Program or any part thereof, to be licensed as a whole at no charge to all third parties under the terms of this License.

c) If the modified program normally reads commands interactively when run, you must cause it, when started running for such interactive use in the most ordinary way, to print or display an announcement including an appropriate copyright notice and a notice that there is no warranty (or else, saying that you provide a warranty) and that users may redistribute the program under these conditions, and telling the user how to view a copy of this License. (Exception: if the Program itself is interactive but does not normally print such an announcement, your work based on the Program is not required to print an announcement.)

These requirements apply to the modified work as a whole. If identifiable sections of that work are not derived from the Program, and can be reasonably considered independent and separate works in themselves, then this License, and its terms, do not apply to those sections when you distribute them as separate works. But when you distribute the same sections as part of a whole which is a work based on the Program, the distribution of the whole must be on the terms of this License, whose permissions for other licensees extend to the entire whole, and thus to each and every part regardless of who wrote it.



Thus, it is not the intent of this section to claim rights or contest your rights to work written entirely by you; rather, the intent is to exercise the right to control the distribution of derivative or collective works based on the Program.

In addition, mere aggregation of another work not based on the Program with the Program (or with a work based on the Program) on a volume of a storage or distribution medium does not bring the other work under the scope of this License.

3. You may copy and distribute the Program (or a work based on it, under Section 2) in object code or executable form under the terms of Sections 1 and 2 above provided that you also do one of the following:

a) Accompany it with the complete corresponding machine-readable source code, which must be distributed under the terms of Sections 1 and 2 above on a medium customarily used for software interchange; or,

b) Accompany it with a written offer, valid for at least three years, to give any third party, for a charge no more than your cost of physically performing source distribution, a complete machine-readable copy of the corresponding source code, to be distributed under the terms of Sections 1 and 2 above on a medium customarily used for software interchange; or,

c) Accompany it with the information you received as to the offer to distribute corresponding source code. (This alternative is allowed only for noncommercial distribution and only if you received the program in object code or executable form with such an offer, in accord with Subsection b above.)

The source code for a work means the preferred form of the work for making modifications to it. For an executable work, complete source code means all the source code for all modules it contains, plus any associated interface definition files, plus the scripts used to control compilation and installation of the executable. However, as a special exception, the source code distributed need not include anything that is normally distributed (in either source or binary form) with the major components (compiler, kernel, and so on) of the operating system on which the executable runs, unless that component itself accompanies the executable.

If distribution of executable or object code is made by offering access to copy from a designated place, then offering equivalent access to copy the source code from the same place counts as distribution of the source code, even though third parties are not compelled to copy the source along with the object code.

4. You may not copy, modify, sublicense, or distribute the Program except as expressly provided under this License. Any attempt otherwise to copy, modify, sublicense or distribute the Program is void, and will automatically terminate your rights under this License. However, parties who have received copies, or rights, from you under this License will not have their



licenses terminated so long as such parties remain in full compliance.

5. You are not required to accept this License, since you have not signed it. However, nothing else grants you permission to modify or distribute the Program or its derivative works. These actions are prohibited by law if you do not accept this License. Therefore, by modifying or distributing the Program (or any work based on the Program), you indicate your acceptance of this License to do so, and all its terms and conditions for copying, distributing or modifying the Program or works based on it.

6. Each time you redistribute the Program (or any work based on the Program), the recipient automatically receives a license from the original licensor to copy, distribute or modify the Program subject to these terms and conditions. You may not impose any further restrictions on the recipients' exercise of the rights granted herein. You are not responsible for enforcing compliance by third parties to this License.

7. If, as a consequence of a court judgment or allegation of patent infringement or for any other reason (not limited to patent issues), conditions are imposed on you (whether by court order, agreement or otherwise) that contradict the conditions of this License, they do not excuse you from the conditions of this License. If you cannot distribute so as to satisfy simultaneously your obligations under this License and any other pertinent obligations, then as a consequence you may not distribute the Program at all. For example, if a patent license would not permit royalty-free redistribution of the Program by all those who receive copies directly or indirectly through you, then the only way you could satisfy both it and this License would be to refrain entirely from distribution of the Program.

If any portion of this section is held invalid or unenforceable under any particular circumstance, the balance of the section is intended to apply and the section as a whole is intended to apply in other circumstances.

It is not the purpose of this section to induce you to infringe any patents or other property right claims or to contest validity of any such claims; this section has the sole purpose of protecting the integrity of the free software distribution system, which is implemented by public license practices. Many people have made generous contributions to the wide range of software distributed through that system in reliance on consistent application of that system; it is up to the author/donor to decide if he or she is willing to distribute software through any other system and a licensee cannot impose that choice.

This section is intended to make thoroughly clear what is believed to be a consequence of the rest of this License.

8. If the distribution and/or use of the Program is restricted in certain countries either by patents or by copyrighted interfaces, the original copyright holder who places the Program under this License may add an explicit geographical distribution limitation excluding those



countries, so that distribution is permitted only in or among countries not thus excluded. In such case, this License incorporates the limitation as if written in the body of this License.

9. The Free Software Foundation may publish revised and/or new versions of the General Public License from time to time. Such new versions will be similar in spirit to the present version, but may differ in detail to address new problems or concerns.

Each version is given a distinguishing version number. If the Program specifies a version number of this License which applies to it and "any later version", you have the option of following the terms and conditions either of that version or of any later version published by the Free Software Foundation. If the Program does not specify a version number of this License, you may choose any version ever published by the Free Software Foundation.

10. If you wish to incorporate parts of the Program into other free programs whose distribution conditions are different, write to the author to ask for permission. For software which is copyrighted by the Free Software Foundation, write to the Free Software Foundation; we sometimes make exceptions for this. Our decision will be guided by the two goals of preserving the free status of all derivatives of our free software and of promoting the sharing and reuse of software generally.

NO WARRANTY

11. BECAUSE THE PROGRAM IS LICENSED FREE OF CHARGE, THERE IS NO WARRANTY FOR THE PROGRAM, TO THE EXTENT PERMITTED BY APPLICABLE LAW. EXCEPT WHEN OTHERWISE STATED IN WRITING THE COPYRIGHT HOLDERS AND/OR OTHER PARTIES PROVIDE THE PROGRAM "AS IS" WITHOUT WARRANTY OF ANY KIND, EITHER EXPRESSED OR IMPLIED, INCLUDING, BUT NOT LIMITED TO, THE IMPLIED WARRANTIES OF MERCHANTABILITY AND FITNESS FOR A PARTICULAR PURPOSE. THE ENTIRE RISK AS TO THE QUALITY AND PERFORMANCE OF THE PROGRAM IS WITH YOU. SHOULD THE PROGRAM PROVE DEFECTIVE, YOU ASSUME THE COST OF ALL NECESSARY SERVICING, REPAIR OR CORRECTION.

12. IN NO EVENT UNLESS REQUIRED BY APPLICABLE LAW OR AGREED TO IN WRITING WILL ANY COPYRIGHT HOLDER, OR ANY OTHER PARTY WHO MAY MODIFY AND/OR REDISTRIBUTE THE PROGRAM AS PERMITTED ABOVE, BE LIABLE TO YOU FOR DAMAGES, INCLUDING ANY GENERAL, SPECIAL, INCIDENTAL OR CONSEQUENTIAL DAMAGES ARISING OUT OF THE USE OR INABILITY TO USE THE PROGRAM (INCLUDING BUT NOT LIMITED TO LOSS OF DATA OR DATA BEING RENDERED INACCURATE OR LOSSES SUSTAINED BY YOU OR THIRD PARTIES OR A FAILURE OF THE PROGRAM TO OPERATE WITH ANY OTHER PROGRAMS), EVEN IF SUCH HOLDER OR OTHER PARTY HAS BEEN ADVISED OF THE POSSIBILITY OF SUCH DAMAGES.

END OF TERMS AND CONDITIONS



How to Apply These Terms to Your New Programs

If you develop a new program, and you want it to be of the greatest possible use to the public, the best way to achieve this is to make it free software which everyone can redistribute and change under these terms.

To do so, attach the following notices to the program. It is safest to attach them to the start of each source file to most effectively convey the exclusion of warranty; and each file should have at least the "copyright" line and a pointer to where the full notice is found.

one line to give the program's name and an idea of what it does. Copyright (C) yyyy name of author

This program is free software; you can redistribute it and/or modify it under the terms of the GNU General Public License as published by the Free Software Foundation; either version 2 of the License, or (at your option) any later version.

This program is distributed in the hope that it will be useful, but WITHOUT ANY WARRANTY; without even the implied warranty of MERCHANTABILITY or FITNESS FOR A PARTICULAR PURPOSE. See the GNU General Public License for more details.

You should have received a copy of the GNU General Public License along with this program; if not, write to the Free Software Foundation, Inc., 51 Franklin Street, Fifth Floor, Boston, MA 02110-1301, USA. Also add information on how to contact you by electronic and paper mail.

If the program is interactive, make it output a short notice like this when it starts in an interactive mode:

Gnomovision version 69, Copyright (C) year name of author Gnomovision comes with ABSOLUTELY NO WARRANTY; for details type `show w'. This is free software, and you are welcome to redistribute it under certain conditions; type `show c' for details.

The hypothetical commands `show w' and `show c' should show the appropriate parts of the General Public License. Of course, the commands you use may be called something other than `show w' and `show c'; they could even be mouse-clicks or menu items--whatever suits your program.

You should also get your employer (if you work as a programmer) or your school, if any, to sign a "copyright disclaimer" for the program, if necessary. Here is a sample; alter the names:

Yoyodyne, Inc., hereby disclaims all copyright interest in the program `Gnomovision' (which



makes passes at compilers) written by James Hacker.

signature of Ty Coon, 1 April 1989 Ty Coon, President of Vice

HPND

Permission to use, copy, modify and distribute this software and its documentation for any purpose and without fee is hereby granted, provided that the above copyright notice appear in all copies[,] [and] that both [that] [the] copyright notice and this permission notice appear in supporting documentation[, and that the name [of] <copyright holder> [or <related entities>] not be used in advertising or publicity pertaining to distribution of the software without specific, written prior permission]. [<copyright holder> makes no representations about the suitability of this software for any purpose. It is provided "as is" without express or implied warranty.]

[<copyright holder> DISCLAIMS ALL WARRANTIES WITH REGARD TO THIS SOFTWARE, INCLUDING ALL IMPLIED WARRANTIES OF MERCHANTABILITY AND FITNESS[,] IN NO EVENT SHALL <copyright holder> BE LIABLE FOR ANY SPECIAL, INDIRECT OR CONSEQUENTIAL DAMAGES OR ANY DAMAGES WHATSOEVER RESULTING FROM LOSS OF USE, DATA OR PROFITS, WHETHER IN AN ACTION OF CONTRACT, NEGLIGENCE OR OTHER TORTIOUS ACTION, ARISING OUT OF OR IN CONNECTION WITH THE USE OR PERFORMANCE OF THIS SOFTWARE.]

ICU

Permission is hereby granted, free of charge, to any person obtaining a copy of this software and associated documentation files (the "Software"), to deal in the Software without restriction, including without limitation the rights to use, copy, modify, merge, publish, distribute, and/or sell copies of the Software, and to permit persons to whom the Software is furnished to do so, provided that the above copyright notice(s) and this permission notice appear in all copies of the Software and that both the above copyright notice(s) and this permission notice appear in supporting documentation.

THE SOFTWARE IS PROVIDED "AS IS", WITHOUT WARRANTY OF ANY KIND, EXPRESS OR IMPLIED, INCLUDING BUT NOT LIMITED TO THE WARRANTIES OF MERCHANTABILITY, FITNESS FOR A PARTICULAR PURPOSE AND NONINFRINGEMENT OF THIRD PARTY RIGHTS. IN NO EVENT SHALL THE COPYRIGHT HOLDER OR HOLDERS INCLUDED IN THIS NOTICE BE LIABLE FOR ANY CLAIM, OR ANY SPECIAL INDIRECT OR CONSEQUENTIAL DAMAGES, OR ANY DAMAGES WHATSOEVER RESULTING FROM LOSS OF USE, DATA OR PROFITS, WHETHER IN AN ACTION OF CONTRACT, NEGLIGENCE OR OTHER TORTIOUS ACTION, ARISING OUT OF OR IN CONNECTION WITH THE USE OR PERFORMANCE OF THIS SOFTWARE.



Except as contained in this notice, the name of a copyright holder shall not be used in advertising or otherwise to promote the sale, use or other dealings in this Software without prior written authorization of the copyright holder.

IJG

Independent JPEG Group License

LEGAL ISSUES

In plain English:

1. We don't promise that this software works. (But if you find any bugs, please let us know!)
2. You can use this software for whatever you want. You don't have to pay us.
3. You may not pretend that you wrote this software. If you use it in a program, you must acknowledge somewhere in your documentation that you've used the IJG code.

In legalese:

The authors make NO WARRANTY or representation, either express or implied, with respect to this software, its quality, accuracy, merchantability, or fitness for a particular purpose. This software is provided "AS IS", and you, its user, assume the entire risk as to its quality and accuracy.

This software is copyright (C) 1991-1998, Thomas G. Lane. All Rights Reserved except as specified below.

Permission is hereby granted to use, copy, modify, and distribute this software (or portions thereof) for any purpose, without fee, subject to these conditions:

- (1) If any part of the source code for this software is distributed, then this README file must be included, with this copyright and no-warranty notice unaltered; and any additions, deletions, or changes to the original files must be clearly indicated in accompanying documentation.
- (2) If only executable code is distributed, then the accompanying documentation must state that "this software is based in part on the work of the Independent JPEG Group".
- (3) Permission for use of this software is granted only if the user accepts full responsibility for any undesirable consequences; the authors accept NO LIABILITY for damages of any kind.

These conditions apply to any software derived from or based on the IJG code, not just to the unmodified library. If you use our work, you ought to acknowledge us.



Permission is NOT granted for the use of any IJG author's name or company name in advertising or publicity relating to this software or products derived from it. This software may be referred to only as "the Independent JPEG Group's software".

We specifically permit and encourage the use of this software as the basis of commercial products, provided that all warranty or liability claims are assumed by the product vendor.

ansi2knr.c is included in this distribution by permission of L. Peter Deutsch, sole proprietor of its copyright holder, Aladdin Enterprises of Menlo Park, CA. ansi2knr.c is NOT covered by the above copyright and conditions, but instead by the usual distribution terms of the Free Software Foundation; principally, that you must include source code if you redistribute it. (See the file ansi2knr.c for full details.) However, since ansi2knr.c is not needed as part of any program generated from the IJG code, this does not limit you more than the foregoing paragraphs do.

The Unix configuration script "configure" was produced with GNU Autoconf. It is copyright by the Free Software Foundation but is freely distributable. The same holds for its supporting scripts (config.guess, config.sub, ltconfig, ltmain.sh). Another support script, install-sh, is copyright by M.I.T. but is also freely distributable.

It appears that the arithmetic coding option of the JPEG spec is covered by patents owned by IBM, AT&T, and Mitsubishi. Hence arithmetic coding cannot legally be used without obtaining one or more licenses. For this reason, support for arithmetic coding has been removed from the free JPEG software. (Since arithmetic coding provides only a marginal gain over the unpatented Huffman mode, it is unlikely that very many implementations will support it.) So far as we are aware, there are no patent restrictions on the remaining code.

The IJG distribution formerly included code to read and write GIF files. To avoid entanglement with the Unisys LZW patent, GIF reading support has been removed altogether, and the GIF writer has been simplified to produce "uncompressed GIFs". This technique does not use the LZW algorithm; the resulting GIF files are larger than usual, but are readable by all standard GIF decoders.

We are required to state that

"The Graphics Interchange Format(c) is the Copyright property of CompuServe Incorporated. GIF(sm) is a Service Mark property of CompuServe Incorporated."

ISC

Permission to use, copy, modify, and/or distribute this software for any purpose with or without fee is hereby granted, provided that the above copyright notice and this permission



notice appear in all copies.

THE SOFTWARE IS PROVIDED "AS IS" AND THE AUTHOR DISCLAIMS ALL WARRANTIES WITH REGARD TO THIS SOFTWARE INCLUDING ALL IMPLIED WARRANTIES OF MERCHANTABILITY AND FITNESS. IN NO EVENT SHALL THE AUTHOR BE LIABLE FOR ANY SPECIAL, DIRECT, INDIRECT, OR CONSEQUENTIAL DAMAGES OR ANY DAMAGES WHATSOEVER RESULTING FROM LOSS OF USE, DATA OR PROFITS, WHETHER IN AN ACTION OF CONTRACT, NEGLIGENCE OR OTHER TORTIOUS ACTION, ARISING OUT OF OR IN CONNECTION WITH THE USE OR PERFORMANCE OF THIS SOFTWARE.

Info-ZIP

Info-ZIP License

Copyright (c) 1990-2009 Info-ZIP. All rights reserved.

For the purposes of this copyright and license, "Info-ZIP" is defined as the following set of individuals:

Mark Adler, John Bush, Karl Davis, Harald Denker, Jean-Michel Dubois, Jean-loup Gailly, Hunter Goatley, Ed Gordon, Ian Gorman, Chris Herborth, Dirk Haase, Greg Hartwig, Robert Heath, Jonathan Hudson, Paul Kienitz, David Kirschbaum, Johnny Lee, Onno van der Linden, Igor Mandrichenko, Steve P. Miller, Sergio Monesi, Keith Owens, George Petrov, Greg Roelofs, Kai Uwe Rommel, Steve Salisbury, Dave Smith, Steven M. Schweda, Christian Spieler, Cosmin Truta, Antoine Verheijen, Paul von Behren, Rich Wales, Mike White.

This software is provided "as is," without warranty of any kind, express or implied. In no event shall Info-ZIP or its contributors be held liable for any direct, indirect, incidental, special or consequential damages arising out of the use of or inability to use this software.

Permission is granted to anyone to use this software for any purpose, including commercial applications, and to alter it and redistribute it freely, subject to the above disclaimer and the following restrictions:

- * Redistributions of source code (in whole or in part) must retain the above copyright notice, definition, disclaimer, and this list of conditions.
- * Redistributions in binary form (compiled executables and libraries) must reproduce the above copyright notice, definition, disclaimer, and this list of conditions in documentation and/or other materials provided with the distribution. Additional documentation is not needed for executables where a command line license option provides these and a note regarding this option is in the executable's startup banner. The sole exception to this condition is redistribution of a standard UnZipSFX binary (including SFXWiz) as part of a self-extracting



archive; that is permitted without inclusion of this license, as long as the normal SFX banner has not been removed from the binary or disabled.

* Altered versions--including, but not limited to, ports to new operating systems, existing ports with new graphical interfaces, versions with modified or added functionality, and dynamic, shared, or static library versions not from Info-ZIP--must be plainly marked as such and must not be misrepresented as being the original source or, if binaries, compiled from the original source. Such altered versions also must not be misrepresented as being Info-ZIP releases--including, but not limited to, labeling of the altered versions with the names "Info-ZIP" (or any variation thereof, including, but not limited to, different capitalizations), "Pocket UnZip," "WiZ" or "MacZip" without the explicit permission of Info-ZIP. Such altered versions are further prohibited from misrepresentative use of the Zip-Bugs or Info-ZIP e-mail addresses or the Info-ZIP URL(s), such as to imply Info-ZIP will provide support for the altered versions.

* Info-ZIP retains the right to use the names "Info-ZIP," "Zip," "UnZip," "UnZipSFX," "WiZ," "Pocket UnZip," "Pocket Zip," and "MacZip" for its own source and binary releases.

LGPL-2.1

GNU LESSER GENERAL PUBLIC LICENSE

Version 2.1, February 1999

Copyright (C) 1991, 1999 Free Software Foundation, Inc.
51 Franklin Street, Fifth Floor, Boston, MA 02110-1301 USA

Everyone is permitted to copy and distribute verbatim copies of this license document, but changing it is not allowed.

[This is the first released version of the Lesser GPL. It also counts as the successor of the GNU Library Public License, version 2, hence the version number 2.1.]

Preamble

The licenses for most software are designed to take away your freedom to share and change it. By contrast, the GNU General Public Licenses are intended to guarantee your freedom to share and change free software--to make sure the software is free for all its users.

This license, the Lesser General Public License, applies to some specially designated software packages--typically libraries--of the Free Software Foundation and other authors who decide to use it. You can use it too, but we suggest you first think carefully about whether this license or the ordinary General Public License is the better strategy to use in any particular case, based on the explanations below.



When we speak of free software, we are referring to freedom of use, not price. Our General Public Licenses are designed to make sure that you have the freedom to distribute copies of free software (and charge for this service if you wish); that you receive source code or can get it if you want it; that you can change the software and use pieces of it in new free programs; and that you are informed that you can do these things.

To protect your rights, we need to make restrictions that forbid distributors to deny you these rights or to ask you to surrender these rights. These restrictions translate to certain responsibilities for you if you distribute copies of the library or if you modify it.

For example, if you distribute copies of the library, whether gratis or for a fee, you must give the recipients all the rights that we gave you. You must make sure that they, too, receive or can get the source code. If you link other code with the library, you must provide complete object files to the recipients, so that they can relink them with the library after making changes to the library and recompiling it. And you must show them these terms so they know their rights.

We protect your rights with a two-step method: (1) we copyright the library, and (2) we offer you this license, which gives you legal permission to copy, distribute and/or modify the library.

To protect each distributor, we want to make it very clear that there is no warranty for the free library. Also, if the library is modified by someone else and passed on, the recipients should know that what they have is not the original version, so that the original author's reputation will not be affected by problems that might be introduced by others.

Finally, software patents pose a constant threat to the existence of any free program. We wish to make sure that a company cannot effectively restrict the users of a free program by obtaining a restrictive license from a patent holder. Therefore, we insist that any patent license obtained for a version of the library must be consistent with the full freedom of use specified in this license.

Most GNU software, including some libraries, is covered by the ordinary GNU General Public License. This license, the GNU Lesser General Public License, applies to certain designated libraries, and is quite different from the ordinary General Public License. We use this license for certain libraries in order to permit linking those libraries into non-free programs.

When a program is linked with a library, whether statically or using a shared library, the combination of the two is legally speaking a combined work, a derivative of the original library. The ordinary General Public License therefore permits such linking only if the entire combination fits its criteria of freedom. The Lesser General Public License permits more lax criteria for linking other code with the library.



We call this license the "Lesser" General Public License because it does Less to protect the user's freedom than the ordinary General Public License. It also provides other free software developers Less of an advantage over competing non-free programs. These disadvantages are the reason we use the ordinary General Public License for many libraries. However, the Lesser license provides advantages in certain special circumstances.

For example, on rare occasions, there may be a special need to encourage the widest possible use of a certain library, so that it becomes a de-facto standard. To achieve this, non-free programs must be allowed to use the library. A more frequent case is that a free library does the same job as widely used non-free libraries. In this case, there is little to gain by limiting the free library to free software only, so we use the Lesser General Public License.

In other cases, permission to use a particular library in non-free programs enables a greater number of people to use a large body of free software. For example, permission to use the GNU C Library in non-free programs enables many more people to use the whole GNU operating system, as well as its variant, the GNU/Linux operating system.

Although the Lesser General Public License is Less protective of the users' freedom, it does ensure that the user of a program that is linked with the Library has the freedom and the wherewithal to run that program using a modified version of the Library.

The precise terms and conditions for copying, distribution and modification follow. Pay close attention to the difference between a "work based on the library" and a "work that uses the library". The former contains code derived from the library, whereas the latter must be combined with the library in order to run.

TERMS AND CONDITIONS FOR COPYING, DISTRIBUTION AND MODIFICATION

0. This License Agreement applies to any software library or other program which contains a notice placed by the copyright holder or other authorized party saying it may be distributed under the terms of this Lesser General Public License (also called "this License"). Each licensee is addressed as "you".

A "library" means a collection of software functions and/or data prepared so as to be conveniently linked with application programs (which use some of those functions and data) to form executables.

The "Library", below, refers to any such software library or work which has been distributed under these terms. A "work based on the Library" means either the Library or any derivative work under copyright law: that is to say, a work containing the Library or a portion of it, either verbatim or with modifications and/or translated straightforwardly into another language. (Hereinafter, translation is included without limitation in the term "modification".)



"Source code" for a work means the preferred form of the work for making modifications to it. For a library, complete source code means all the source code for all modules it contains, plus any associated interface definition files, plus the scripts used to control compilation and installation of the library.

Activities other than copying, distribution and modification are not covered by this License; they are outside its scope. The act of running a program using the Library is not restricted, and output from such a program is covered only if its contents constitute a work based on the Library (independent of the use of the Library in a tool for writing it). Whether that is true depends on what the Library does and what the program that uses the Library does.

1. You may copy and distribute verbatim copies of the Library's complete source code as you receive it, in any medium, provided that you conspicuously and appropriately publish on each copy an appropriate copyright notice and disclaimer of warranty; keep intact all the notices that refer to this License and to the absence of any warranty; and distribute a copy of this License along with the Library.

You may charge a fee for the physical act of transferring a copy, and you may at your option offer warranty protection in exchange for a fee.

2. You may modify your copy or copies of the Library or any portion of it, thus forming a work based on the Library, and copy and distribute such modifications or work under the terms of Section 1 above, provided that you also meet all of these conditions:

- a) The modified work must itself be a software library.
- b) You must cause the files modified to carry prominent notices stating that you changed the files and the date of any change.
- c) You must cause the whole of the work to be licensed at no charge to all third parties under the terms of this License.
- d) If a facility in the modified Library refers to a function or a table of data to be supplied by an application program that uses the facility, other than as an argument passed when the facility is invoked, then you must make a good faith effort to ensure that, in the event an application does not supply such function or table, the facility still operates, and performs whatever part of its purpose remains meaningful.

(For example, a function in a library to compute square roots has a purpose that is entirely well-defined independent of the application. Therefore, Subsection 2d requires that any application-supplied function or table used by this function must be optional: if the application does not supply it, the square root function must still compute square roots.)



These requirements apply to the modified work as a whole. If identifiable sections of that work are not derived from the Library, and can be reasonably considered independent and separate works in themselves, then this License, and its terms, do not apply to those sections when you distribute them as separate works. But when you distribute the same sections as part of a whole which is a work based on the Library, the distribution of the whole must be on the terms of this License, whose permissions for other licensees extend to the entire whole, and thus to each and every part regardless of who wrote it.

Thus, it is not the intent of this section to claim rights or contest your rights to work written entirely by you; rather, the intent is to exercise the right to control the distribution of derivative or collective works based on the Library.

In addition, mere aggregation of another work not based on the Library with the Library (or with a work based on the Library) on a volume of a storage or distribution medium does not bring the other work under the scope of this License.

3. You may opt to apply the terms of the ordinary GNU General Public License instead of this License to a given copy of the Library. To do this, you must alter all the notices that refer to this License, so that they refer to the ordinary GNU General Public License, version 2, instead of to this License. (If a newer version than version 2 of the ordinary GNU General Public License has appeared, then you can specify that version instead if you wish.) Do not make any other change in these notices.

Once this change is made in a given copy, it is irreversible for that copy, so the ordinary GNU General Public License applies to all subsequent copies and derivative works made from that copy.

This option is useful when you wish to copy part of the code of the Library into a program that is not a library.

4. You may copy and distribute the Library (or a portion or derivative of it, under Section 2) in object code or executable form under the terms of Sections 1 and 2 above provided that you accompany it with the complete corresponding machine-readable source code, which must be distributed under the terms of Sections 1 and 2 above on a medium customarily used for software interchange.

If distribution of object code is made by offering access to copy from a designated place, then offering equivalent access to copy the source code from the same place satisfies the requirement to distribute the source code, even though third parties are not compelled to copy the source along with the object code.

5. A program that contains no derivative of any portion of the Library, but is designed to work



with the Library by being compiled or linked with it, is called a "work that uses the Library". Such a work, in isolation, is not a derivative work of the Library, and therefore falls outside the scope of this License.

However, linking a "work that uses the Library" with the Library creates an executable that is a derivative of the Library (because it contains portions of the Library), rather than a "work that uses the library". The executable is therefore covered by this License. Section 6 states terms for distribution of such executables.

When a "work that uses the Library" uses material from a header file that is part of the Library, the object code for the work may be a derivative work of the Library even though the source code is not. Whether this is true is especially significant if the work can be linked without the Library, or if the work is itself a library. The threshold for this to be true is not precisely defined by law.

If such an object file uses only numerical parameters, data structure layouts and accessors, and small macros and small inline functions (ten lines or less in length), then the use of the object file is unrestricted, regardless of whether it is legally a derivative work. (Executables containing this object code plus portions of the Library will still fall under Section 6.)

Otherwise, if the work is a derivative of the Library, you may distribute the object code for the work under the terms of Section 6. Any executables containing that work also fall under Section 6, whether or not they are linked directly with the Library itself.

6. As an exception to the Sections above, you may also combine or link a "work that uses the Library" with the Library to produce a work containing portions of the Library, and distribute that work under terms of your choice, provided that the terms permit modification of the work for the customer's own use and reverse engineering for debugging such modifications.

You must give prominent notice with each copy of the work that the Library is used in it and that the Library and its use are covered by this License. You must supply a copy of this License. If the work during execution displays copyright notices, you must include the copyright notice for the Library among them, as well as a reference directing the user to the copy of this License. Also, you must do one of these things:

a) Accompany the work with the complete corresponding machine-readable source code for the Library including whatever changes were used in the work (which must be distributed under Sections 1 and 2 above); and, if the work is an executable linked with the Library, with the complete machine-readable "work that uses the Library", as object code and/or source code, so that the user can modify the Library and then relink to produce a modified executable containing the modified Library. (It is understood that the user who changes the contents of definitions files in the Library will not necessarily be able to recompile the application to use the modified definitions.)



b) Use a suitable shared library mechanism for linking with the Library. A suitable mechanism is one that (1) uses at run time a copy of the library already present on the user's computer system, rather than copying library functions into the executable, and (2) will operate properly with a modified version of the library, if the user installs one, as long as the modified version is interface-compatible with the version that the work was made with.

c) Accompany the work with a written offer, valid for at least three years, to give the same user the materials specified in Subsection 6a, above, for a charge no more than the cost of performing this distribution.

d) If distribution of the work is made by offering access to copy from a designated place, offer equivalent access to copy the above specified materials from the same place.

e) Verify that the user has already received a copy of these materials or that you have already sent this user a copy.

For an executable, the required form of the "work that uses the Library" must include any data and utility programs needed for reproducing the executable from it. However, as a special exception, the materials to be distributed need not include anything that is normally distributed (in either source or binary form) with the major components (compiler, kernel, and so on) of the operating system on which the executable runs, unless that component itself accompanies the executable.

It may happen that this requirement contradicts the license restrictions of other proprietary libraries that do not normally accompany the operating system. Such a contradiction means you cannot use both them and the Library together in an executable that you distribute.

7. You may place library facilities that are a work based on the Library side-by-side in a single library together with other library facilities not covered by this License, and distribute such a combined library, provided that the separate distribution of the work based on the Library and of the other library facilities is otherwise permitted, and provided that you do these two things:

a) Accompany the combined library with a copy of the same work based on the Library, uncombined with any other library facilities. This must be distributed under the terms of the Sections above.

b) Give prominent notice with the combined library of the fact that part of it is a work based on the Library, and explaining where to find the accompanying uncombined form of the same work.

8. You may not copy, modify, sublicense, link with, or distribute the Library except as expressly



provided under this License. Any attempt otherwise to copy, modify, sublicense, link with, or distribute the Library is void, and will automatically terminate your rights under this License. However, parties who have received copies, or rights, from you under this License will not have their licenses terminated so long as such parties remain in full compliance.

9. You are not required to accept this License, since you have not signed it. However, nothing else grants you permission to modify or distribute the Library or its derivative works. These actions are prohibited by law if you do not accept this License. Therefore, by modifying or distributing the Library (or any work based on the Library), you indicate your acceptance of this License to do so, and all its terms and conditions for copying, distributing or modifying the Library or works based on it.

10. Each time you redistribute the Library (or any work based on the Library), the recipient automatically receives a license from the original licensor to copy, distribute, link with or modify the Library subject to these terms and conditions. You may not impose any further restrictions on the recipients' exercise of the rights granted herein. You are not responsible for enforcing compliance by third parties with this License.

11. If, as a consequence of a court judgment or allegation of patent infringement or for any other reason (not limited to patent issues), conditions are imposed on you (whether by court order, agreement or otherwise) that contradict the conditions of this License, they do not excuse you from the conditions of this License. If you cannot distribute so as to satisfy simultaneously your obligations under this License and any other pertinent obligations, then as a consequence you may not distribute the Library at all. For example, if a patent license would not permit royalty-free redistribution of the Library by all those who receive copies directly or indirectly through you, then the only way you could satisfy both it and this License would be to refrain entirely from distribution of the Library.

If any portion of this section is held invalid or unenforceable under any particular circumstance, the balance of the section is intended to apply, and the section as a whole is intended to apply in other circumstances.

It is not the purpose of this section to induce you to infringe any patents or other property right claims or to contest validity of any such claims; this section has the sole purpose of protecting the integrity of the free software distribution system which is implemented by public license practices. Many people have made generous contributions to the wide range of software distributed through that system in reliance on consistent application of that system; it is up to the author/donor to decide if he or she is willing to distribute software through any other system and a licensee cannot impose that choice.

This section is intended to make thoroughly clear what is believed to be a consequence of the rest of this License.

12. If the distribution and/or use of the Library is restricted in certain countries either by patents or by copyrighted interfaces, the original copyright holder who places the Library



under this License may add an explicit geographical distribution limitation excluding those countries, so that distribution is permitted only in or among countries not thus excluded. In such case, this License incorporates the limitation as if written in the body of this License.

13. The Free Software Foundation may publish revised and/or new versions of the Lesser General Public License from time to time. Such new versions will be similar in spirit to the present version, but may differ in detail to address new problems or concerns.

Each version is given a distinguishing version number. If the Library specifies a version number of this License which applies to it and "any later version", you have the option of following the terms and conditions either of that version or of any later version published by the Free Software Foundation. If the Library does not specify a license version number, you may choose any version ever published by the Free Software Foundation.

14. If you wish to incorporate parts of the Library into other free programs whose distribution conditions are incompatible with these, write to the author to ask for permission. For software which is copyrighted by the Free Software Foundation, write to the Free Software Foundation; we sometimes make exceptions for this. Our decision will be guided by the two goals of preserving the free status of all derivatives of our free software and of promoting the sharing and reuse of software generally.

NO WARRANTY

15. BECAUSE THE LIBRARY IS LICENSED FREE OF CHARGE, THERE IS NO WARRANTY FOR THE LIBRARY, TO THE EXTENT PERMITTED BY APPLICABLE LAW. EXCEPT WHEN OTHERWISE STATED IN WRITING THE COPYRIGHT HOLDERS AND/OR OTHER PARTIES PROVIDE THE LIBRARY "AS IS" WITHOUT WARRANTY OF ANY KIND, EITHER EXPRESSED OR IMPLIED, INCLUDING, BUT NOT LIMITED TO, THE IMPLIED WARRANTIES OF MERCHANTABILITY AND FITNESS FOR A PARTICULAR PURPOSE. THE ENTIRE RISK AS TO THE QUALITY AND PERFORMANCE OF THE LIBRARY IS WITH YOU. SHOULD THE LIBRARY PROVE DEFECTIVE, YOU ASSUME THE COST OF ALL NECESSARY SERVICING, REPAIR OR CORRECTION.

16. IN NO EVENT UNLESS REQUIRED BY APPLICABLE LAW OR AGREED TO IN WRITING WILL ANY COPYRIGHT HOLDER, OR ANY OTHER PARTY WHO MAY MODIFY AND/OR REDISTRIBUTE THE LIBRARY AS PERMITTED ABOVE, BE LIABLE TO YOU FOR DAMAGES, INCLUDING ANY GENERAL, SPECIAL, INCIDENTAL OR CONSEQUENTIAL DAMAGES ARISING OUT OF THE USE OR INABILITY TO USE THE LIBRARY (INCLUDING BUT NOT LIMITED TO LOSS OF DATA OR DATA BEING RENDERED INACCURATE OR LOSSES SUSTAINED BY YOU OR THIRD PARTIES OR A FAILURE OF THE LIBRARY TO OPERATE WITH ANY OTHER SOFTWARE), EVEN IF SUCH HOLDER OR OTHER PARTY HAS BEEN ADVISED OF THE POSSIBILITY OF SUCH DAMAGES.

END OF TERMS AND CONDITIONS



How to Apply These Terms to Your New Libraries

If you develop a new library, and you want it to be of the greatest possible use to the public, we recommend making it free software that everyone can redistribute and change. You can do so by permitting redistribution under these terms (or, alternatively, under the terms of the ordinary General Public License).

To apply these terms, attach the following notices to the library. It is safest to attach them to the start of each source file to most effectively convey the exclusion of warranty; and each file should have at least the "copyright" line and a pointer to where the full notice is found.

one line to give the library's name and an idea of what it does.

Copyright (C) year name of author

This library is free software; you can redistribute it and/or modify it under the terms of the GNU Lesser General Public License as published by the Free Software Foundation; either version 2.1 of the License, or (at your option) any later version.

This library is distributed in the hope that it will be useful, but WITHOUT ANY WARRANTY; without even the implied warranty of MERCHANTABILITY or FITNESS FOR A PARTICULAR PURPOSE. See the GNU Lesser General Public License for more details.

You should have received a copy of the GNU Lesser General Public License along with this library; if not, write to the Free Software Foundation, Inc., 51 Franklin Street, Fifth Floor, Boston, MA 02110-1301 USA Also add information on how to contact you by electronic and paper mail.

You should also get your employer (if you work as a programmer) or your school, if any, to sign a "copyright disclaimer" for the library, if necessary. Here is a sample; alter the names:

Yoyodyne, Inc., hereby disclaims all copyright interest in
the library `Frob' (a library for tweaking knobs) written
by James Random Hacker.

signature of Ty Coon, 1 April 1990

Ty Coon, President of Vice

That's all there is to it!

Less



Copyright (C) 1984-2005 Mark Nudelman

Redistribution and use in source and binary forms, with or without modification, are permitted provided that the following conditions are met:

1. Redistributions of source code must retain the above copyright notice, this list of conditions and the following disclaimer.
2. Redistributions in binary form must reproduce the above copyright notice in the documentation and/or other materials provided with the distribution.

THIS SOFTWARE IS PROVIDED BY THE AUTHOR "AS IS" AND ANY EXPRESS OR IMPLIED WARRANTIES, INCLUDING, BUT NOT LIMITED TO, THE IMPLIED WARRANTIES OF MERCHANTABILITY AND FITNESS FOR A PARTICULAR PURPOSE ARE DISCLAIMED. IN NO EVENT SHALL THE AUTHOR BE LIABLE FOR ANY DIRECT, INDIRECT, INCIDENTAL, SPECIAL, EXEMPLARY, OR CONSEQUENTIAL DAMAGES (INCLUDING, BUT NOT LIMITED TO, PROCUREMENT OF SUBSTITUTE GOODS OR SERVICES; LOSS OF USE, DATA, OR PROFITS; OR BUSINESS INTERRUPTION) HOWEVER CAUSED AND ON ANY THEORY OF LIABILITY, WHETHER IN CONTRACT, STRICT LIABILITY, OR TORT (INCLUDING NEGLIGENCE OR OTHERWISE) ARISING IN ANY WAY OUT OF THE USE OF THIS SOFTWARE, EVEN IF ADVISED OF THE POSSIBILITY OF SUCH DAMAGE.

Libpng

This copy of the libpng notices is provided for your convenience. In case of any discrepancy between this copy and the notices in the file png.h that is included in the libpng distribution, the latter shall prevail.

COPYRIGHT NOTICE, DISCLAIMER, and LICENSE:

If you modify libpng you may insert additional notices immediately following this sentence.

This code is released under the libpng license.

libpng versions 1.2.6, August 15, 2004, through 1.4.5, December 9, 2010, are Copyright (c) 2004, 2006-2010 Glenn Randers-Pehrson, and are distributed according to the same disclaimer and license as libpng-1.2.5 with the following individual added to the list of Contributing Authors

Cosmin Truta

libpng versions 1.0.7, July 1, 2000, through 1.2.5 - October 3, 2002, are Copyright (c) 2000-2002 Glenn Randers-Pehrson, and are distributed according to the same



disclaimer and license as libpng-1.0.6 with the following individuals added to the list of Contributing Authors

Simon-Pierre Cadieux
Eric S. Raymond
Gilles Vollant

and with the following additions to the disclaimer:

There is no warranty against interference with your enjoyment of the library or against infringement. There is no warranty that our efforts or the library will fulfill any of your particular purposes or needs. This library is provided with all faults, and the entire risk of satisfactory quality, performance, accuracy, and effort is with the user.

libpng versions 0.97, January 1998, through 1.0.6, March 20, 2000, are Copyright (c) 1998, 1999 Glenn Randers-Pehrson, and are distributed according to the same disclaimer and license as libpng-0.96, with the following individuals added to the list of Contributing Authors:

Tom Lane
Glenn Randers-Pehrson
Willem van Schaik

libpng versions 0.89, June 1996, through 0.96, May 1997, are Copyright (c) 1996, 1997 Andreas Digger
Distributed according to the same disclaimer and license as libpng-0.88, with the following individuals added to the list of Contributing Authors:

John Bowler
Kevin Bracey
Sam Bushell
Magnus Holmgren
Greg Roelofs
Tom Tanner

libpng versions 0.5, May 1995, through 0.88, January 1996, are Copyright (c) 1995, 1996 Guy Eric Schalnat, Group 42, Inc.

For the purposes of this copyright and license, "Contributing Authors" is defined as the



following set of individuals:

Andreas Dilger
Dave Martindale
Guy Eric Schalnat
Paul Schmidt
Tim Wegner

The PNG Reference Library is supplied "AS IS". The Contributing Authors and Group 42, Inc. disclaim all warranties, expressed or implied, including, without limitation, the warranties of merchantability and of fitness for any purpose. The Contributing Authors and Group 42, Inc. assume no liability for direct, indirect, incidental, special, exemplary, or consequential damages, which may result from the use of the PNG Reference Library, even if advised of the possibility of such damage.

Permission is hereby granted to use, copy, modify, and distribute this source code, or portions hereof, for any purpose, without fee, subject to the following restrictions:

1. The origin of this source code must not be misrepresented.
2. Altered versions must be plainly marked as such and must not be misrepresented as being the original source.
3. This Copyright notice may not be removed or altered from any source or altered source distribution.

The Contributing Authors and Group 42, Inc. specifically permit, without fee, and encourage the use of this source code as a component to supporting the PNG file format in commercial products. If you use this source code in a product, acknowledgment is not required but would be appreciated.

A "png_get_copyright" function is available, for convenient use in "about" boxes and the like:
`printf("%s",png_get_copyright(NULL));`

Also, the PNG logo (in PNG format, of course) is supplied in the files "pngbar.png" and "pngbar.jpg (88x31) and "pngnow.png" (98x31).

Libpng is OSI Certified Open Source Software. OSI Certified Open Source is a certification mark of the Open Source Initiative.



Glenn Randers-Pehrson
glennrp at users.sourceforge.net
December 9, 2010

MIT

Permission is hereby granted, free of charge, to any person obtaining a copy of this software and associated documentation files (the "Software"), to deal in the Software without restriction, including without limitation the rights to use, copy, modify, merge, publish, distribute, sublicense, and/or sell copies of the Software, and to permit persons to whom the Software is furnished to do so, subject to the following conditions:

The above copyright notice and this permission notice shall be included in all copies or substantial portions of the Software.

THE SOFTWARE IS PROVIDED "AS IS", WITHOUT WARRANTY OF ANY KIND, EXPRESS OR IMPLIED, INCLUDING BUT NOT LIMITED TO THE WARRANTIES OF MERCHANTABILITY, FITNESS FOR A PARTICULAR PURPOSE AND NONINFRINGEMENT. IN NO EVENT SHALL THE AUTHORS OR COPYRIGHT HOLDERS BE LIABLE FOR ANY CLAIM, DAMAGES OR OTHER LIABILITY, WHETHER IN AN ACTION OF CONTRACT, TORT OR OTHERWISE, ARISING FROM, OUT OF OR IN CONNECTION WITH THE SOFTWARE OR THE USE OR OTHER DEALINGS IN THE SOFTWARE.

MIT-like License (HarfBuzz)

HarfBuzz is licensed under the so-called "Old MIT" license. Details follow.

For parts of HarfBuzz that are licensed under different licenses see individual files names COPYING in subdirectories where applicable.

Copyright (c) 2010,2011,2012 Google, Inc.

Copyright (c) 2012 Mozilla Foundation

Copyright (c) 2011 Codethink Limited

Copyright (c) 2008,2010 Nokia Corporation and/or its subsidiary(-ies)

Copyright (c) 2009 Keith Stribley

Copyright (c) 2009 Martin Hosken and SIL International

Copyright (c) 2007 Chris Wilson

Copyright (c) 2006 Behdad Esfahbod

Copyright (c) 2005 David Turner



Copyright (c) 2004,2007,2008,2009,2010 Red Hat, Inc.
Copyright (c) 1998-2004 David Turner and Werner Lemberg

For full copyright notices consult the individual files in the package.

Permission is hereby granted, without written agreement and without license or royalty fees, to use, copy, modify, and distribute this software and its documentation for any purpose, provided that the above copyright notice and the following two paragraphs appear in all copies of this software.

IN NO EVENT SHALL THE COPYRIGHT HOLDER BE LIABLE TO ANY PARTY FOR DIRECT, INDIRECT, SPECIAL, INCIDENTAL, OR CONSEQUENTIAL DAMAGES ARISING OUT OF THE USE OF THIS SOFTWARE AND ITS DOCUMENTATION, EVEN IF THE COPYRIGHT HOLDER HAS BEEN ADVISED OF THE POSSIBILITY OF SUCH DAMAGE.

THE COPYRIGHT HOLDER SPECIFICALLY DISCLAIMS ANY WARRANTIES, INCLUDING, BUT NOT LIMITED TO, THE IMPLIED WARRANTIES OF MERCHANTABILITY AND FITNESS FOR A PARTICULAR PURPOSE. THE SOFTWARE PROVIDED HEREUNDER IS ON AN "AS IS" BASIS, AND THE COPYRIGHT HOLDER HAS NO OBLIGATION TO PROVIDE MAINTENANCE, SUPPORT, UPDATES, ENHANCEMENTS, OR MODIFICATIONS.

MIT-like License (Kazlib)

Redistribution and use in source and binary forms, with or without modification, are permitted provided that the following conditions are met:

1. Redistributions of source code must retain the above copyright notice, this list of conditions and the following disclaimer.
2. Redistributions in binary form must reproduce the above copyright notice, this list of conditions and the following disclaimer in the documentation and/or other materials provided with the distribution.
3. The name of the author may not be used to endorse or promote products derived from this software without specific prior written permission.

THIS SOFTWARE IS PROVIDED `AS IS' AND WITHOUT ANY EXPRESS OR IMPLIED WARRANTIES, INCLUDING, WITHOUT LIMITATION, THE IMPLIED



WARRANTIES OF MERCHANTABILITY AND FITNESS FOR A PARTICULAR PURPOSE.

MIT-like License (OSSP-uid)

Permission to use, copy, modify, and distribute this software for any purpose with or without fee is hereby granted, provided that the above copyright notice and this permission notice appear in all copies.

THIS SOFTWARE IS PROVIDED 'AS IS' AND ANY EXPRESSED OR IMPLIED WARRANTIES, INCLUDING, BUT NOT LIMITED TO, THE IMPLIED WARRANTIES OF MERCHANTABILITY AND FITNESS FOR A PARTICULAR PURPOSE ARE DISCLAIMED. IN NO EVENT SHALL THE AUTHORS AND COPYRIGHT HOLDERS AND THEIR CONTRIBUTORS BE LIABLE FOR ANY DIRECT, INDIRECT, INCIDENTAL, SPECIAL, EXEMPLARY, OR CONSEQUENTIAL DAMAGES (INCLUDING, BUT NOT LIMITED TO, PROCUREMENT OF SUBSTITUTE GOODS OR SERVICES; LOSS OF USE, DATA, OR PROFITS; OR BUSINESS INTERRUPTION) HOWEVER CAUSED AND ON ANY THEORY OF LIABILITY, WHETHER IN CONTRACT, STRICT LIABILITY, OR TORT (INCLUDING NEGLIGENCE OR OTHERWISE) ARISING IN ANY WAY OUT OF THE USE OF THIS SOFTWARE, EVEN IF ADVISED OF THE POSSIBILITY OF SUCH DAMAGE.

MIT-like License (OpenBSD)

Permission to use, copy, modify, and distribute this software for any purpose with or without fee is hereby granted, provided that the above copyright notice and this permission notice appear in all copies.

THE SOFTWARE IS PROVIDED "AS IS" AND THE AUTHOR DISCLAIMS ALL WARRANTIES WITH REGARD TO THIS SOFTWARE INCLUDING ALL IMPLIED WARRANTIES OF MERCHANTABILITY AND FITNESS. IN NO EVENT SHALL THE AUTHOR BE LIABLE FOR ANY SPECIAL, DIRECT, INDIRECT, OR CONSEQUENTIAL DAMAGES OR ANY DAMAGES WHATSOEVER RESULTING FROM LOSS OF USE, DATA OR PROFITS, WHETHER IN AN ACTION OF CONTRACT, NEGLIGENCE OR OTHER TORTIOUS ACTION, ARISING OUT OF OR IN CONNECTION WITH THE USE OR PERFORMANCE OF THIS SOFTWARE.

MIT-like License (dri2proto)

Permission to use, copy, modify, and distribute this software for any purpose and without fee is hereby granted, provided that the above copyright notice and this permission notice appear in all copies, and that the name of Gray Watson not be used in advertising or publicity pertaining to distribution of the document or software without specific, written prior permission.

Gray Watson makes no representations about the suitability of the software described herein



for any purpose. It is provided "as is" without express or implied warranty. Permission is hereby granted, free of charge, to any person obtaining a copy of this software and associated documentation files (the "Software"), to deal in the Software without restriction, including without limitation the rights to use, copy, modify, merge, publish, distribute, and/or sell copies of the Software, and to permit persons to whom the Software is furnished to do so, provided that the above copyright notice(s) and this permission notice appear in all copies of the Software and that both the above copyright notice(s) and this permission notice appear in supporting documentation.

THE SOFTWARE IS PROVIDED "AS IS", WITHOUT WARRANTY OF ANY KIND, EXPRESS OR IMPLIED, INCLUDING BUT NOT LIMITED TO THE WARRANTIES OF MERCHANTABILITY, FITNESS FOR A PARTICULAR PURPOSE AND NONINFRINGEMENT OF THIRD PARTY RIGHTS. IN NO EVENT SHALL THE COPYRIGHT HOLDER OR HOLDERS INCLUDED IN THIS NOTICE BE LIABLE FOR ANY CLAIM, OR ANY SPECIAL INDIRECT OR CONSEQUENTIAL DAMAGES, OR ANY DAMAGES WHATSOEVER RESULTING FROM LOSS OF USE, DATA OR PROFITS, WHETHER IN AN ACTION OF CONTRACT, NEGLIGENCE OR OTHER TORTIOUS ACTION, ARISING OUT OF OR IN CONNECTION WITH THE USE OR PERFORMANCE OF THIS SOFTWARE.

Except as contained in this notice, the name of a copyright holder shall not be used in advertising or otherwise to promote the sale, use or other dealings in this Software without prior written authorization of the copyright holder.

MIT-like License (e2fsprogs)

Copyright 1987, 1988 by MIT Student Information Processing Board

Permission to use, copy, modify, and distribute this software and its documentation for any purpose is hereby granted, provided that the names of M.I.T. and the M.I.T. S.I.P.B. not be used in advertising or publicity pertaining to distribution of the software without specific, written prior permission. M.I.T. and the M.I.T. S.I.P.B. make no representations about the suitability of this software for any purpose. It is provided "as is" without express or implied warranty.

This quote is just too good to not pass on:

"BTW, I would have rejected the name Story Server because its initials are SS, the name of the secret police in Nazi Germany, probably the most despised pair of letters in western culture." --- <http://scriptingnewsarchive.userland.com/1999/12/13>

Let no one say political correctness isn't dead....



MIT-like License (fontconfig)

Permission to use, copy, modify, distribute, and sell this software and its documentation for any purpose is hereby granted without fee, provided that the above copyright notice appear in all copies and that both that copyright notice and this permission notice appear in supporting documentation, and that the name of the author(s) not be used in advertising or publicity pertaining to distribution of the software without specific, written prior permission. The authors make no representations about the suitability of this software for any purpose. It is provided "as is" without express or implied warranty.

THE AUTHOR(S) DISCLAIMS ALL WARRANTIES WITH REGARD TO THIS SOFTWARE, INCLUDING ALL IMPLIED WARRANTIES OF MERCHANTABILITY AND FITNESS, IN NO EVENT SHALL THE AUTHOR(S) BE LIABLE FOR ANY SPECIAL, INDIRECT OR CONSEQUENTIAL DAMAGES OR ANY DAMAGES WHATSOEVER RESULTING FROM LOSS OF USE, DATA OR PROFITS, WHETHER IN AN ACTION OF CONTRACT, NEGLIGENCE OR OTHER TORTIOUS ACTION, ARISING OUT OF OR IN CONNECTION WITH THE USE OR PERFORMANCE OF THIS SOFTWARE.

MIT-like License (libmowgli)

Permission to use, copy, modify, and/or distribute this software for any purpose with or without fee is hereby granted, provided that the above copyright notice and this permission notice is present in all copies.

THIS SOFTWARE IS PROVIDED BY THE COPYRIGHT HOLDERS AND CONTRIBUTORS "AS IS" AND ANY EXPRESS OR IMPLIED WARRANTIES, INCLUDING, BUT NOT LIMITED TO, THE IMPLIED WARRANTIES OF MERCHANTABILITY AND FITNESS FOR A PARTICULAR PURPOSE ARE DISCLAIMED. IN NO EVENT SHALL THE COPYRIGHT OWNER OR CONTRIBUTORS BE LIABLE FOR ANY DIRECT, INDIRECT, INCIDENTAL, SPECIAL, EXEMPLARY, OR CONSEQUENTIAL DAMAGES (INCLUDING, BUT NOT LIMITED TO, PROCUREMENT OF SUBSTITUTE GOODS OR SERVICES; LOSS OF USE, DATA, OR PROFITS; OR BUSINESS INTERRUPTION) HOWEVER CAUSED AND ON ANY THEORY OF LIABILITY, WHETHER IN CONTRACT, STRICT LIABILITY, OR TORT (INCLUDING NEGLIGENCE OR OTHERWISE) ARISING IN ANY WAY OUT OF THE USE OF THIS SOFTWARE, EVEN IF ADVISED OF THE POSSIBILITY OF SUCH DAMAGE.

MIT-like License (libxkbcommon)

The following is a list of all copyright notices and license statements which appear in the xkbcommon source tree.

If making new contributions, the first form (i.e. Daniel Stone, Ran Benita, etc) is vastly preferred.



All licenses are derivative of the MIT/X11 license, mostly identical other than no-endorsement clauses (e.g. paragraph 4 of The Open Group's license).

These statements are split into two sections: one for the code compiled and distributed as part of the libxkbcommon shared library and the code component of all tests (i.e. everything under src/ and xkbcommon/, plus the .c and .h files under test/), and another for the test data under test/data, which is distributed with the xkbcommon source tarball, but not installed to the system.

BEGINNING OF SOFTWARE COPYRIGHT/LICENSE STATEMENTS:

Copyright(c) 2009-2012 Daniel Stone
Copyright(c) 2012 Ran Benita <ran234@gmail.com>
Copyright(c) 2010, 2012 Intel Corporation
Copyright(c) 2008, 2009 Dan Nicholson
Copyright(c) 2010 Francisco Jerez <currojerez@riseup.net>

Permission is hereby granted, free of charge, to any person obtaining a copy of this software and associated documentation files (the "Software"), to deal in the Software without restriction, including without limitation the rights to use, copy, modify, merge, publish, distribute, sublicense, and/or sell copies of the Software, and to permit persons to whom the Software is furnished to do so, subject to the following conditions:

The above copyright notice and this permission notice (including the next paragraph) shall be included in all copies or substantial portions of the Software.

THE SOFTWARE IS PROVIDED "AS IS", WITHOUT WARRANTY OF ANY KIND, EXPRESS OR IMPLIED, INCLUDING BUT NOT LIMITED TO THE WARRANTIES OF MERCHANTABILITY, FITNESS FOR A PARTICULAR PURPOSE AND NONINFRINGEMENT. IN NO EVENT SHALL THE AUTHORS OR COPYRIGHT HOLDERS BE LIABLE FOR ANY CLAIM, DAMAGES OR OTHER LIABILITY, WHETHER IN AN ACTION OF CONTRACT, TORT OR OTHERWISE, ARISING FROM, OUT OF OR IN CONNECTION WITH THE SOFTWARE OR THE USE OR OTHER DEALINGS IN THE SOFTWARE.

Copyright 1985, 1987, 1988, 1990, 1998 The Open Group



Permission is hereby granted, free of charge, to any person obtaining a copy of this software and associated documentation files (the "Software"), to deal in the Software without restriction, including without limitation the rights to use, copy, modify, merge, publish, distribute, sublicense, and/or sell copies of the Software, and to permit persons to whom the Software is furnished to do so, subject to the following conditions:

The above copyright notice and this permission notice shall be included in all copies or substantial portions of the Software.

THE SOFTWARE IS PROVIDED "AS IS", WITHOUT WARRANTY OF ANY KIND, EXPRESS OR IMPLIED, INCLUDING BUT NOT LIMITED TO THE WARRANTIES OF MERCHANTABILITY, FITNESS FOR A PARTICULAR PURPOSE AND NONINFRINGEMENT. IN NO EVENT SHALL THE AUTHORS BE LIABLE FOR ANY CLAIM, DAMAGES OR OTHER LIABILITY, WHETHER IN AN ACTION OF CONTRACT, TORT OR OTHERWISE, ARISING FROM, OUT OF OR IN CONNECTION WITH THE SOFTWARE OR THE USE OR OTHER DEALINGS IN THE SOFTWARE.

Except as contained in this notice, the names of the authors or their institutions shall not be used in advertising or otherwise to promote the sale, use or other dealings in this Software without prior written authorization from the authors.

Copyright (c) 1993, 1994, 1995, 1996 by Silicon Graphics Computer Systems, Inc.

Permission to use, copy, modify, and distribute this software and its documentation for any purpose and without fee is hereby granted, provided that the above copyright notice appear in all copies and that both that copyright notice and this permission notice appear in supporting documentation, and that the name of Silicon Graphics not be used in advertising or publicity pertaining to distribution of the software without specific prior written permission.

Silicon Graphics makes no representation about the suitability of this software for any purpose. It is provided "as is" without any express or implied warranty.

SILICON GRAPHICS DISCLAIMS ALL WARRANTIES WITH REGARD TO THIS SOFTWARE, INCLUDING ALL IMPLIED WARRANTIES OF MERCHANTABILITY AND FITNESS FOR A PARTICULAR PURPOSE. IN NO EVENT SHALL SILICON GRAPHICS BE LIABLE FOR ANY SPECIAL, INDIRECT OR CONSEQUENTIAL DAMAGES OR ANY DAMAGES WHATSOEVER RESULTING FROM LOSS OF USE, DATA OR PROFITS, WHETHER IN AN ACTION OF CONTRACT, NEGLIGENCE OR OTHER TORTIOUS ACTION, ARISING OUT OF OR IN CONNECTION WITH THE USE OR PERFORMANCE OF THIS SOFTWARE.



Copyright 1987, 1988 by Digital Equipment Corporation, Maynard, Massachusetts.
All Rights Reserved

Permission to use, copy, modify, and distribute this software and its documentation for any purpose and without fee is hereby granted, provided that the above copyright notice appear in all copies and that both that copyright notice and this permission notice appear in supporting documentation, and that the name of Digital not be used in advertising or publicity pertaining to distribution of the software without specific, written prior permission.

DIGITAL DISCLAIMS ALL WARRANTIES WITH REGARD TO THIS SOFTWARE, INCLUDING ALL IMPLIED WARRANTIES OF MERCHANTABILITY AND FITNESS, IN NO EVENT SHALL DIGITAL BE LIABLE FOR ANY SPECIAL, INDIRECT OR CONSEQUENTIAL DAMAGES OR ANY DAMAGES WHATSOEVER RESULTING FROM LOSS OF USE, DATA OR PROFITS, WHETHER IN AN ACTION OF CONTRACT, NEGLIGENCE OR OTHER TORTIOUS ACTION, ARISING OUT OF OR IN CONNECTION WITH THE USE OR PERFORMANCE OF THIS SOFTWARE.

Copyright (C) 2011 Joseph Adams <joeyadams3.14159@gmail.com>

Permission is hereby granted, free of charge, to any person obtaining a copy of this software and associated documentation files (the "Software"), to deal in the Software without restriction, including without limitation the rights to use, copy, modify, merge, publish, distribute, sublicense, and/or sell copies of the Software, and to permit persons to whom the Software is furnished to do so, subject to the following conditions:

The above copyright notice and this permission notice shall be included in all copies or substantial portions of the Software.

THE SOFTWARE IS PROVIDED "AS IS", WITHOUT WARRANTY OF ANY KIND, EXPRESS OR IMPLIED, INCLUDING BUT NOT LIMITED TO THE WARRANTIES OF MERCHANTABILITY, FITNESS FOR A PARTICULAR PURPOSE AND NONINFRINGEMENT. IN NO EVENT SHALL THE AUTHORS OR COPYRIGHT HOLDERS BE LIABLE FOR ANY CLAIM, DAMAGES OR OTHER LIABILITY, WHETHER IN AN ACTION OF CONTRACT, TORT OR OTHERWISE, ARISING FROM, OUT OF OR IN CONNECTION WITH THE SOFTWARE OR THE USE OR OTHER DEALINGS IN THE SOFTWARE.

END OF SOFTWARE COPYRIGHT/LICENSE STATEMENTS



BEGINNING OF LICENSE STATEMENTS FOR UNDISTRIBUTED DATA FILES IN test/data, derived from xkeyboard-config:

Copyright 1996 by Joseph Moss
Copyright (C) 2002-2007 Free Software Foundation, Inc.
Copyright (C) Dmitry Golubev <lastguru@mail.ru>, 2003-2004
Copyright (C) 2004, Gregory Mokhin <mokhin@bog.msu.ru>
Copyright (C) 2006 Erdal Ronah

Permission to use, copy, modify, distribute, and sell this software and its documentation for any purpose is hereby granted without fee, provided that the above copyright notice appear in all copies and that both that copyright notice and this permission notice appear in supporting documentation, and that the name of the copyright holder(s) not be used in advertising or publicity pertaining to distribution of the software without specific, written prior permission.

The copyright holder(s) makes no representations about the suitability of this software for any purpose.

It is provided "as is" without express or implied warranty.

THE COPYRIGHT HOLDER(S) DISCLAIMS ALL WARRANTIES WITH REGARD TO THIS SOFTWARE, INCLUDING ALL IMPLIED WARRANTIES OF MERCHANTABILITY AND FITNESS, IN NO EVENT SHALL THE COPYRIGHT HOLDER(S) BE LIABLE FOR ANY SPECIAL, INDIRECT OR CONSEQUENTIAL DAMAGES OR ANY DAMAGES WHATSOEVER RESULTING FROM LOSS OF USE, DATA OR PROFITS, WHETHER IN AN ACTION OF CONTRACT, NEGLIGENCE OR OTHER TORTIOUS ACTION, ARISING OUT OF OR IN CONNECTION WITH THE USE OR PERFORMANCE OF THIS SOFTWARE.

MIT-like License (Isf)

This software is not subject to any license of the American Telephone and Telegraph Company or the Regents of the University of California.

Permission is granted to anyone to use this software for any purpose on any computer system, and to alter it and redistribute it freely, subject to the following restrictions:

1. Neither the authors nor Purdue University are responsible for any consequences of the use of this software.
2. The origin of this software must not be misrepresented, either by explicit claim or by omission. Credit to the authors and Purdue University must appear in documentation and



sources.

3. Altered versions must be plainly marked as such, and must not be misrepresented as being the original software.
4. This notice may not be removed or altered.

MIT-like License (ncurses)

Copyright (c) 1999-2004,2005 Free Software Foundation, Inc.

Permission is hereby granted, free of charge, to any person obtaining a copy of this software and associated documentation files (the "Software"), to deal in the Software without restriction, including without limitation the rights to use, copy, modify, merge, publish, distribute, distribute with modifications, sublicense, and/or sell copies of the Software, and to permit persons to whom the Software is furnished to do so, subject to the following conditions:

The above copyright notice and this permission notice shall be included in all copies or substantial portions of the Software.

THE SOFTWARE IS PROVIDED "AS IS", WITHOUT WARRANTY OF ANY KIND, EXPRESS OR IMPLIED, INCLUDING BUT NOT LIMITED TO THE WARRANTIES OF MERCHANTABILITY, FITNESS FOR A PARTICULAR PURPOSE AND NONINFRINGEMENT. IN NO EVENT SHALL THE ABOVE COPYRIGHT HOLDERS BE LIABLE FOR ANY CLAIM, DAMAGES OR OTHER LIABILITY, WHETHER IN AN ACTION OF CONTRACT, TORT OR OTHERWISE, ARISING FROM, OUT OF OR IN CONNECTION WITH THE SOFTWARE OR THE USE OR OTHER DEALINGS IN THE SOFTWARE.

Except as contained in this notice, the name(s) of the above copyright holders shall not be used in advertising or otherwise to promote the sale, use or other dealings in this Software without prior written authorization.

MIT-like License (sudo)

Sudo is distributed under the following license:

Copyright (c) 1994-1996, 1998-2013
Todd C. Miller <Todd.Miller@courtesan.com>



Permission to use, copy, modify, and distribute this software for any purpose with or without fee is hereby granted, provided that the above copyright notice and this permission notice appear in all copies.

THE SOFTWARE IS PROVIDED "AS IS" AND THE AUTHOR DISCLAIMS ALL WARRANTIES WITH REGARD TO THIS SOFTWARE INCLUDING ALL IMPLIED WARRANTIES OF MERCHANTABILITY AND FITNESS, IN NO EVENT SHALL THE AUTHOR BE LIABLE FOR ANY SPECIAL, DIRECT, INDIRECT, OR CONSEQUENTIAL DAMAGES OR ANY DAMAGES WHATSOEVER RESULTING FROM LOSS OF USE, DATA OR PROFITS, WHETHER IN AN ACTION OF CONTRACT, NEGLIGENCE OR OTHER TORTIOUS ACTION, ARISING OUT OF OR IN CONNECTION WITH THE USE OR PERFORMANCE OF THIS SOFTWARE.

Sponsored in part by the Defense Advanced Research Projects Agency (DARPA) and Air Force Research Laboratory, Air Force Materiel Command, USAF, under agreement number F39502-99-1-0512.

The file `redblack.c` bears the following license:

Copyright (c) 2001 Emin Martinian

Redistribution and use in source and binary forms, with or without modification, are permitted provided that neither the name of Emin Martinian nor the names of any contributors are be used to endorse or promote products derived from this software without specific prior written permission.

THIS SOFTWARE IS PROVIDED BY THE COPYRIGHT HOLDERS AND CONTRIBUTORS "AS IS" AND ANY EXPRESS OR IMPLIED WARRANTIES, INCLUDING, BUT NOT LIMITED TO, THE IMPLIED WARRANTIES OF MERCHANTABILITY AND FITNESS FOR A PARTICULAR PURPOSE ARE DISCLAIMED. IN NO EVENT SHALL THE COPYRIGHT OWNER OR CONTRIBUTORS BE LIABLE FOR ANY DIRECT, INDIRECT, INCIDENTAL, SPECIAL, EXEMPLARY, OR CONSEQUENTIAL DAMAGES (INCLUDING, BUT NOT LIMITED TO, PROCUREMENT OF SUBSTITUTE GOODS OR SERVICES; LOSS OF USE, DATA, OR PROFITS; OR BUSINESS INTERRUPTION) HOWEVER CAUSED AND ON ANY THEORY OF LIABILITY, WHETHER IN CONTRACT, STRICT LIABILITY, OR TORT (INCLUDING NEGLIGENCE OR OTHERWISE) ARISING IN ANY WAY OUT OF THE USE OF THIS SOFTWARE, EVEN IF ADVISED OF THE POSSIBILITY OF SUCH DAMAGE.

The files `getcwd.c`, `glob.c`, `glob.h` and `snprintf.c` bear the following license:

Copyright (c) 1989, 1990, 1991, 1993

The Regents of the University of California. All rights reserved.

Redistribution and use in source and binary forms, with or without modification, are permitted



provided that the following conditions are met:

1. Redistributions of source code must retain the above copyright notice, this list of conditions and the following disclaimer.
2. Redistributions in binary form must reproduce the above copyright notice, this list of conditions and the following disclaimer in the documentation and/or other materials provided with the distribution.
3. Neither the name of the University nor the names of its contributors may be used to endorse or promote products derived from this software without specific prior written permission.

THIS SOFTWARE IS PROVIDED BY THE REGENTS AND CONTRIBUTORS "AS IS" AND ANY EXPRESS OR IMPLIED WARRANTIES, INCLUDING, BUT NOT LIMITED TO, THE IMPLIED WARRANTIES OF MERCHANTABILITY AND FITNESS FOR A PARTICULAR PURPOSE ARE DISCLAIMED. IN NO EVENT SHALL THE REGENTS OR CONTRIBUTORS BE LIABLE FOR ANY DIRECT, INDIRECT, INCIDENTAL, SPECIAL, EXEMPLARY, OR CONSEQUENTIAL DAMAGES (INCLUDING, BUT NOT LIMITED TO, PROCUREMENT OF SUBSTITUTE GOODS OR SERVICES; LOSS OF USE, DATA, OR PROFITS; OR BUSINESS INTERRUPTION) HOWEVER CAUSED AND ON ANY THEORY OF LIABILITY, WHETHER IN CONTRACT, STRICT LIABILITY, OR TORT (INCLUDING NEGLIGENCE OR OTHERWISE) ARISING IN ANY WAY OUT OF THE USE OF THIS SOFTWARE, EVEN IF ADVISED OF THE POSSIBILITY OF SUCH DAMAGE.

The file `fnmatch.c` bears the following license:

Copyright (c) 2011, VMware, Inc.
All rights reserved.

Redistribution and use in source and binary forms, with or without modification, are permitted provided that the following conditions are met:

- * Redistributions of source code must retain the above copyright notice, this list of conditions and the following disclaimer.
- * Redistributions in binary form must reproduce the above copyright notice, this list of conditions and the following disclaimer in the documentation and/or other materials provided with the distribution.
- * Neither the name of the VMware, Inc. nor the names of its contributors may be used to endorse or promote products derived from this software without specific prior written permission.

THIS SOFTWARE IS PROVIDED BY THE COPYRIGHT HOLDERS AND CONTRIBUTORS "AS IS" AND ANY EXPRESS OR IMPLIED WARRANTIES, INCLUDING, BUT NOT LIMITED TO, THE IMPLIED WARRANTIES OF MERCHANTABILITY AND FITNESS FOR A PARTICULAR PURPOSE ARE DISCLAIMED. IN NO EVENT SHALL VMWARE, INC. OR CONTRIBUTORS BE LIABLE FOR ANY DIRECT, INDIRECT, INCIDENTAL, SPECIAL, EXEMPLARY, OR CONSEQUENTIAL DAMAGES (INCLUDING, BUT NOT LIMITED TO, PROCUREMENT OF SUBSTITUTE GOODS OR SERVICES;



LOSS OF USE, DATA, OR PROFITS; OR BUSINESS INTERRUPTION) HOWEVER CAUSED AND ON ANY THEORY OF LIABILITY, WHETHER IN CONTRACT, STRICT LIABILITY, OR TORT (INCLUDING NEGLIGENCE OR OTHERWISE) ARISING IN ANY WAY OUT OF THE USE OF THIS SOFTWARE, EVEN IF ADVISED OF THE POSSIBILITY OF SUCH DAMAGE.

The embedded copy of zlib bears the following license:

Copyright (C) 1995-2012 Jean-loup Gailly and Mark Adler

This software is provided 'as-is', without any express or implied warranty. In no event will the authors be held liable for any damages arising from the use of this software.

Permission is granted to anyone to use this software for any purpose, including commercial applications, and to alter it and redistribute it freely, subject to the following restrictions:

1. The origin of this software must not be misrepresented; you must not claim that you wrote the original software. If you use this software in a product, an acknowledgment in the product documentation would be appreciated but is not required.
2. Altered source versions must be plainly marked as such, and must not be misrepresented as being the original software.
3. This notice may not be removed or altered from any source distribution.

Jean-loup Gailly Mark Adler
jloup@gzip.org madler@alumni.caltech.edu

MIT-like License (util-macros)

Copyright 2005 Red Hat, Inc.

Permission to use, copy, modify, distribute, and sell this software and its documentation for any purpose is hereby granted without fee, provided that the above copyright notice appear in all copies and that both that copyright notice and this permission notice appear in supporting documentation, and that the name of Red Hat not be used in advertising or publicity pertaining to distribution of the software without specific, written prior permission. Red Hat makes no representations about the suitability of this software for any purpose. It is provided "as is" without express or implied warranty.

RED HAT DISCLAIMS ALL WARRANTIES WITH REGARD TO THIS SOFTWARE, INCLUDING ALL IMPLIED WARRANTIES OF MERCHANTABILITY AND FITNESS, IN NO EVENT SHALL RED HAT BE LIABLE FOR ANY SPECIAL, INDIRECT OR CONSEQUENTIAL DAMAGES OR ANY DAMAGES WHATSOEVER RESULTING FROM LOSS OF USE, DATA OR PROFITS, WHETHER IN AN ACTION



OF CONTRACT, NEGLIGENCE OR OTHER TORTIOUS ACTION, ARISING OUT OF OR IN CONNECTION WITH THE USE OR PERFORMANCE OF THIS SOFTWARE.

Copyright (c) 2005, 2006, Oracle and/or its affiliates. All rights reserved.

Permission is hereby granted, free of charge, to any person obtaining a copy of this software and associated documentation files (the "Software"), to deal in the Software without restriction, including without limitation the rights to use, copy, modify, merge, publish, distribute, sublicense, and/or sell copies of the Software, and to permit persons to whom the Software is furnished to do so, subject to the following conditions:

The above copyright notice and this permission notice (including the next paragraph) shall be included in all copies or substantial portions of the Software.

THE SOFTWARE IS PROVIDED "AS IS", WITHOUT WARRANTY OF ANY KIND, EXPRESS OR IMPLIED, INCLUDING BUT NOT LIMITED TO THE WARRANTIES OF MERCHANTABILITY, FITNESS FOR A PARTICULAR PURPOSE AND NONINFRINGEMENT. IN NO EVENT SHALL THE AUTHORS OR COPYRIGHT HOLDERS BE LIABLE FOR ANY CLAIM, DAMAGES OR OTHER LIABILITY, WHETHER IN AN ACTION OF CONTRACT, TORT OR OTHERWISE, ARISING FROM, OUT OF OR IN CONNECTION WITH THE SOFTWARE OR THE USE OR OTHER DEALINGS IN THE SOFTWARE.

MIT-like License (xkeyboard-config)

Copyright 1996 by Joseph Moss

Copyright (C) 2002-2007 Free Software Foundation, Inc.

Copyright (C) Dmitry Golubev <lastguru@mail.ru>, 2003-2004

Copyright (C) 2004, Gregory Mokhin <mokhin@bog.msu.ru>

Copyright (C) 2006 Erdal Ronahî

Permission to use, copy, modify, distribute, and sell this software and its documentation for any purpose is hereby granted without fee, provided that the above copyright notice appear in all copies and that both that copyright notice and this permission notice appear in supporting documentation, and that the name of the copyright holder(s) not be used in advertising or publicity pertaining to distribution of the software without specific, written prior permission. The copyright holder(s) makes no representations about the suitability of this software for any purpose. It is provided "as is" without express or implied warranty.

THE COPYRIGHT HOLDER(S) DISCLAIMS ALL WARRANTIES WITH REGARD TO THIS



SOFTWARE, INCLUDING ALL IMPLIED WARRANTIES OF MERCHANTABILITY AND FITNESS, IN NO EVENT SHALL THE COPYRIGHT HOLDER(S) BE LIABLE FOR ANY SPECIAL, INDIRECT OR CONSEQUENTIAL DAMAGES OR ANY DAMAGES WHATSOEVER RESULTING FROM LOSS OF USE, DATA OR PROFITS, WHETHER IN AN ACTION OF CONTRACT, NEGLIGENCE OR OTHER TORTIOUS ACTION, ARISING OUT OF OR IN CONNECTION WITH THE USE OR PERFORMANCE OF THIS SOFTWARE.

Copyright (c) 1996 Digital Equipment Corporation

Permission is hereby granted, free of charge, to any person obtaining a copy of this software and associated documentation files (the "Software"), to deal in the Software without restriction, including without limitation the rights to use, copy, modify, merge, publish, distribute, sublicense, and sell copies of the Software, and to permit persons to whom the Software is furnished to do so, subject to the following conditions:

The above copyright notice and this permission notice shall be included in all copies or substantial portions of the Software.

THE SOFTWARE IS PROVIDED "AS IS", WITHOUT WARRANTY OF ANY KIND, EXPRESS OR IMPLIED, INCLUDING BUT NOT LIMITED TO THE WARRANTIES OF MERCHANTABILITY, FITNESS FOR A PARTICULAR PURPOSE AND NONINFRINGEMENT. IN NO EVENT SHALL DIGITAL EQUIPMENT CORPORATION BE LIABLE FOR ANY CLAIM, DAMAGES OR OTHER LIABILITY, WHETHER IN AN ACTION OF CONTRACT, TORT OR OTHERWISE, ARISING FROM, OUT OF OR IN CONNECTION WITH THE SOFTWARE OR THE USE OR OTHER DEALINGS IN THE SOFTWARE.

Except as contained in this notice, the name of the Digital Equipment Corporation shall not be used in advertising or otherwise to promote the sale, use or other dealings in this Software without prior written authorization from Digital Equipment Corporation.

Copyright 1996, 1998 The Open Group

Permission to use, copy, modify, distribute, and sell this software and its documentation for any purpose is hereby granted without fee, provided that the above copyright notice appear in all copies and that both that copyright notice and this permission notice appear in supporting documentation.

The above copyright notice and this permission notice shall be included in all copies or substantial portions of the Software.

THE SOFTWARE IS PROVIDED "AS IS", WITHOUT WARRANTY OF ANY KIND, EXPRESS OR IMPLIED, INCLUDING BUT NOT LIMITED TO THE WARRANTIES OF MERCHANTABILITY,



FITNESS FOR A PARTICULAR PURPOSE AND NONINFRINGEMENT. IN NO EVENT SHALL THE OPEN GROUP BE LIABLE FOR ANY CLAIM, DAMAGES OR OTHER LIABILITY, WHETHER IN AN ACTION OF CONTRACT, TORT OR OTHERWISE, ARISING FROM, OUT OF OR IN CONNECTION WITH THE SOFTWARE OR THE USE OR OTHER DEALINGS IN THE SOFTWARE.

Except as contained in this notice, the name of The Open Group shall not be used in advertising or otherwise to promote the sale, use or other dealings in this Software without prior written authorization from The Open Group.

Copyright 2004-2005 Sun Microsystems, Inc. All rights reserved.

Permission is hereby granted, free of charge, to any person obtaining a copy of this software and associated documentation files (the "Software"), to deal in the Software without restriction, including without limitation the rights to use, copy, modify, merge, publish, distribute, and/or sell copies of the Software, and to permit persons to whom the Software is furnished to do so, provided that the above copyright notice(s) and this permission notice appear in all copies of the Software and that both the above copyright notice(s) and this permission notice appear in supporting documentation.

THE SOFTWARE IS PROVIDED "AS IS", WITHOUT WARRANTY OF ANY KIND, EXPRESS OR IMPLIED, INCLUDING BUT NOT LIMITED TO THE WARRANTIES OF MERCHANTABILITY, FITNESS FOR A PARTICULAR PURPOSE AND NONINFRINGEMENT OF THIRD PARTY RIGHTS. IN NO EVENT SHALL THE COPYRIGHT HOLDER OR HOLDERS INCLUDED IN THIS NOTICE BE LIABLE FOR ANY CLAIM, OR ANY SPECIAL INDIRECT OR CONSEQUENTIAL DAMAGES, OR ANY DAMAGES WHATSOEVER RESULTING FROM LOSS OF USE, DATA OR PROFITS, WHETHER IN AN ACTION OF CONTRACT, NEGLIGENCE OR OTHER TORTIOUS ACTION, ARISING OUT OF OR IN CONNECTION WITH THE USE OR PERFORMANCE OF THIS SOFTWARE.

Except as contained in this notice, the name of a copyright holder shall not be used in advertising or otherwise to promote the sale, use or other dealings in this Software without prior written authorization of the copyright holder.

Copyright (c) 1996 by Silicon Graphics Computer Systems, Inc.

Permission to use, copy, modify, and distribute this software and its documentation for any purpose and without fee is hereby granted, provided that the above copyright notice appear in all copies and that both that copyright notice and this permission notice appear in supporting documentation, and that the name of Silicon Graphics not be used in advertising or publicity pertaining to distribution of the software without specific prior written permission.

Silicon Graphics makes no representation about the suitability of this software for any purpose. It is provided "as is" without any express or implied warranty.

SILICON GRAPHICS DISCLAIMS ALL WARRANTIES WITH REGARD TO THIS SOFTWARE,



INCLUDING ALL IMPLIED WARRANTIES OF MERCHANTABILITY AND FITNESS FOR A PARTICULAR PURPOSE, IN NO EVENT SHALL SILICON GRAPHICS BE LIABLE FOR ANY SPECIAL, INDIRECT OR CONSEQUENTIAL DAMAGES OR ANY DAMAGES WHATSOEVER RESULTING FROM LOSS OF USE, DATA OR PROFITS, WHETHER IN AN ACTION OF CONTRACT, NEGLIGENCE OR OTHER TORTIOUS ACTION, ARISING OUT OF OR IN CONNECTION WITH THE USE OR PERFORMANCE OF THIS SOFTWARE.

Copyright (c) 1996 X Consortium

Permission is hereby granted, free of charge, to any person obtaining a copy of this software and associated documentation files (the "Software"), to deal in the Software without restriction, including without limitation the rights to use, copy, modify, merge, publish, distribute, sublicense, and/or sell copies of the Software, and to permit persons to whom the Software is furnished to do so, subject to the following conditions:

The above copyright notice and this permission notice shall be included in all copies or substantial portions of the Software.

THE SOFTWARE IS PROVIDED "AS IS", WITHOUT WARRANTY OF ANY KIND, EXPRESS OR IMPLIED, INCLUDING BUT NOT LIMITED TO THE WARRANTIES OF MERCHANTABILITY, FITNESS FOR A PARTICULAR PURPOSE AND NONINFRINGEMENT. IN NO EVENT SHALL THE X CONSORTIUM BE LIABLE FOR ANY CLAIM, DAMAGES OR OTHER LIABILITY, WHETHER IN AN ACTION OF CONTRACT, TORT OR OTHERWISE, ARISING FROM, OUT OF OR IN CONNECTION WITH THE SOFTWARE OR THE USE OR OTHER DEALINGS IN THE SOFTWARE.

Except as contained in this notice, the name of the X Consortium shall not be used in advertising or otherwise to promote the sale, use or other dealings in this Software without prior written authorization from the X Consortium.

Copyright (C) 2004, 2006 Ævar Arnfjörð Bjarmason <avarab@gmail.com>

Permission to use, copy, modify, distribute, and sell this software and its documentation for any purpose is hereby granted without fee, provided that the above copyright notice appear in all copies and that both that copyright notice and this permission notice appear in supporting documentation.

The above copyright notice and this permission notice shall be included in all copies or substantial portions of the Software.

THE SOFTWARE IS PROVIDED "AS IS", WITHOUT WARRANTY OF ANY KIND, EXPRESS OR IMPLIED, INCLUDING BUT NOT LIMITED TO THE WARRANTIES OF MERCHANTABILITY, FITNESS FOR A PARTICULAR PURPOSE AND NONINFRINGEMENT. IN NO EVENT SHALL THE OPEN GROUP BE LIABLE FOR ANY CLAIM, DAMAGES OR OTHER LIABILITY, WHETHER IN AN ACTION OF CONTRACT, TORT OR OTHERWISE, ARISING FROM, OUT OF OR IN CONNECTION



WITH THE SOFTWARE OR THE USE OR OTHER DEALINGS IN THE SOFTWARE.

Except as contained in this notice, the name of a copyright holder shall not be used in advertising or otherwise to promote the sale, use or other dealings in this Software without prior written authorization of the copyright holder.

Copyright (C) 1999, 2000 by Anton Zinoviev <anton@lml.bas.bg>

This software may be used, modified, copied, distributed, and sold, in both source and binary form provided that the above copyright and these terms are retained. Under no circumstances is the author responsible for the proper functioning of this software, nor does the author assume any responsibility for damages incurred with its use.

Permission is granted to anyone to use, distribute and modify this file in any way, provided that the above copyright notice is left intact and the author of the modification summarizes the changes in this header.

This file is distributed without any expressed or implied warranty.

MPL-1.1

Mozilla Public License Version 1.1

1. Definitions.

1.0.1. "Commercial Use" means distribution or otherwise making the Covered Code available to a third party.

1.1. "Contributor" means each entity that creates or contributes to the creation of Modifications.

1.2. "Contributor Version" means the combination of the Original Code, prior Modifications used by a Contributor, and the Modifications made by that particular Contributor.

1.3. "Covered Code" means the Original Code or Modifications or the combination of the Original Code and Modifications, in each case including portions thereof.

1.4. "Electronic Distribution Mechanism" means a mechanism generally accepted in the software development community for the electronic transfer of data.



1.5. "Executable" means Covered Code in any form other than Source Code.

1.6. "Initial Developer" means the individual or entity identified as the Initial Developer in the Source Code notice required by Exhibit A.

1.7. "Larger Work" means a work which combines Covered Code or portions thereof with code not governed by the terms of this License.

1.8. "License" means this document.

1.8.1. "Licensable" means having the right to grant, to the maximum extent possible, whether at the time of the initial grant or subsequently acquired, any and all of the rights conveyed herein.

1.9. "Modifications" means any addition to or deletion from the substance or structure of either the Original Code or any previous Modifications. When Covered Code is released as a series of files, a Modification is:

Any addition to or deletion from the contents of a file containing Original Code or previous Modifications.

Any new file that contains any part of the Original Code or previous Modifications.

1.10. "Original Code" means Source Code of computer software code which is described in the Source Code notice required by Exhibit A as Original Code, and which, at the time of its release under this License is not already Covered Code governed by this License.

1.10.1. "Patent Claims" means any patent claim(s), now owned or hereafter acquired, including without limitation, method, process, and apparatus claims, in any patent Licensable by grantor.

1.11. "Source Code" means the preferred form of the Covered Code for making modifications to it, including all modules it contains, plus any associated interface definition files, scripts used to control compilation and installation of an Executable, or source code differential comparisons against either the Original Code or another well known, available Covered Code of the Contributor's choice. The Source Code can be in a compressed or archival form, provided the appropriate decompression or de-archiving software is widely available for no charge.

1.12. "You" (or "Your") means an individual or a legal entity exercising rights under, and complying with all of the terms of, this License or a future version of this License issued under Section 6.1. For legal entities, "You" includes any entity which controls, is controlled by, or is under common control with You. For purposes of this definition, "control" means (a) the power, direct or indirect, to cause the direction or management of such entity, whether by



contract or otherwise, or (b) ownership of more than fifty percent (50%) of the outstanding shares or beneficial ownership of such entity.

2. Source Code License.

2.1. The Initial Developer Grant. The Initial Developer hereby grants You a world-wide, royalty-free, non-exclusive license, subject to third party intellectual property claims:

- a. under intellectual property rights (other than patent or trademark) Licensable by Initial Developer to use, reproduce, modify, display, perform, sublicense and distribute the Original Code (or portions thereof) with or without Modifications, and/or as part of a Larger Work; and
- b. under Patents Claims infringed by the making, using or selling of Original Code, to make, have made, use, practice, sell, and offer for sale, and/or otherwise dispose of the Original Code (or portions thereof).
- c. the licenses granted in this Section 2.1 (a) and (b) are effective on the date Initial Developer first distributes Original Code under the terms of this License.
- d. Notwithstanding Section 2.1 (b) above, no patent license is granted: 1) for code that You delete from the Original Code; 2) separate from the Original Code; or 3) for infringements caused by: i) the modification of the Original Code or ii) the combination of the Original Code with other software or devices.

2.2. Contributor Grant. Subject to third party intellectual property claims, each Contributor hereby grants You a world-wide, royalty-free, non-exclusive license

- a. under intellectual property rights (other than patent or trademark) Licensable by Contributor, to use, reproduce, modify, display, perform, sublicense and distribute the Modifications created by such Contributor (or portions thereof) either on an unmodified basis, with other Modifications, as Covered Code and/or as part of a Larger Work; and
- b. under Patent Claims infringed by the making, using, or selling of Modifications made by that Contributor either alone and/or in combination with its Contributor Version (or portions of such combination), to make, use, sell, offer for sale, have made, and/or otherwise dispose of: 1) Modifications made by that Contributor (or portions thereof); and 2) the combination of Modifications made by that Contributor with its Contributor Version (or portions of such combination).
- c. the licenses granted in Sections 2.2 (a) and 2.2 (b) are effective on the date Contributor first makes Commercial Use of the Covered Code.
- d. Notwithstanding Section 2.2 (b) above, no patent license is granted: 1) for any code that Contributor has deleted from the Contributor Version; 2) separate from the Contributor Version; 3) for infringements caused by: i) third party modifications of Contributor Version or ii) the combination of Modifications made by that Contributor with other software (except as part of the Contributor Version) or other devices; or 4) under Patent Claims infringed by Covered Code in the absence of Modifications made by that Contributor.



3. Distribution Obligations.

3.1. Application of License. The Modifications which You create or to which You contribute are governed by the terms of this License, including without limitation Section 2.2. The Source Code version of Covered Code may be distributed only under the terms of this License or a future version of this License released under Section 6.1, and You must include a copy of this License with every copy of the Source Code You distribute. You may not offer or impose any terms on any Source Code version that alters or restricts the applicable version of this License or the recipients' rights hereunder. However, You may include an additional document offering the additional rights described in Section 3.5.

3.2. Availability of Source Code. Any Modification which You create or to which You contribute must be made available in Source Code form under the terms of this License either on the same media as an Executable version or via an accepted Electronic Distribution Mechanism to anyone to whom you made an Executable version available; and if made available via Electronic Distribution Mechanism, must remain available for at least twelve (12) months after the date it initially became available, or at least six (6) months after a subsequent version of that particular Modification has been made available to such recipients. You are responsible for ensuring that the Source Code version remains available even if the Electronic Distribution Mechanism is maintained by a third party.

3.3. Description of Modifications. You must cause all Covered Code to which You contribute to contain a file documenting the changes You made to create that Covered Code and the date of any change. You must include a prominent statement that the Modification is derived, directly or indirectly, from Original Code provided by the Initial Developer and including the name of the Initial Developer in (a) the Source Code, and (b) in any notice in an Executable version or related documentation in which You describe the origin or ownership of the Covered Code.

3.4. Intellectual Property Matters

(a) Third Party Claims

If Contributor has knowledge that a license under a third party's intellectual property rights is required to exercise the rights granted by such Contributor under Sections 2.1 or 2.2, Contributor must include a text file with the Source Code distribution titled "LEGAL" which describes the claim and the party making the claim in sufficient detail that a recipient will know whom to contact. If Contributor obtains such knowledge after the Modification is made available as described in Section 3.2, Contributor shall promptly modify the LEGAL file in all copies Contributor makes available thereafter and shall take other steps (such as notifying appropriate mailing lists or newsgroups) reasonably calculated to inform those who received the Covered Code that new knowledge has been obtained.

(b) Contributor APIs



If Contributor's Modifications include an application programming interface and Contributor has knowledge of patent licenses which are reasonably necessary to implement that API, Contributor must also include this information in the LEGAL file.

(c) Representations.

Contributor represents that, except as disclosed pursuant to Section 3.4 (a) above, Contributor believes that Contributor's Modifications are Contributor's original creation(s) and/or Contributor has sufficient rights to grant the rights conveyed by this License.

3.5. Required Notices. You must duplicate the notice in Exhibit A in each file of the Source Code. If it is not possible to put such notice in a particular Source Code file due to its structure, then You must include such notice in a location (such as a relevant directory) where a user would be likely to look for such a notice. If You created one or more Modification(s) You may add your name as a Contributor to the notice described in Exhibit A. You must also duplicate this License in any documentation for the Source Code where You describe recipients' rights or ownership rights relating to Covered Code. You may choose to offer, and to charge a fee for, warranty, support, indemnity or liability obligations to one or more recipients of Covered Code. However, You may do so only on Your own behalf, and not on behalf of the Initial Developer or any Contributor. You must make it absolutely clear than any such warranty, support, indemnity or liability obligation is offered by You alone, and You hereby agree to indemnify the Initial Developer and every Contributor for any liability incurred by the Initial Developer or such Contributor as a result of warranty, support, indemnity or liability terms You offer.

3.6. Distribution of Executable Versions. You may distribute Covered Code in Executable form only if the requirements of Sections 3.1, 3.2, 3.3, 3.4 and 3.5 have been met for that Covered Code, and if You include a notice stating that the Source Code version of the Covered Code is available under the terms of this License, including a description of how and where You have fulfilled the obligations of Section 3.2. The notice must be conspicuously included in any notice in an Executable version, related documentation or collateral in which You describe recipients' rights relating to the Covered Code. You may distribute the Executable version of Covered Code or ownership rights under a license of Your choice, which may contain terms different from this License, provided that You are in compliance with the terms of this License and that the license for the Executable version does not attempt to limit or alter the recipient's rights in the Source Code version from the rights set forth in this License. If You distribute the Executable version under a different license You must make it absolutely clear that any terms which differ from this License are offered by You alone, not by the Initial Developer or any Contributor. You hereby agree to indemnify the Initial Developer and every Contributor for any liability incurred by the Initial Developer or such Contributor as a result of any such terms You offer.

3.7. Larger Works. You may create a Larger Work by combining Covered Code with other code not governed by the terms of this License and distribute the Larger Work as a single product. In such a case, You must make sure the requirements of this License are fulfilled for the Covered Code.



4. Inability to Comply Due to Statute or Regulation.

If it is impossible for You to comply with any of the terms of this License with respect to some or all of the Covered Code due to statute, judicial order, or regulation then You must: (a) comply with the terms of this License to the maximum extent possible; and (b) describe the limitations and the code they affect. Such description must be included in the LEGAL file described in Section 3.4 and must be included with all distributions of the Source Code. Except to the extent prohibited by statute or regulation, such description must be sufficiently detailed for a recipient of ordinary skill to be able to understand it.

5. Application of this License.

This License applies to code to which the Initial Developer has attached the notice in Exhibit A and to related Covered Code.

6. Versions of the License.

6.1. New Versions

Netscape Communications Corporation ("Netscape") may publish revised and/or new versions of the License from time to time. Each version will be given a distinguishing version number.

6.2. Effect of New Versions

Once Covered Code has been published under a particular version of the License, You may always continue to use it under the terms of that version. You may also choose to use such Covered Code under the terms of any subsequent version of the License published by Netscape. No one other than Netscape has the right to modify the terms applicable to Covered Code created under this License.

6.3. Derivative Works

If You create or use a modified version of this License (which you may only do in order to apply it to code which is not already Covered Code governed by this License), You must (a) rename Your license so that the phrases "Mozilla", "MOZILLAPL", "MOZPL", "Netscape", "MPL", "NPL" or any confusingly similar phrase do not appear in your license (except to note that your license differs from this License) and (b) otherwise make it clear that Your version of the license contains terms which differ from the Mozilla Public License and Netscape Public License. (Filling in the name of the Initial Developer, Original Code or Contributor in the notice described in Exhibit A shall not of themselves be deemed to be modifications of this License.)

7. DISCLAIMER OF WARRANTY

COVERED CODE IS PROVIDED UNDER THIS LICENSE ON AN "AS IS" BASIS, WITHOUT WARRANTY OF ANY KIND, EITHER EXPRESSED OR IMPLIED, INCLUDING, WITHOUT LIMITATION, WARRANTIES THAT THE COVERED CODE IS FREE OF DEFECTS, MERCHANTABILITY,



FIT FOR A PARTICULAR PURPOSE OR NON-INFRINGEMENT. THE ENTIRE RISK AS TO THE QUALITY AND PERFORMANCE OF THE COVERED CODE IS WITH YOU. SHOULD ANY COVERED CODE PROVE DEFECTIVE IN ANY RESPECT, YOU (NOT THE INITIAL DEVELOPER OR ANY OTHER CONTRIBUTOR) ASSUME THE COST OF ANY NECESSARY SERVICING, REPAIR OR CORRECTION. THIS DISCLAIMER OF WARRANTY CONSTITUTES AN ESSENTIAL PART OF THIS LICENSE. NO USE OF ANY COVERED CODE IS AUTHORIZED HEREUNDER EXCEPT UNDER THIS DISCLAIMER.

8. Termination

8.1. This License and the rights granted hereunder will terminate automatically if You fail to comply with terms herein and fail to cure such breach within 30 days of becoming aware of the breach. All sublicenses to the Covered Code which are properly granted shall survive any termination of this License. Provisions which, by their nature, must remain in effect beyond the termination of this License shall survive.

8.2. If You initiate litigation by asserting a patent infringement claim (excluding declaratory judgment actions) against Initial Developer or a Contributor (the Initial Developer or Contributor against whom You file such action is referred to as "Participant") alleging that:

a. such Participant's Contributor Version directly or indirectly infringes any patent, then any and all rights granted by such Participant to You under Sections 2.1 and/or 2.2 of this License shall, upon 60 days notice from Participant terminate prospectively, unless if within 60 days after receipt of notice You either: (i) agree in writing to pay Participant a mutually agreeable reasonable royalty for Your past and future use of Modifications made by such Participant, or (ii) withdraw Your litigation claim with respect to the Contributor Version against such Participant. If within 60 days of notice, a reasonable royalty and payment arrangement are not mutually agreed upon in writing by the parties or the litigation claim is not withdrawn, the rights granted by Participant to You under Sections 2.1 and/or 2.2 automatically terminate at the expiration of the 60 day notice period specified above.

b. any software, hardware, or device, other than such Participant's Contributor Version, directly or indirectly infringes any patent, then any rights granted to You by such Participant under Sections 2.1(b) and 2.2(b) are revoked effective as of the date You first made, used, sold, distributed, or had made, Modifications made by that Participant.

8.3. If You assert a patent infringement claim against Participant alleging that such Participant's Contributor Version directly or indirectly infringes any patent where such claim is resolved (such as by license or settlement) prior to the initiation of patent infringement litigation, then the reasonable value of the licenses granted by such Participant under Sections 2.1 or 2.2 shall be taken into account in determining the amount or value of any payment or license.

8.4. In the event of termination under Sections 8.1 or 8.2 above, all end user license agreements (excluding distributors and resellers) which have been validly granted by You or



any distributor hereunder prior to termination shall survive termination.

9. LIMITATION OF LIABILITY

UNDER NO CIRCUMSTANCES AND UNDER NO LEGAL THEORY, WHETHER TORT (INCLUDING NEGLIGENCE), CONTRACT, OR OTHERWISE, SHALL YOU, THE INITIAL DEVELOPER, ANY OTHER CONTRIBUTOR, OR ANY DISTRIBUTOR OF COVERED CODE, OR ANY SUPPLIER OF ANY OF SUCH PARTIES, BE LIABLE TO ANY PERSON FOR ANY INDIRECT, SPECIAL, INCIDENTAL, OR CONSEQUENTIAL DAMAGES OF ANY CHARACTER INCLUDING, WITHOUT LIMITATION, DAMAGES FOR LOSS OF GOODWILL, WORK STOPPAGE, COMPUTER FAILURE OR MALFUNCTION, OR ANY AND ALL OTHER COMMERCIAL DAMAGES OR LOSSES, EVEN IF SUCH PARTY SHALL HAVE BEEN INFORMED OF THE POSSIBILITY OF SUCH DAMAGES. THIS LIMITATION OF LIABILITY SHALL NOT APPLY TO LIABILITY FOR DEATH OR PERSONAL INJURY RESULTING FROM SUCH PARTY'S NEGLIGENCE TO THE EXTENT APPLICABLE LAW PROHIBITS SUCH LIMITATION. SOME JURISDICTIONS DO NOT ALLOW THE EXCLUSION OR LIMITATION OF INCIDENTAL OR CONSEQUENTIAL DAMAGES, SO THIS EXCLUSION AND LIMITATION MAY NOT APPLY TO YOU.

10. U.S. government end users

The Covered Code is a "commercial item," as that term is defined in 48 C.F.R. 2.101 (Oct. 1995), consisting of "commercial computer software" and "commercial computer software documentation," as such terms are used in 48 C.F.R. 12.212 (Sept. 1995). Consistent with 48 C.F.R. 12.212 and 48 C.F.R. 227.7202-1 through 227.7202-4 (June 1995), all U.S. Government End Users acquire Covered Code with only those rights set forth herein.

11. Miscellaneous

This License represents the complete agreement concerning subject matter hereof. If any provision of this License is held to be unenforceable, such provision shall be reformed only to the extent necessary to make it enforceable. This License shall be governed by California law provisions (except to the extent applicable law, if any, provides otherwise), excluding its conflict-of-law provisions. With respect to disputes in which at least one party is a citizen of, or an entity chartered or registered to do business in the United States of America, any litigation relating to this License shall be subject to the jurisdiction of the Federal Courts of the Northern District of California, with venue lying in Santa Clara County, California, with the losing party responsible for costs, including without limitation, court costs and reasonable attorneys' fees and expenses. The application of the United Nations Convention on Contracts for the International Sale of Goods is expressly excluded. Any law or regulation which provides that the language of a contract shall be construed against the drafter shall not apply to this License.

12. Responsibility for claims

As between Initial Developer and the Contributors, each party is responsible for claims and damages arising, directly or indirectly, out of its utilization of rights under this License and You agree to work with Initial Developer and Contributors to distribute such responsibility on an equitable basis. Nothing herein is intended or shall be deemed to constitute any admission of



liability.

13. Multiple-licensed code

Initial Developer may designate portions of the Covered Code as "Multiple-Licensed". "Multiple-Licensed" means that the Initial Developer permits you to utilize portions of the Covered Code under Your choice of the MPL or the alternative licenses, if any, specified by the Initial Developer in the file described in Exhibit A.

Exhibit A - Mozilla Public License.

"The contents of this file are subject to the Mozilla Public License Version 1.1 (the "License"); you may not use this file except in compliance with the License. You may obtain a copy of the License at <http://www.mozilla.org/MPL/>

Software distributed under the License is distributed on an "AS IS" basis, WITHOUT WARRANTY OF ANY KIND, either express or implied. See the License for the specific language governing rights and limitations under the License.

The Original Code is _____.

The Initial Developer of the Original Code is _____.

Portions created by _____ are Copyright (C) _____
_____. All Rights Reserved.

Contributor(s): _____.

Alternatively, the contents of this file may be used under the terms of the ____ license (the "[] License"), in which case the provisions of [] License are applicable instead of those above. If you wish to allow use of your version of this file only under the terms of the [] License and not to allow others to use your version of this file under the MPL, indicate your decision by deleting the provisions above and replace them with the notice and other provisions required by the [] License. If you do not delete the provisions above, a recipient may use your version of this file under either the MPL or the [] License."

NOTE: The text of this Exhibit A may differ slightly from the text of the notices in the Source Code files of the Original Code. You should use the text of this Exhibit A rather than the text found in the Original Code Source Code for Your Modifications.

MPL-2.0

Mozilla Public License Version 2.0



1. Definitions

1.1. "Contributor" means each individual or legal entity that creates, contributes to the creation of, or owns Covered Software.

1.2. "Contributor Version" means the combination of the Contributions of others (if any) used by a Contributor and that particular Contributor's Contribution.

1.3. "Contribution" means Covered Software of a particular Contributor.

1.4. "Covered Software" means Source Code Form to which the initial Contributor has attached the notice in Exhibit A, the Executable Form of such Source Code Form, and Modifications of such Source Code Form, in each case including portions thereof.

1.5. "Incompatible With Secondary Licenses" means

(a) that the initial Contributor has attached the notice described in Exhibit B to the Covered Software; or

(b) that the Covered Software was made available under the terms of version 1.1 or earlier of the License, but not also under the terms of a Secondary License.

1.6. "Executable Form" means any form of the work other than Source Code Form.

1.7. "Larger Work" means a work that combines Covered Software with other material, in a separate file or files, that is not Covered Software.

1.8. "License" means this document.

1.9. "Licensable" means having the right to grant, to the maximum extent possible, whether at the time of the initial grant or subsequently, any and all of the rights conveyed by this License.

1.10. "Modifications" means any of the following:

(a) any file in Source Code Form that results from an addition to, deletion from, or modification of the contents of Covered Software; or

(b) any new file in Source Code Form that contains any Covered Software.



1.11. "Patent Claims" of a Contributor means any patent claim(s), including without limitation, method, process, and apparatus claims, in any patent Licensable by such Contributor that would be infringed, but for the grant of the License, by the making, using, selling, offering for sale, having made, import, or transfer of either its Contributions or its Contributor Version.

1.12. "Secondary License" means either the GNU General Public License, Version 2.0, the GNU Lesser General Public License, Version 2.1, the GNU Affero General Public License, Version 3.0, or any later versions of those licenses.

1.13. "Source Code Form" means the form of the work preferred for making modifications.

1.14. "You" (or "Your") means an individual or a legal entity exercising rights under this License. For legal entities, "You" includes any entity that controls, is controlled by, or is under common control with You. For purposes of this definition, "control" means (a) the power, direct or indirect, to cause the direction or management of such entity, whether by contract or otherwise, or (b) ownership of more than fifty percent (50%) of the outstanding shares or beneficial ownership of such entity.

2. License Grants and Conditions

2.1. Grants

Each Contributor hereby grants You a world-wide, royalty-free, non-exclusive license:

(a) under intellectual property rights (other than patent or trademark) Licensable by such Contributor to use, reproduce, make available, modify, display, perform, distribute, and otherwise exploit its Contributions, either on an unmodified basis, with Modifications, or as part of a Larger Work; and

(b) under Patent Claims of such Contributor to make, use, sell, offer for sale, have made, import, and otherwise transfer either its Contributions or its Contributor Version.

2.2. Effective Date

The licenses granted in Section 2.1 with respect to any Contribution become effective for each Contribution on the date the Contributor first distributes such Contribution.

2.3. Limitations on Grant Scope

The licenses granted in this Section 2 are the only rights granted under this License. No additional rights or licenses will be implied from the distribution or licensing of Covered Software under this License. Notwithstanding Section 2.1(b) above, no patent license is granted by a Contributor:



(a) for any code that a Contributor has removed from Covered Software; or

(b) for infringements caused by: (i) Your and any other third party's modifications of Covered Software, or (ii) the combination of its Contributions with other software (except as part of its Contributor Version); or

(c) under Patent Claims infringed by Covered Software in the absence of its Contributions.

This License does not grant any rights in the trademarks, service marks, or logos of any Contributor (except as may be necessary to comply with the notice requirements in Section 3.4).

2.4. Subsequent Licenses

No Contributor makes additional grants as a result of Your choice to distribute the Covered Software under a subsequent version of this License (see Section 10.2) or under the terms of a Secondary License (if permitted under the terms of Section 3.3).

2.5. Representation

Each Contributor represents that the Contributor believes its Contributions are its original creation(s) or it has sufficient rights to grant the rights to its Contributions conveyed by this License.

2.6. Fair Use

This License is not intended to limit any rights You have under applicable copyright doctrines of fair use, fair dealing, or other equivalents.

2.7. Conditions

Sections 3.1, 3.2, 3.3, and 3.4 are conditions of the licenses granted in Section 2.1.

3. Responsibilities

3.1. Distribution of Source Form

All distribution of Covered Software in Source Code Form, including any Modifications that You create or to which You contribute, must be under the terms of this License. You must inform recipients that the Source Code Form of the Covered Software is governed by the terms of this License, and how they can obtain a copy of this License. You may not attempt to alter or restrict the recipients' rights in the Source Code Form.

3.2. Distribution of Executable Form

If You distribute Covered Software in Executable Form then:



(a) such Covered Software must also be made available in Source Code Form, as described in Section 3.1, and You must inform recipients of the Executable Form how they can obtain a copy of such Source Code Form by reasonable means in a timely manner, at a charge no more than the cost of distribution to the recipient; and

(b) You may distribute such Executable Form under the terms of this License, or sublicense it under different terms, provided that the license for the Executable Form does not attempt to limit or alter the recipients' rights in the Source Code Form under this License.

3.3. Distribution of a Larger Work

You may create and distribute a Larger Work under terms of Your choice, provided that You also comply with the requirements of this License for the Covered Software. If the Larger Work is a combination of Covered Software with a work governed by one or more Secondary Licenses, and the Covered Software is not Incompatible With Secondary Licenses, this License permits You to additionally distribute such Covered Software under the terms of such Secondary License(s), so that the recipient of the Larger Work may, at their option, further distribute the Covered Software under the terms of either this License or such Secondary License(s).

3.4. Notices

You may not remove or alter the substance of any license notices (including copyright notices, patent notices, disclaimers of warranty, or limitations of liability) contained within the Source Code Form of the Covered Software, except that You may alter any license notices to the extent required to remedy known factual inaccuracies.

3.5. Application of Additional Terms

You may choose to offer, and to charge a fee for, warranty, support, indemnity or liability obligations to one or more recipients of Covered Software. However, You may do so only on Your own behalf, and not on behalf of any Contributor. You must make it absolutely clear that any such warranty, support, indemnity, or liability obligation is offered by You alone, and You hereby agree to indemnify every Contributor for any liability incurred by such Contributor as a result of warranty, support, indemnity or liability terms You offer. You may include additional disclaimers of warranty and limitations of liability specific to any jurisdiction.

4. Inability to Comply Due to Statute or Regulation

If it is impossible for You to comply with any of the terms of this License with respect to some or all of the Covered Software due to statute, judicial order, or regulation then You must: (a) comply with the terms of this License to the maximum extent possible; and (b) describe the limitations and the code they affect. Such description must be placed in a text file included with all distributions of the Covered Software under this License. Except to the extent prohibited by statute or regulation, such description must be sufficiently detailed for a recipient of ordinary skill to be able to understand it.



5. Termination

5.1. The rights granted under this License will terminate automatically if You fail to comply with any of its terms. However, if You become compliant, then the rights granted under this License from a particular Contributor are reinstated (a) provisionally, unless and until such Contributor explicitly and finally terminates Your grants, and (b) on an ongoing basis, if such Contributor fails to notify You of the non-compliance by some reasonable means prior to 60 days after You have come back into compliance. Moreover, Your grants from a particular Contributor are reinstated on an ongoing basis if such Contributor notifies You of the non-compliance by some reasonable means, this is the first time You have received notice of non-compliance with this License from such Contributor, and You become compliant prior to 30 days after Your receipt of the notice.

5.2. If You initiate litigation against any entity by asserting a patent infringement claim (excluding declaratory judgment actions, counter-claims, and cross-claims) alleging that a Contributor Version directly or indirectly infringes any patent, then the rights granted to You by any and all Contributors for the Covered Software under Section 2.1 of this License shall terminate.

5.3. In the event of termination under Sections 5.1 or 5.2 above, all end user license agreements (excluding distributors and resellers) which have been validly granted by You or Your distributors under this License prior to termination shall survive termination.

6. Disclaimer of Warranty

Covered Software is provided under this License on an "as is" basis, without warranty of any kind, either expressed, implied, or statutory, including, without limitation, warranties that the Covered Software is free of defects, merchantable, fit for a particular purpose or non-infringing. The entire risk as to the quality and performance of the Covered Software is with You. Should any Covered Software prove defective in any respect, You (not any Contributor) assume the cost of any necessary servicing, repair, or correction. This disclaimer of warranty constitutes an essential part of this License. No use of any Covered Software is authorized under this License except under this disclaimer.

7. Limitation of Liability

Under no circumstances and under no legal theory, whether tort (including negligence), contract, or otherwise, shall any Contributor, or anyone who distributes Covered Software as permitted above, be liable to You for any direct, indirect, special, incidental, or consequential damages of any character including, without limitation, damages for lost profits, loss of goodwill, work stoppage, computer failure or malfunction, or any and all other commercial damages or losses, even if such party shall have been informed of the possibility of such damages. This limitation of liability shall not apply to liability for death or personal injury resulting from such party's negligence to the extent applicable law prohibits such limitation. Some jurisdictions do not allow the exclusion or limitation of incidental or consequential



damages, so this exclusion and limitation may not apply to You.

8. Litigation

Any litigation relating to this License may be brought only in the courts of a jurisdiction where the defendant maintains its principal place of business and such litigation shall be governed by laws of that jurisdiction, without reference to its conflict-of-law provisions. Nothing in this Section shall prevent a party's ability to bring cross-claims or counter-claims.

9. Miscellaneous

This License represents the complete agreement concerning the subject matter hereof. If any provision of this License is held to be unenforceable, such provision shall be reformed only to the extent necessary to make it enforceable. Any law or regulation which provides that the language of a contract shall be construed against the drafter shall not be used to construe this License against a Contributor.

10. Versions of the License

10.1. New Versions

Mozilla Foundation is the license steward. Except as provided in Section 10.3, no one other than the license steward has the right to modify or publish new versions of this License. Each version will be given a distinguishing version number.

10.2. Effect of New Versions

You may distribute the Covered Software under the terms of the version of the License under which You originally received the Covered Software, or under the terms of any subsequent version published by the license steward.

10.3. Modified Versions

If you create software not governed by this License, and you want to create a new license for such software, you may create and use a modified version of this License if you rename the license and remove any references to the name of the license steward (except to note that such modified license differs from this License).

10.4. Distributing Source Code Form that is Incompatible With Secondary Licenses

If You choose to distribute Source Code Form that is Incompatible With Secondary Licenses under the terms of this version of the License, the notice described in Exhibit B of this License must be attached.

Exhibit A - Source Code Form License Notice

This Source Code Form is subject to the terms of the Mozilla Public License, v. 2.0. If a copy of the MPL was not distributed with this file, You can obtain one at <http://mozilla.org/MPL/2.0/>.



If it is not possible or desirable to put the notice in a particular file, then You may include the notice in a location (such as a LICENSE file in a relevant directory) where a recipient would be likely to look for such a notice.

You may add additional accurate notices of copyright ownership.

Exhibit B - "Incompatible With Secondary Licenses" Notice

This Source Code Form is "Incompatible With Secondary Licenses", as defined by the Mozilla Public License, v. 2.0.

NCSA

University of Illinois/NCSA Open Source License

Copyright (c) <Year> <Owner Organization Name>. All rights reserved.

Developed by: <Name of Development Group> <Name of Institution> <URL for Development Group/Institution>

Permission is hereby granted, free of charge, to any person obtaining a copy of this software and associated documentation files (the "Software"), to deal with the Software without restriction, including without limitation the rights to use, copy, modify, merge, publish, distribute, sublicense, and/or sell copies of the Software, and to permit persons to whom the Software is furnished to do so, subject to the following conditions:

* Redistributions of source code must retain the above copyright notice, this list of conditions and the following disclaimers.

* Redistributions in binary form must reproduce the above copyright notice, this list of conditions and the following disclaimers in the documentation and/or other materials provided with the distribution.

* Neither the names of <Name of Development Group, Name of Institution>, nor the names of its contributors may be used to endorse or promote products derived from this Software without specific prior written permission.

THE SOFTWARE IS PROVIDED "AS IS", WITHOUT WARRANTY OF ANY KIND, EXPRESS OR IMPLIED, INCLUDING BUT NOT LIMITED TO THE WARRANTIES OF MERCHANTABILITY,



FITNESS FOR A PARTICULAR PURPOSE AND NONINFRINGEMENT. IN NO EVENT SHALL THE CONTRIBUTORS OR COPYRIGHT HOLDERS BE LIABLE FOR ANY CLAIM, DAMAGES OR OTHER LIABILITY, WHETHER IN AN ACTION OF CONTRACT, TORT OR OTHERWISE, ARISING FROM, OUT OF OR IN CONNECTION WITH THE SOFTWARE OR THE USE OR OTHER DEALINGS WITH THE SOFTWARE.

NICTA Public Software Licence 1.0

NICTA Public Software Licence

Version 1.0

Copyright © 2004 National ICT Australia Ltd

All rights reserved.

By this licence, National ICT Australia Ltd (NICTA) grants permission, free of charge, to any person who obtains a copy of this software and any associated documentation files ("the Software") to use and deal with the Software in source code and binary forms without restriction, with or without modification, and to permit persons to whom the Software is furnished to do so, provided that the following conditions are met:

- Redistributions of source code must retain the above copyright notice, this list of conditions and the following disclaimers.
- Redistributions in binary form must reproduce the above copyright notice, this list of conditions and the following disclaimers in the documentation and/or other materials provided with the distribution.
- The name of NICTA may not be used to endorse or promote products derived from this Software without specific prior written permission.

EXCEPT AS EXPRESSLY STATED IN THIS LICENCE AND TO THE FULL EXTENT PERMITTED BY APPLICABLE LAW, THE SOFTWARE IS PROVIDED "AS-IS" AND NICTA MAKES NO REPRESENTATIONS, WARRANTIES OR CONDITIONS OF ANY KIND, EXPRESS OR IMPLIED, INCLUDING, WITHOUT LIMITATION, ANY REPRESENTATIONS, WARRANTIES OR CONDITIONS REGARDING THE CONTENTS OR ACCURACY OF THE SOFTWARE, OR OF TITLE, MERCHANTABILITY, FITNESS FOR A PARTICULAR PURPOSE, NONINFRINGEMENT, THE ABSENCE OF LATENT OR OTHER DEFECTS, OR THE PRESENCE OR ABSENCE OF ERRORS, WHETHER OR NOT DISCOVERABLE.

TO THE FULL EXTENT PERMITTED BY APPLICABLE LAW, IN NO EVENT WILL NICTA BE LIABLE ON ANY LEGAL THEORY (INCLUDING, WITHOUT LIMITATION, NEGLIGENCE) FOR ANY LOSS OR DAMAGE WHATSOEVER, INCLUDING (WITHOUT LIMITATION) LOSS OF PRODUCTION OR OPERATION TIME, LOSS, DAMAGE OR CORRUPTION OF DATA OR RECORDS; OR LOSS OF ANTICIPATED SAVINGS, OPPORTUNITY, REVENUE, PROFIT OR GOODWILL, OR OTHER ECONOMIC LOSS; OR ANY SPECIAL, INCIDENTAL, INDIRECT, CONSEQUENTIAL, PUNITIVE



OR EXEMPLARY DAMAGES ARISING OUT OF OR IN CONNECTION WITH THIS LICENCE, THE SOFTWARE OR THE USE OF THE SOFTWARE, EVEN IF NICTA HAS BEEN ADVISED OF THE POSSIBILITY OF SUCH DAMAGES.

If applicable legislation implies warranties or conditions, or imposes obligations or liability on NICTA in respect of the Software that cannot be wholly or partly excluded, restricted or modified, NICTA's liability is limited, to the full extent permitted by the applicable legislation, at its option, to:

- a. in the case of goods, any one or more of the following:
 - i. the replacement of the goods or the supply of equivalent goods;
 - ii. the repair of the goods;
 - iii. the payment of the cost of replacing the goods or of acquiring equivalent goods;
 - iv. the payment of the cost of having the goods repaired; or
- b. in the case of services:
 - i. the supplying of the services again; or
 - ii. the payment of the cost of having the services supplied again.

OFL-1.1

SIL OPEN FONT LICENSE

Version 1.1 - 26 February 2007

PREAMBLE

The goals of the Open Font License (OFL) are to stimulate worldwide development of collaborative font projects, to support the font creation efforts of academic and linguistic communities, and to provide a free and open framework in which fonts may be shared and improved in partnership with others.

The OFL allows the licensed fonts to be used, studied, modified and redistributed freely as long as they are not sold by themselves. The fonts, including any derivative works, can be bundled, embedded, redistributed and/or sold with any software provided that any reserved names are not used by derivative works. The fonts and derivatives, however, cannot be released under any other type of license. The requirement for fonts to remain under this license does not apply to any document created using the fonts or their derivatives.

DEFINITIONS

"Font Software" refers to the set of files released by the Copyright Holder(s) under this license



and clearly marked as such. This may include source files, build scripts and documentation.

"Reserved Font Name" refers to any names specified as such after the copyright statement(s).

"Original Version" refers to the collection of Font Software components as distributed by the Copyright Holder(s).

"Modified Version" refers to any derivative made by adding to, deleting, or substituting — in part or in whole — any of the components of the Original Version, by changing formats or by porting the Font Software to a new environment.

"Author" refers to any designer, engineer, programmer, technical writer or other person who contributed to the Font Software.

PERMISSION & CONDITIONS

Permission is hereby granted, free of charge, to any person obtaining a copy of the Font Software, to use, study, copy, merge, embed, modify, redistribute, and sell modified and unmodified copies of the Font Software, subject to the following conditions:

- 1) Neither the Font Software nor any of its individual components, in Original or Modified Versions, may be sold by itself.
- 2) Original or Modified Versions of the Font Software may be bundled, redistributed and/or sold with any software, provided that each copy contains the above copyright notice and this license. These can be included either as stand-alone text files, human-readable headers or in the appropriate machine-readable metadata fields within text or binary files as long as those fields can be easily viewed by the user.
- 3) No Modified Version of the Font Software may use the Reserved Font Name(s) unless explicit written permission is granted by the corresponding Copyright Holder. This restriction only applies to the primary font name as presented to the users.
- 4) The name(s) of the Copyright Holder(s) or the Author(s) of the Font Software shall not be used to promote, endorse or advertise any Modified Version, except to acknowledge the contribution(s) of the Copyright Holder(s) and the Author(s) or with their explicit written permission.
- 5) The Font Software, modified or unmodified, in part or in whole, must be distributed entirely under this license, and must not be distributed under any other license. The requirement for fonts to remain under this license does not apply to any document created using the Font



Software.

TERMINATION

This license becomes null and void if any of the above conditions are not met.

DISCLAIMER

THE FONT SOFTWARE IS PROVIDED "AS IS", WITHOUT WARRANTY OF ANY KIND, EXPRESS OR IMPLIED, INCLUDING BUT NOT LIMITED TO ANY WARRANTIES OF MERCHANTABILITY, FITNESS FOR A PARTICULAR PURPOSE AND NONINFRINGEMENT OF COPYRIGHT, PATENT, TRADEMARK, OR OTHER RIGHT. IN NO EVENT SHALL THE COPYRIGHT HOLDER BE LIABLE FOR ANY CLAIM, DAMAGES OR OTHER LIABILITY, INCLUDING ANY GENERAL, SPECIAL, INDIRECT, INCIDENTAL, OR CONSEQUENTIAL DAMAGES, WHETHER IN AN ACTION OF CONTRACT, TORT OR OTHERWISE, ARISING FROM, OUT OF THE USE OR INABILITY TO USE THE FONT SOFTWARE OR FROM OTHER DEALINGS IN THE FONT SOFTWARE.

OpenSSL

OpenSSL License

Copyright (c) 1998-2008 The OpenSSL Project. All rights reserved.

Redistribution and use in source and binary forms, with or without modification, are permitted provided that the following conditions are met:

1. Redistributions of source code must retain the above copyright notice, this list of conditions and the following disclaimer.
2. Redistributions in binary form must reproduce the above copyright notice, this list of conditions and the following disclaimer in the documentation and/or other materials provided with the distribution.
3. All advertising materials mentioning features or use of this software must display the following acknowledgment: "This product includes software developed by the OpenSSL Project for use in the OpenSSL Toolkit. (<http://www.openssl.org/>)"
4. The names "OpenSSL Toolkit" and "OpenSSL Project" must not be used to endorse or promote products derived from this software without prior written permission. For written permission, please contact openssl-core@openssl.org.



5. Products derived from this software may not be called "OpenSSL" nor may "OpenSSL" appear in their names without prior written permission of the OpenSSL Project.

6. Redistributions of any form whatsoever must retain the following acknowledgment: "This product includes software developed by the OpenSSL Project for use in the OpenSSL Toolkit (<http://www.openssl.org/>)"

THIS SOFTWARE IS PROVIDED BY THE OpenSSL PROJECT `AS IS' AND ANY EXPRESSED OR IMPLIED WARRANTIES, INCLUDING, BUT NOT LIMITED TO, THE IMPLIED WARRANTIES OF MERCHANTABILITY AND FITNESS FOR A PARTICULAR PURPOSE ARE DISCLAIMED. IN NO EVENT SHALL THE OpenSSL PROJECT OR ITS CONTRIBUTORS BE LIABLE FOR ANY DIRECT, INDIRECT, INCIDENTAL, SPECIAL, EXEMPLARY, OR CONSEQUENTIAL DAMAGES (INCLUDING, BUT NOT LIMITED TO, PROCUREMENT OF SUBSTITUTE GOODS OR SERVICES; LOSS OF USE, DATA, OR PROFITS; OR BUSINESS INTERRUPTION) HOWEVER CAUSED AND ON ANY THEORY OF LIABILITY, WHETHER IN CONTRACT, STRICT LIABILITY, OR TORT (INCLUDING NEGLIGENCE OR OTHERWISE) ARISING IN ANY WAY OUT OF THE USE OF THIS SOFTWARE, EVEN IF ADVISED OF THE POSSIBILITY OF SUCH DAMAGE.

This product includes cryptographic software written by Eric Young (eay@cryptsoft.com). This product includes software written by Tim Hudson (tjh@cryptsoft.com).

Original SSLeay License

Copyright (C) 1995-1998 Eric Young (eay@cryptsoft.com) All rights reserved.

This package is an SSL implementation written by Eric Young (eay@cryptsoft.com). The implementation was written so as to conform with Netscapes SSL.

This library is free for commercial and non-commercial use as long as the following conditions are adhered to. The following conditions apply to all code found in this distribution, be it the RC4, RSA, lhash, DES, etc., code; not just the SSL code. The SSL documentation included with this distribution is covered by the same copyright terms except that the holder is Tim Hudson (tjh@cryptsoft.com).

Copyright remains Eric Young's, and as such any Copyright notices in the code are not to be removed. If this package is used in a product, Eric Young should be given attribution as the author of the parts of the library used. This can be in the form of a textual message at program startup or in documentation (online or textual) provided with the package.

Redistribution and use in source and binary forms, with or without modification, are permitted provided that the following conditions are met:



1. Redistributions of source code must retain the copyright notice, this list of conditions and the following disclaimer.

2. Redistributions in binary form must reproduce the above copyright notice, this list of conditions and the following disclaimer in the documentation and/or other materials provided with the distribution.

3. All advertising materials mentioning features or use of this software must display the following acknowledgement:
 "This product includes cryptographic software written by Eric Young (eay@cryptsoft.com)"
 The word 'cryptographic' can be left out if the routines from the library being used are not cryptographic related :-).

4. If you include any Windows specific code (or a derivative thereof) from the apps directory (application code) you must include an acknowledgement: "This product includes software written by Tim Hudson (tjh@cryptsoft.com)"

THIS SOFTWARE IS PROVIDED BY ERIC YOUNG ``AS IS'' AND ANY EXPRESS OR IMPLIED WARRANTIES, INCLUDING, BUT NOT LIMITED TO, THE IMPLIED WARRANTIES OF MERCHANTABILITY AND FITNESS FOR A PARTICULAR PURPOSE ARE DISCLAIMED. IN NO EVENT SHALL THE AUTHOR OR CONTRIBUTORS BE LIABLE FOR ANY DIRECT, INDIRECT, INCIDENTAL, SPECIAL, EXEMPLARY, OR CONSEQUENTIAL DAMAGES (INCLUDING, BUT NOT LIMITED TO, PROCUREMENT OF SUBSTITUTE GOODS OR SERVICES; LOSS OF USE, DATA, OR PROFITS; OR BUSINESS INTERRUPTION) HOWEVER CAUSED AND ON ANY THEORY OF LIABILITY, WHETHER IN CONTRACT, STRICT LIABILITY, OR TORT (INCLUDING NEGLIGENCE OR OTHERWISE) ARISING IN ANY WAY OUT OF THE USE OF THIS SOFTWARE, EVEN IF ADVISED OF THE POSSIBILITY OF SUCH DAMAGE.

The licence and distribution terms for any publically available version or derivative of this code cannot be changed. i.e. this code cannot simply be copied and put under another distribution licence [including the GNU Public Licence.]

Python-2.0

PYTHON SOFTWARE FOUNDATION LICENSE VERSION 2

1. This LICENSE AGREEMENT is between the Python Software Foundation ("PSF"), and the Individual or Organization ("Licensee") accessing and otherwise using this software ("Python") in source or binary form and its associated documentation.



2. Subject to the terms and conditions of this License Agreement, PSF hereby grants Licensee a nonexclusive, royalty-free, world-wide license to reproduce, analyze, test, perform and/ or display publicly, prepare derivative works, distribute, and otherwise use Python alone or in any derivative version, provided, however, that PSF's License Agreement and PSF's notice of copyright, i.e., "Copyright (c) 2001, 2002, 2003, 2004, 2005, 2006 Python Software Foundation; All Rights Reserved" are retained in Python alone or in any derivative version prepared by Licensee.

3. In the event Licensee prepares a derivative work that is based on or incorporates Python or any part thereof, and wants to make the derivative work available to others as provided herein, then Licensee hereby agrees to include in any such work a brief summary of the changes made to Python.

4. PSF is making Python available to Licensee on an "AS IS" basis. PSF MAKES NO REPRESENTATIONS OR WARRANTIES, EXPRESS OR IMPLIED. BY WAY OF EXAMPLE, BUT NOT LIMITATION, PSF MAKES NO AND DISCLAIMS ANY REPRESENTATION OR WARRANTY OF MERCHANTABILITY OR FITNESS FOR ANY PARTICULAR PURPOSE OR THAT THE USE OF PYTHON WILL NOT INFRINGE ANY THIRD PARTY RIGHTS.

5. PSF SHALL NOT BE LIABLE TO LICENSEE OR ANY OTHER USERS OF PYTHON FOR ANY INCIDENTAL, SPECIAL, OR CONSEQUENTIAL DAMAGES OR LOSS AS A RESULT OF MODIFYING, DISTRIBUTING, OR OTHERWISE USING PYTHON, OR ANY DERIVATIVE THEREOF, EVEN IF ADVISED OF THE POSSIBILITY THEREOF.

6. This License Agreement will automatically terminate upon a material breach of its terms and conditions.

7. Nothing in this License Agreement shall be deemed to create any relationship of agency, partnership, or joint venture between PSF and Licensee. This License Agreement does not grant permission to use PSF trademarks or trade name in a trademark sense to endorse or promote products or services of Licensee, or any third party.

8. By copying, installing or otherwise using Python, Licensee agrees to be bound by the terms and conditions of this License Agreement.

BEOPEN.COM LICENSE AGREEMENT FOR PYTHON 2.0

BEOPEN PYTHON OPEN SOURCE LICENSE AGREEMENT VERSION 1

1. This LICENSE AGREEMENT is between BeOpen.com ("BeOpen"), having an office at 160 Saratoga Avenue, Santa Clara, CA 95051, and the Individual or Organization ("Licensee") accessing and otherwise using this software in source or binary form and its associated documentation ("the Software").



2. Subject to the terms and conditions of this BeOpen Python License Agreement, BeOpen hereby grants Licensee a non-exclusive, royalty-free, world-wide license to reproduce, analyze, test, perform and/or display publicly, prepare derivative works, distribute, and otherwise use the Software alone or in any derivative version, provided, however, that the BeOpen Python License is retained in the Software, alone or in any derivative version prepared by Licensee.

3. BeOpen is making the Software available to Licensee on an "AS IS" basis. BEOPEN MAKES NO REPRESENTATIONS OR WARRANTIES, EXPRESS OR IMPLIED. BY WAY OF EXAMPLE, BUT NOT LIMITATION, BEOPEN MAKES NO AND DISCLAIMS ANY REPRESENTATION OR WARRANTY OF MERCHANTABILITY OR FITNESS FOR ANY PARTICULAR PURPOSE OR THAT THE USE OF THE SOFTWARE WILL NOT INFRINGE ANY THIRD PARTY RIGHTS.

4. BEOPEN SHALL NOT BE LIABLE TO LICENSEE OR ANY OTHER USERS OF THE SOFTWARE FOR ANY INCIDENTAL, SPECIAL, OR CONSEQUENTIAL DAMAGES OR LOSS AS A RESULT OF USING, MODIFYING OR DISTRIBUTING THE SOFTWARE, OR ANY DERIVATIVE THEREOF, EVEN IF ADVISED OF THE POSSIBILITY THEREOF.

5. This License Agreement will automatically terminate upon a material breach of its terms and conditions.

6. This License Agreement shall be governed by and interpreted in all respects by the law of the State of California, excluding conflict of law provisions. Nothing in this License Agreement shall be deemed to create any relationship of agency, partnership, or joint venture between BeOpen and Licensee. This License Agreement does not grant permission to use BeOpen trademarks or trade names in a trademark sense to endorse or promote products or services of Licensee, or any third party. As an exception, the "BeOpen Python" logos available at <http://www.pythonlabs.com/logos.html> may be used according to the permissions granted on that web page.

7. By copying, installing or otherwise using the software, Licensee agrees to be bound by the terms and conditions of this License Agreement.

CNRI OPEN SOURCE LICENSE AGREEMENT (for Python 1.6b1)

IMPORTANT: PLEASE READ THE FOLLOWING AGREEMENT CAREFULLY.

BY CLICKING ON "ACCEPT" WHERE INDICATED BELOW, OR BY COPYING, INSTALLING OR OTHERWISE USING PYTHON 1.6, beta 1 SOFTWARE, YOU ARE DEEMED TO HAVE AGREED TO THE TERMS AND CONDITIONS OF THIS LICENSE AGREEMENT.

1. This LICENSE AGREEMENT is between the Corporation for National Research Initiatives,



having an office at 1895 Preston White Drive, Reston, VA 20191 ("CNRI"), and the Individual or Organization ("Licensee") accessing and otherwise using Python 1.6, beta 1 software in source or binary form and its associated documentation, as released at the www.python.org Internet site on August 4, 2000 ("Python 1.6b1").

2. Subject to the terms and conditions of this License Agreement, CNRI hereby grants Licensee a non-exclusive, royalty-free, world-wide license to reproduce, analyze, test, perform and/or display publicly, prepare derivative works, distribute, and otherwise use Python 1.6b1 alone or in any derivative version, provided, however, that CNRI's License Agreement is retained in Python 1.6b1, alone or in any derivative version prepared by Licensee.

Alternately, in lieu of CNRI's License Agreement, Licensee may substitute the following text (omitting the quotes): "Python 1.6, beta 1, is made available subject to the terms and conditions in CNRI's License Agreement. This Agreement may be located on the Internet using the following unique, persistent identifier (known as a handle): 1895.22/1011. This Agreement may also be obtained from a proxy server on the Internet using the URL:<http://hdl.handle.net/1895.22/1011>".

3. In the event Licensee prepares a derivative work that is based on or incorporates Python 1.6b1 or any part thereof, and wants to make the derivative work available to the public as provided herein, then Licensee hereby agrees to indicate in any such work the nature of the modifications made to Python 1.6b1.

4. CNRI is making Python 1.6b1 available to Licensee on an "AS IS" basis. CNRI MAKES NO REPRESENTATIONS OR WARRANTIES, EXPRESS OR IMPLIED. BY WAY OF EXAMPLE, BUT NOT LIMITATION, CNRI MAKES NO AND DISCLAIMS ANY REPRESENTATION OR WARRANTY OF MERCHANTABILITY OR FITNESS FOR ANY PARTICULAR PURPOSE OR THAT THE USE OF PYTHON 1.6b1 WILL NOT INFRINGE ANY THIRD PARTY RIGHTS.

5. CNRI SHALL NOT BE LIABLE TO LICENSEE OR ANY OTHER USERS OF THE SOFTWARE FOR ANY INCIDENTAL, SPECIAL, OR CONSEQUENTIAL DAMAGES OR LOSS AS A RESULT OF USING, MODIFYING OR DISTRIBUTING PYTHON 1.6b1, OR ANY DERIVATIVE THEREOF, EVEN IF ADVISED OF THE POSSIBILITY THEREOF.

6. This License Agreement will automatically terminate upon a material breach of its terms and conditions.

7. This License Agreement shall be governed by and interpreted in all respects by the law of the State of Virginia, excluding conflict of law provisions. Nothing in this License Agreement shall be deemed to create any relationship of agency, partnership, or joint venture between CNRI and Licensee. This License Agreement does not grant permission to use CNRI trademarks or trade name in a trademark sense to endorse or promote products or services of Licensee, or any third party.



8. By clicking on the "ACCEPT" button where indicated, or by copying, installing or otherwise using Python 1.6b1, Licensee agrees to be bound by the terms and conditions of this License Agreement.

ACCEPT

CWI LICENSE AGREEMENT FOR PYTHON 0.9.0 THROUGH 1.2

Copyright (c) 1991 - 1995, Stichting Mathematisch Centrum Amsterdam, The Netherlands. All rights reserved.

Permission to use, copy, modify, and distribute this software and its documentation for any purpose and without fee is hereby granted, provided that the above copyright notice appear in all copies and that both that copyright notice and this permission notice appear in supporting documentation, and that the name of Stichting Mathematisch Centrum or CWI not be used in advertising or publicity pertaining to distribution of the software without specific, written prior permission.

STICHTING MATHEMATISCH CENTRUM DISCLAIMS ALL WARRANTIES WITH REGARD TO THIS SOFTWARE, INCLUDING ALL IMPLIED WARRANTIES OF MERCHANTABILITY AND FITNESS, IN NO EVENT SHALL STICHTING MATHEMATISCH CENTRUM BE LIABLE FOR ANY SPECIAL, INDIRECT OR CONSEQUENTIAL DAMAGES OR ANY DAMAGES WHATSOEVER RESULTING FROM LOSS OF USE, DATA OR PROFITS, WHETHER IN AN ACTION OF CONTRACT, NEGLIGENCE OR OTHER TORTIOUS ACTION, ARISING OUT OF OR IN CONNECTION WITH THE USE OR PERFORMANCE OF THIS SOFTWARE.

SGI-B-2.0

SGI FREE SOFTWARE LICENSE B

(Version 2.0, Sept. 18, 2008)

Copyright (C) [dates of first publication] Silicon Graphics, Inc. All Rights Reserved.

Permission is hereby granted, free of charge, to any person obtaining a copy of this software and associated documentation files (the "Software"), to deal in the Software without restriction, including without limitation the rights to use, copy, modify, merge, publish, distribute, sublicense, and/or sell copies of the Software, and to permit persons to whom the Software is furnished to do so, subject to the following conditions:

The above copyright notice including the dates of first publication and either this permission notice or a reference to <http://oss.sgi.com/projects/FreeB/> shall be included in all copies or



substantial portions of the Software.

THE SOFTWARE IS PROVIDED "AS IS", WITHOUT WARRANTY OF ANY KIND, EXPRESS OR IMPLIED, INCLUDING BUT NOT LIMITED TO THE WARRANTIES OF MERCHANTABILITY, FITNESS FOR A PARTICULAR PURPOSE AND NONINFRINGEMENT. IN NO EVENT SHALL SILICON GRAPHICS, INC. BE LIABLE FOR ANY CLAIM, DAMAGES OR OTHER LIABILITY, WHETHER IN AN ACTION OF CONTRACT, TORT OR OTHERWISE, ARISING FROM, OUT OF OR IN CONNECTION WITH THE SOFTWARE OR THE USE OR OTHER DEALINGS IN THE SOFTWARE.

Except as contained in this notice, the name of Silicon Graphics, Inc. shall not be used in advertising or otherwise to promote the sale, use or other dealings in this Software without prior written authorization from Silicon Graphics, Inc.

TCL

This software is copyrighted by the Regents of the AUTHORS. The following terms apply to all files associated with the software unless explicitly disclaimed in individual files.

The authors hereby grant permission to use, copy, modify, distribute, and license this software and its documentation for any purpose, provided that existing copyright notices are retained in all copies and that this notice is included verbatim in any distributions. No written agreement, license, or royalty fee is required for any of the authorized uses. Modifications to this software may be copyrighted by their authors and need not follow the licensing terms described here, provided that the new terms are clearly indicated on the first page of each file where they apply.

IN NO EVENT SHALL THE AUTHORS OR DISTRIBUTORS BE LIABLE TO ANY PARTY FOR DIRECT, INDIRECT, SPECIAL, INCIDENTAL, OR CONSEQUENTIAL DAMAGES ARISING OUT OF THE USE OF THIS SOFTWARE, ITS DOCUMENTATION, OR ANY DERIVATIVES THEREOF, EVEN IF THE AUTHORS HAVE BEEN ADVISED OF THE POSSIBILITY OF SUCH DAMAGE.

THE AUTHORS AND DISTRIBUTORS SPECIFICALLY DISCLAIM ANY WARRANTIES, INCLUDING, BUT NOT LIMITED TO, THE IMPLIED WARRANTIES OF MERCHANTABILITY, FITNESS FOR A PARTICULAR PURPOSE, AND NON-INFRINGEMENT. THIS SOFTWARE IS PROVIDED ON AN "AS IS" BASIS, AND THE AUTHORS AND DISTRIBUTORS HAVE NO OBLIGATION TO PROVIDE MAINTENANCE, SUPPORT, UPDATES, ENHANCEMENTS, OR MODIFICATIONS.

GOVERNMENT USE: If you are acquiring this software on behalf of the U.S. government, the Government shall have only "Restricted Rights" in the software and related documentation as defined in the Federal Acquisition Regulations (FARs) in Clause 52.227.19 (c) (2). If you are acquiring the software on behalf of the Department of Defense, the software shall be classified as "Commercial Computer Software" and the Government shall have only "Restricted Rights" as defined in Clause 252.227-7013 (c) (1) of DFARs. Notwithstanding the foregoing,



the authors grant the U.S. Government and others acting in its behalf permission to use and distribute the software in accordance with the terms specified in this license.

X11

Permission is hereby granted, free of charge, to any person obtaining a copy of this software and associated documentation files (the "Software"), to deal in the Software without restriction, including without limitation the rights to use, copy, modify, merge, publish, distribute, sublicense, and/or sell copies of the Software, and to permit persons to whom the Software is furnished to do so, subject to the following conditions:

The above copyright notice and this permission notice shall be included in all copies or substantial portions of the Software.

THE SOFTWARE IS PROVIDED "AS IS", WITHOUT WARRANTY OF ANY KIND, EXPRESS OR IMPLIED, INCLUDING BUT NOT LIMITED TO THE WARRANTIES OF MERCHANTABILITY, FITNESS FOR A PARTICULAR PURPOSE AND NONINFRINGEMENT. IN NO EVENT SHALL THE AUTHORS OR COPYRIGHT HOLDERS BE LIABLE FOR ANY CLAIM, DAMAGES OR OTHER LIABILITY, WHETHER IN AN ACTION OF CONTRACT, TORT OR OTHERWISE, ARISING FROM, OUT OF OR IN CONNECTION WITH THE SOFTWARE OR THE USE OR OTHER DEALINGS IN THE SOFTWARE.

Except as contained in this notice, the name of the authors or copyright holders shall not be used in advertising or otherwise to promote the sale, use or other dealings in this Software without prior written authorization from the authors or copyright holders.

Zlib

zlib License

This software is provided 'as-is', without any express or implied warranty. In no event will the authors be held liable for any damages arising from the use of this software.

Permission is granted to anyone to use this software for any purpose, including commercial applications, and to alter it and redistribute it freely, subject to the following restrictions:

1. The origin of this software must not be misrepresented; you must not claim that you wrote the original software. If you use this software in a product, an acknowledgment in the product documentation would be appreciated but is not required.
2. Altered source versions must be plainly marked as such, and must not be misrepresented as



being the original software.

3. This notice may not be removed or altered from any source distribution.

bzip2-1.0.6

This program, "bzip2", the associated library "libbzip2", and all documentation, are copyright (C) 1996-2010 Julian R Seward. All rights reserved.

Redistribution and use in source and binary forms, with or without modification, are permitted provided that the following conditions are met:

1. Redistributions of source code must retain the above copyright notice, this list of conditions and the following disclaimer.
2. The origin of this software must not be misrepresented; you must not claim that you wrote the original software. If you use this software in a product, an acknowledgment in the product documentation would be appreciated but is not required.
3. Altered source versions must be plainly marked as such, and must not be misrepresented as being the original software.
4. The name of the author may not be used to endorse or promote products derived from this software without specific prior written permission.

THIS SOFTWARE IS PROVIDED BY THE AUTHOR ``AS IS" AND ANY EXPRESS OR IMPLIED WARRANTIES, INCLUDING, BUT NOT LIMITED TO, THE IMPLIED WARRANTIES OF MERCHANTABILITY AND FITNESS FOR A PARTICULAR PURPOSE ARE DISCLAIMED. IN NO EVENT SHALL THE AUTHOR BE LIABLE FOR ANY DIRECT, INDIRECT, INCIDENTAL, SPECIAL, EXEMPLARY, OR CONSEQUENTIAL DAMAGES (INCLUDING, BUT NOT LIMITED TO, PROCUREMENT OF SUBSTITUTE GOODS OR SERVICES; LOSS OF USE, DATA, OR PROFITS; OR BUSINESS INTERRUPTION) HOWEVER CAUSED AND ON ANY THEORY OF LIABILITY, WHETHER IN CONTRACT, STRICT LIABILITY, OR TORT (INCLUDING NEGLIGENCE OR OTHERWISE) ARISING IN ANY WAY OUT OF THE USE OF THIS SOFTWARE, EVEN IF ADVISED OF THE POSSIBILITY OF SUCH DAMAGE.

Julian Seward, jseward@bzip.org bzip2/libbzip2 version 1.0.6 of 6 September 2010

curl



Copyright (c) 1996 - 2015, Daniel Stenberg, <daniel@haxx.se>.
All rights reserved.

Permission to use, copy, modify, and distribute this software for any purpose with or without fee is hereby granted, provided that the above copyright notice and this permission notice appear in all copies.

THE SOFTWARE IS PROVIDED "AS IS", WITHOUT WARRANTY OF ANY KIND, EXPRESS OR IMPLIED, INCLUDING BUT NOT LIMITED TO THE WARRANTIES OF MERCHANTABILITY, FITNESS FOR A PARTICULAR PURPOSE AND NONINFRINGEMENT OF THIRD PARTY RIGHTS. IN NO EVENT SHALL THE AUTHORS OR COPYRIGHT HOLDERS BE LIABLE FOR ANY CLAIM, DAMAGES OR OTHER LIABILITY, WHETHER IN AN ACTION OF CONTRACT, TORT OR OTHERWISE, ARISING FROM, OUT OF OR IN CONNECTION WITH THE SOFTWARE OR THE USE OR OTHER DEALINGS IN THE SOFTWARE.

Except as contained in this notice, the name of a copyright holder shall not be used in advertising or otherwise to promote the sale, use or other dealings in this Software without prior written authorization of the copyright holder.

libtiff

Permission to use, copy, modify, distribute, and sell this software and its documentation for any purpose is hereby granted without fee, provided that (i) the above copyright notices and this permission notice appear in all copies of the software and related documentation, and (ii) the names of Sam Leffler and Silicon Graphics may not be used in any advertising or publicity relating to the software without the specific, prior written permission of Sam Leffler and Silicon Graphics.

THE SOFTWARE IS PROVIDED "AS-IS" AND WITHOUT WARRANTY OF ANY KIND, EXPRESS, IMPLIED OR OTHERWISE, INCLUDING WITHOUT LIMITATION, ANY WARRANTY OF MERCHANTABILITY OR FITNESS FOR A PARTICULAR PURPOSE.

IN NO EVENT SHALL SAM LEFFLER OR SILICON GRAPHICS BE LIABLE FOR ANY SPECIAL, INCIDENTAL, INDIRECT OR CONSEQUENTIAL DAMAGES OF ANY KIND, OR ANY DAMAGES WHATSOEVER RESULTING FROM LOSS OF USE, DATA OR PROFITS, WHETHER OR NOT ADVISED OF THE POSSIBILITY OF DAMAGE, AND ON ANY THEORY OF LIABILITY, ARISING OUT OF OR IN CONNECTION WITH THE USE OR PERFORMANCE OF THIS SOFTWARE.

xinetd

ORIGINAL LICENSE: This software is



(c) Copyright 1992 by Panagiotis Tsirigotis

The author (Panagiotis Tsirigotis) grants permission to use, copy, and distribute this software and its documentation for any purpose and without fee, provided that the above copyright notice extant in files in this distribution is not removed from files included in any redistribution and that this copyright notice is also included in any redistribution.

Modifications to this software may be distributed, either by distributing the modified software or by distributing patches to the original software, under the following additional terms:

1. The version number will be modified as follows:

- a. The first 3 components of the version number (i.e <number>.<number>.<number>) will remain unchanged.
- b. A new component will be appended to the version number to indicate the modification level. The form of this component is up to the author of the modifications.

2. The author of the modifications will include his/her name by appending it along with the new version number to this file and will be responsible for any wrong behavior of the modified software.

The author makes no representations about the suitability of this software for any purpose. It is provided "as is" without any express or implied warranty.

Modifications: Version: 2.1.8.7-current Copyright 1998-2001 by Rob Braun

Sensor Addition Version: 2.1.8.9pre14a Copyright 2001 by Steve Grubb

This is an excerpt from an email I received from the original author, allowing xinetd as maintained by me (Rob Braun), to use the higher version numbers:

I appreciate your maintaining the version string guidelines as specified in the copyright. But I did not mean them to last as long as they did.

So, if you want, you may use any 2.N.* (N >= 3) version string for future xinetd versions that you release. Note that I am excluding the 2.2.* line; using that would only create confusion. Naming the next release 2.3.0 would put to rest the confusion about 2.2.1 and 2.1.8.*.



GENESIS